

INVESTITOR: **TERME TUHELJ d.o.o.,**
Ljudevita Gaja 4,
49215 Tuheljske Toplice
OIB: 56566580479,

GRAĐEVINA: **REKONSTRUKCIJA TERMALNOG**
REKREACIJSKOG CENTRA
TERME TUHELJ

LOKACIJA: **k.č.br. 3199/1 k.o. Črešnjevec**

ZOP: **98-1-2/23**

BR. PROJEKTA: **TD 1906-06-IP-2**

MAPA: **MAPA III**

DIO: **DIO 1 – BAZENSKA DVORANA**
DIO 2 – RESTORAN I RECEPCIJA

FAZA: **IZVEDBENI PROJEKT**

VRSTA: **GRAĐEVINSKI PROJEKT**

GRAĐEVINSKI PROJEKT KONSTRUKCIJE BETONSKA KONSTRUKCIJA PLANOVI SAVIJANJA ARMATURE

GLAVNI PROJEKTANT: **Tomislav Vreš, dipl.ing.arh.**
br. ovlaštenja: A3627

PROJEKTANT KONSTRUKCIJE: **Antonio Maglov, dipl. ing. građ.**
br. ovlaštenja: G3775

SURADNICI: **Ana Majstorović, univ.mag.ing.aedif.**
Dorijan Sabljak, univ.mag.ing.aedif.
Lea Vlašić, univ.mag.ing.aedif.

DIREKTOR: **Antonio Maglov, dipl. ing. građ.**

SADRŽAJ

1. OPĆI PRILOZI

- Popis mapa izvedbenog projekta
- Izvadak iz registracije poduzeća
- Rješenje o upisu u Imenik ovlaštenih inženjera

2. ARMATURNI NACRTI

DILATACIJA 1

- ARM – TK – 101 – ARMATURA TEMELJNE KONSTRUKCIJE
- ARM – TK – 101 - ISKAZ
- ARM – E-2 – 101 – ARMATURA PLOČE E-2
- ARM – E-2 – 101 - ISKAZ
- ARM – E-2 – 102 – ARMATURA ZIDOVA I STUPOVA
- ARM – E-2 – 102 - ISKAZ

DILATACIJA 2

- ARM – TK – 201 – ARMATURA TEMELJNE KONSTRUKCIJE DONJA ZONA
- ARM – TK – 202 – ARMATURA TEMELJNE KONSTRUKCIJE GORNJA ZONA
- ARM – TK – 203 – ARMATURA TEMELJNE KONSTRUKCIJE ANKERI, PROBOJ, RUBNA ARMATURA
- ARM – TK – 201-203 - ISKAZ
- ARM – E-2 – 201 – ARMATURA GREDA
- ARM – E-2 – 201 - ISKAZ
- ARM – E-2 – 202 – ARMATURA DONJE ZONE
- ARM – E-2 – 203 – ARMATURA GORNJE ZONE
- ARM – E-2 – 204 – RUBNA ARMATURA I KAPITELI
- ARM – E-2 – 202-204 - ISKAZ
- ARM – E-2 – 205 – ARMATURA STUPOVA
- ARM – E-2 – 205 - ISKAZ
- ARM – E-2 – 206 – ARMATURA ZIDOVA – ZIDOVI 1/2
- ARM – E-2 – 207 – ARMATURA ZIDOVA – ZIDOVI 2/2
- ARM – E-2 – 206-207 - ISKAZ

DILATACIJA 3

- ARM – TK-3 – 301 – ARMATURA TEMELJNE KONSTRUKCIJE
- ARM – TK-3 – 301 - ISKAZ
- ARM – TK-2 – 301 – ARMATURA TEMELJNE KONSTRUKCIJE DONJA ZONA 1/2
- ARM – TK-2 – 302 – ARMATURA TEMELJNE KONSTRUKCIJE DONJA ZONA 2/2
- ARM – TK-2 – 303 – ARMATURA TEMELJNE KONSTRUKCIJE GORNJA ZONA 1/2
- ARM – TK-2 – 304 – ARMATURA TEMELJNE KONSTRUKCIJE GORNJA ZONA 2/2
- ARM – TK-2 – 305 – ARMATURA TEMELJNE KONSTRUKCIJE RUBNA ARMATURA 1/2
- ARM – TK-2 – 306 – ARMATURA TEMELJNE KONSTRUKCIJE RUBNA ARMATURA 2/2
- ARM – TK-2 – 307 – ARMATURA TEMELJNE KONSTRUKCIJE ANKERI, PROBOJNA, KONSTRUKTIVNA 1/2
- ARM – TK-2 – 308 – ARMATURA TEMELJNE KONSTRUKCIJE ANKERI, PROBOJNA, KONSTRUKTIVNA 2/2
- ARM – TK-2 – 301-308 - ISKAZ
- ARM – TK-2 – 321 – ARMATURA FONTANE
- ARM – TK-2 – 322 – ARMATURA STROJARNICE FONTANE

- ARM – E-2 – 321-322 - ISKAZ
- ARM – TK-2 – 323 – ARMATURA DIZALA
- ARM – TK-2 – 323 - ISKAZ
- ARM – TK-2 – 324 – ARMATURA OKOLIŠA 1
- ARM – TK-2 – 324 - ISKAZ
- ARM – E-2 – 301 – RUBNA ARMATURA I DONJA ZONA
- ARM – E-2 – 302 – RUBNA ARMATURA I DONJA ZONA
- ARM – E-2 – 303 – RUBNA ARMATURA I DONJA ZONA
- ARM – E-2 – 304 – RUBNA ARMATURA I DONJA ZONA
- ARM – E-2 – 305 – ARMATURA GORNJE ZONE
- ARM – E-2 – 306 – ARMATURA GORNJE ZONE
- ARM – E-2 – 307 – ARMATURA GORNJE ZONE
- ARM – E-2 – 308 – ARMATURA GORNJE ZONE
- ARM – E-2 – 301-308 - ISKAZ
- ARM – E-2 – 309 – ARMATURA STUBIŠTA KOD OSI 3.1
- ARM – E-2 – 309 - ISKAZ
- ARM – E-2 – 311 – ARMATURA ZIDOVA
- ARM – E-2 – 311- ISKAZ
- ARM – E-2 – 312 – ARMATURA ZIDOVA
- ARM – E-2 – 313 – ARMATURA ZIDOVA
- ARM – E-2 – 314 – ARMATURA ZIDOVA
- ARM – E-2 – 312-314 - ISKAZ
- ARM – E-2 – 321 – ARMATURA STUPOVA DILATACIJE 3
- ARM – E-2 – 321 - ISKAZ
- ARM – E-3 – 351 – ARMATURA STUBIŠTA
- ARM – E-2 – 352 – ARMATURA STUBIŠTA OKOLIŠA
- ARM – E-3 – 351-352 - ISKAZ
- ARM – E-1 – 301 – ARMATURA STROPNE PLOČE E-1, GREDE E-1
- ARM – E-1 – 301 – RUBNA ARMATURA I DONJA ZONA 1/2
- ARM – E-1 – 302 – RUBNA ARMATURA I DONJA ZONA 2/2
- ARM – E-1 – 304 – ARMATURA GORNJE ZONE 1/2
- ARM – E-1 – 305 – ARMATURA GORNJE ZONE 2/2
- ARM – E-1 – 306 – ARMATURA KAPITELA
- ARM – E-1 – 301-306 - ISKAZ

DILATACIJA 4

- ARM – TK – 401 – ARMATURA TEMELJNE KONSTRUKCIJE
- ARM – TK – 401 – ISKAZ
- ARM – E-2 – 401 – ARMATURA DONJE, GORNJE ZONE, RUBNE ARMATURE
- ARM – E-2 – 401 – ISKAZ
- ARM – E-2 – 402 – ARMATURA ZIDOVA I STUPOVA
- ARM – E-2 – 402 – ISKAZ

1. OPĆI PRILOZI

Popis mapa izvedbenog projekta

PREGLED SVIH MAPA

MAPA I	ARHITEKTONSKI PROJEKT I PROJEKT UNUTARNJEG UREĐENJA I OPREMANJA
---------------	--

Projektant	MIKELIĆ VREŠ ARHITEKTI d.o.o. Tomislav Vreš, dipl. ing. arh.
------------	---

Broj projekta	98-1-2-IZ/23
---------------	--------------

MAPA II	PROJEKT KRAJOBRAZNOG UREĐENJA
----------------	--------------------------------------

Projektant	STUDIO SOL LANDSCAPE & ARCHITECTURE j.d.o.o. Stanislava Odrlijin, mag. ing. arch.
------------	--

Broj projekta	1/23
---------------	------

MAPA III	GRAĐEVINSKI PROJEKT KONSTRUKCIJE BETONSKA KONSTRUKCIJA
-----------------	---

Projektant	KONSTRUKTA d.o.o. Antonio Maglov, dipl. ing. građ.
------------	---

Broj projekta	T.D. 1906-06-IP-2
---------------	-------------------

MAPA IV	GRAĐEVINSKI PROJEKT KONSTRUKCIJE ČELIČNA I DRVENA KONSTRUKCIJA
----------------	---

Projektant	Ured OIG Mirko Lež Mirko Lež, dipl. ing. građ.
------------	---

Broj projekta	TD 12/23
---------------	----------

Izvadak iz registracije poduzeća

REPUBLIKA HRVATSKA
TRGOVAČKI SUD U ZAGREBU

IZVADAK IZ SUDSKOG REGISTRA

SUBJEKT UPISA

MBS:

080505281

OIB:

06674378579

TVRTKA:

4 KONSTRUKTA d.o.o. za graditeljstvo

4 KONSTRUKTA d.o.o.

SJEDIŠTE/ADRESA:

2 Zagreb (Grad Zagreb)
Desinička 20

PRAVNI OBLIK:

1 društvo s ograničenom odgovornošću

PREDMET POSLOVANJA:

1	70	- Poslovanje nekretninama
1	*	- Građenje, projektiranje i nadzor
1	*	- Kupnja i prodaja robe
1	*	- Obavljanje trgovačkog posredovanja na domaćem i inozemnom tržištu
1	*	- Obavljanje investicijskih radova u inozemstvu i povjeravanje investicijskih radova stranoj osobi u RH
1	*	- Zastupanje inozemnih tvrtki
6	*	- djelatnost energetskog certificiranja i energetskog pregleda zgrade
7	*	- savjetovanje u vezi s poslovanjem i upravljanjem
7	*	- organiziranje sajmova, priredbi, kongresa, promocija, zabavnih manifestacija, seminara, tečajeva, tribina i revija

OSNIVAČI/ČLANOVI DRUŠTVA:

3 Janko Šimanović, OIB: 66223427341
Zagreb, Magdićeve stube 1

4 - član društva

4 Antonio Maglov, OIB: 75189555710
Zagreb, Ede Murtića 6

4 - član društva

OSOBE OVLAŠTENE ZA ZASTUPANJE:

4 Antonio Maglov, OIB: 75189555710
Zagreb, Ede Murtića 6

4 - direktor

D004, 2018-02-13 08:50:16

Stranica: 1



SUBJEKT UPISA

OSOBE OVLAŠTENE ZA ZASTUPANJE:

- 4 - zastupa pojedinačno i samostalno, postao član uprave-
direktor Odlukom članova društva od 06.12.2012. godine

- 4 Janko Šimanović, OIB: 66223427341
Zagreb, Magdićeve stube 1
- 4 - prokurist

TEMELJNI KAPITAL:

- 5 720.000,00 kuna

PRAVNI ODNOSI:

Osnivački akt:

- 1 Društveni ugovor o osnivanju društva s ograničenom odgovornošću od 22.listopada 2004.godine.
- 3 Odlukom jedinog člana društva od 19.srpnja 2007.god. izmijenjen je Društveni ugovor od 22.listopada 2004.god. u preambuli - odredbe o osnivačima, čl.8.-odredbe o temeljnim ulozima i poslovnim udjelima a cijeli društveni ugovor stavljen je izvan snage i preimenovan u Izjavu o osnivanju koja se u tekstu od 19.srpnja 2007.god. dostavlja sudu i ulaže u zbirku isprava.
- 4 Izjava o osnivanju društva 19.07.2007. godine izmijenjena je odlukom članova društva od 06.12.2012. godine u potpunosti i preimenovana u Društveni ugovor, koji je u cijelosti dostavljen sudu i uložen u zbirku isprava.
- 5 Odlukom članova Društva od 19.03.2013.godine izmijenjen je Društveni ugovor u pogledu odredbe o temeljnom kapitalu i članovima društva - čl. 4. i 5., te je utvrđen potpuni tekst Društvenog ugovora koji je dostavljen sudu i uložen u zbirku isprava.
- 6 Odlukom članova društva od 31.01.2014. godine izmijenjen je Društveni ugovor u pogledu odredbe o predmetu poslovanja - čl. 3. i prijelaznim i završnim odredbama - čl. 24.-26. Tekst Društvenog ugovora dostavljen je sudu i uložen u zbirku isprava.
- 7 Odlukom članova društva od 15.12.2015. godine izmijenjen je Društveni ugovor u pogledu odredbe o predmetu poslovanja - čl.3., brisan je čl.21., a čl.22.-25. su postali čl.21.-24. Potpuni tekst Društvenog ugovora od 15.12.2015. godine dostavljen sudu u zbirku isprava.

Promjene temeljnog kapitala:

- 5 Odlukom članova Društva od 19.03.2013.godine povećan je temeljni kapital sa iznosa od 20.000,00 kuna za iznos od 700.000,00 kuna na iznos od 720.000,00 kuna, pretvaranjem rezervi iz dobiti u temeljni kapital.

FINANCIJSKA IZVJEŠĆA:

Predano	God.	Za razdoblje	Vrsta izvješća
eu 27.03.17	2016	01.01.16 - 31.12.16	GFI-ROD izvješćaj

D004, 2018-02-13 08:50:16

Stranica: 2 od 2



REPUBLIKA HRVATSKA
TRGOVAČKI SUD U ZAGREBU

IZVADAK IZ SUDSKOG REGISTRA

SUBJEKT UPISA

Upise u glavnu knjigu proveli su:

RBU Tt	Datum	Naziv suda
0001 Tt-04/10466-4	17.11.2004	Trgovački sud u Zagrebu
0002 Tt-06/10597-2	17.10.2006	Trgovački sud u Zagrebu
0003 Tt-07/8585-2	28.08.2007	Trgovački sud u Zagrebu
0004 Tt-12/19136-4	21.12.2012	Trgovački sud u Zagrebu
0005 Tt-13/9213-2	16.04.2013	Trgovački sud u Zagrebu
0006 Tt-14/3094-2	06.02.2014	Trgovački sud u Zagrebu
0007 Tt-15/37071-2	22.12.2015	Trgovački sud u Zagrebu
eu /	04.07.2009	elektronički upis
eu /	14.06.2010	elektronički upis
eu /	23.03.2011	elektronički upis
eu /	28.03.2012	elektronički upis
eu /	26.03.2013	elektronički upis
eu /	24.03.2014	elektronički upis
eu /	23.03.2015	elektronički upis
eu /	04.03.2016	elektronički upis
eu /	27.03.2017	elektronički upis

U Zagrebu, 13. veljače 2018.



Rješenje o upisu u Imenik ovlaštenih inženjera



REPUBLIKA HRVATSKA
HRVATSKA KOMORA ARHITEKATA
I INŽENJERA U GRADITELJSTVU

Klasa: UP/I-360-01/06-01/ 3775
Urbroj: 314-02-06-1
Zagreb, 17. srpnja 2006. godine

Na temelju članka 24. i članka 26. stavka 2. Zakona o Hrvatskoj komori arhitekata i inženjera u graditeljstvu ("Narodne novine", br. 47/98), Statuta Hrvatske komore arhitekata i inženjera u graditeljstvu ("Narodne novine", br. 147/05), te na temelju Odluke i nacрта Rješenja Odbora za upis u Imenik ovlaštenih inženjera građevinarstva od 12.07.2006. godine, koji je rješavao po Zahtjevu za upis **MAGLOV ANTONIA**, dipl.ing.građ., ZAGREB, ZINKE KUNC 3 A, predsjednik Hrvatske komore arhitekata i inženjera u graditeljstvu donosi i potpisuje

RJEŠENJE

1. U **Imenik ovlaštenih inženjera građevinarstva** upisuje se **MAGLOV ANTONIO**, dipl.ing.građ., ZAGREB, pod rednim brojem **3775**, s danom upisa **12.07.2006.** godine.
2. Upisom u **Imenik ovlaštenih inženjera građevinarstva**, **MAGLOV ANTONIO**, dipl.ing.građ., stječe pravo na uporabu strukovnog naziva "**ovlašteni inženjer građevinarstva**" i pravo na obavljanje stručnih poslova temeljem članka 25. Zakona o Hrvatskoj komori arhitekata i inženjera u graditeljstvu, a u svezi s člankom 4. stavkom 1., 4. i 5. Statuta Hrvatske komore arhitekata i inženjera u graditeljstvu, te ostala prava i dužnosti sukladno posebnim propisima.
3. Ovlašteni inženjer građevinarstva poslove iz točke 2. ovoga Rješenja dužan je obavljati stvarno i stalno, te sukladno temeljnim načelima i pravilima struke koje treba poštivati ovlašteni inženjer građevinarstva.
4. Ovlaštenom inženjeru građevinarstva Hrvatska komora arhitekata i inženjera u graditeljstvu izdaje "**inženjersku iskaznicu**" i "**pečat**", koji su trajno vlasništvo Komore.
5. Ovlašteni inženjer građevinarstva dobiva posredstvom Hrvatske komore arhitekata i inženjera u graditeljstvu policu osiguranja od profesionalne odgovornosti od odabranog osiguravatelja. Polica se izdaje za razdoblje od godinu dana i obnavlja svake godine. Premija osiguranja uračunata je u članarinu.
6. Ovlašteni inženjer građevinarstva dužan je plaćati Hrvatskoj komori arhitekata i inženjera u graditeljstvu članarinu i ostala davanja koja utvrde tijela Komore i Razreda, osim u slučaju mirovanja članstva, te pri prestanku članstva u Komori podmiriti sve dospjele financijske obveze prema istima.

Obrazloženje

MAGLOV ANTONIO, dipl.ing.građ., podnio je Zahtjev za upis u Imenik ovlaštenih inženjera građevinarstva.

Odbor za upis u Imenik ovlaštenih inženjera građevinarstva proveo je na sjednici održanoj 12.07.2006. godine postupak razmatranja dostavljenog potpunog Zahtjeva imenovanog, te je temeljem članka 24. stavka 2. i članka 26. stavka 2. Zakona o Hrvatskoj komori arhitekata i inženjera u graditeljstvu ("Narodne novine", br. 47/98), a u svezi s člankom 5. stavkom 2. i člankom 22. Statuta Hrvatske komore arhitekata i inženjera u graditeljstvu ("Narodne novine", br. 147/05), donio Odluku i nacrt Rješenja o upisu imenovanog u Imenik ovlaštenih inženjera građevinarstva. Nacrt Rješenja dostavljen je na potpis predsjedniku Komore.

Ovlašteni inženjer građevinarstva stekao je pravo na obavljanje poslova projektiranja i/ili stručnog nadzora građenja prema članku 49. Zakona o gradnji ("Narodne novine", br. 175/03 i 100/04) i članku 4. stavku 1. Statuta Hrvatske komore arhitekata i inženjera u graditeljstvu ("Narodne novine", br. 147/05), u svojstvu odgovorne osobe upisom u Imenik ovlaštenih inženjera građevinarstva Hrvatske komore arhitekata i inženjera u graditeljstvu i to pravo mu traje dok traje policica osiguranja od profesionalne odgovornosti, odnosno do izricanja stegovne kazne iz članka 30. Zakona o Hrvatskoj komori arhitekata i inženjera u graditeljstvu ("Narodne novine", br. 47/98), a u svezi s člankom 4. stavkom 4. i 5. Statuta Hrvatske komore arhitekata i inženjera u graditeljstvu ("Narodne novine", br. 147/05).

Ovlašteni inženjer građevinarstva, osim u slučaju mirovanja članstva, dobiva posredstvom Hrvatske komore arhitekata i inženjera u graditeljstvu policu osiguranja od profesionalne odgovornosti od odabranog osiguravatelja. Polica se izdaje za razdoblje od godinu dana i obnavlja svake godine. Premija osiguranja uračunata je u članarinu.

Upisom u Imenik ovlaštenih inženjera građevinarstva imenovani je stekao pravo na "pečat" i "inženjersku iskaznicu" koje mu izdaje Hrvatska komora arhitekata i inženjera u graditeljstvu, a koji su trajno vlasništvo Komore temeljem članka 4. stavka 2. i 3. Statuta Hrvatske komore arhitekata i inženjera u graditeljstvu ("Narodne novine", br. 147/05).

Sva prethodno navedena prava obvezuju ovlaštenog inženjera građevinarstva na redovno i uredno plaćanje članarine u skladu s člankom 31. Statuta Hrvatske komore arhitekata i inženjera u graditeljstvu ("Narodne novine", br. 147/05).

Ovlašteni inženjer građevinarstva može poslove projektiranja i/ili stručnog nadzora građenja prema članku 51., 52., 53. i 55. Zakona o gradnji ("Narodne novine", br. 175/03 i 100/04) obavljati samostalno u vlastitom uredu, zajedničkom uredu, projektantskom društvu, odnosno u pravnoj osobi registriranoj za tu djelatnost.

Ovlašteni inženjer građevinarstva dužan je u obavljanju poslova projektiranja i/ili stručnog nadzora građenja poštivati odredbe Zakona o gradnji i posebnih zakona, te osigurati da obavljanje poslova projektiranja i/ili stručnog nadzora bude u skladu s načelima i pravilima struke, koja treba poštivati ovlašteni inženjer građevinarstva.

Na temelju svega prethodno navedenog, riješeno je kao u dispozitivu ovoga Rješenja.

Pouka o pravnom lijeku

Protiv ovog Rješenja žalba nije dopuštena, ali se može pokrenuti upravni spor podnošenjem tužbe Upravnom sudu Republike Hrvatske, u roku od 30 dana od primitka ovog Rješenja.













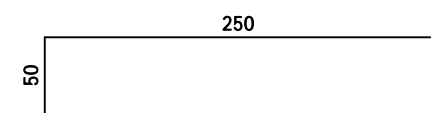
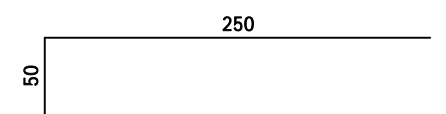

Dostaviti:

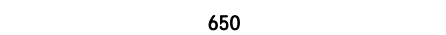
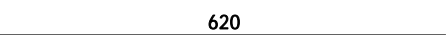
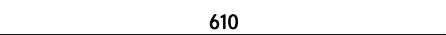
1. ANTONIO MAGLOV, 10000 ZAGREB, ZINKE KUNC 3 A
2. U Zbirku isprava Komore
3. Pismohrana Komore

17

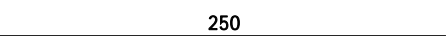
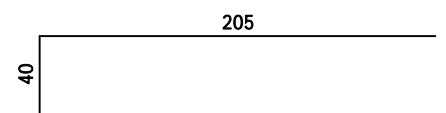
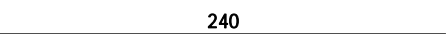
2. ARMATURNI NACRTI

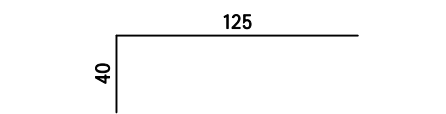
ISKAZ ARMATURE		
GRAĐEVINA:	REKONSTRUKCIJA TERMALNOG REK. CENT. TERME TUHELJ	
ISKAZ UZ NACRT:	ARM-TK-3-301	
SADRŽAJ:	ARMATURA TEMELJA -3	
DATUM:	24/06/2023	1/5

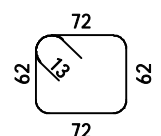
Šipke - specifikacija						
ozn	oblik i mjere [cm]	Ø	lg [m]	n [kom]	lgn [m]	Napomena
TK_DIL3_ (1 kom)						
1		25	3.00	14	42.00	
2		20	3.00	14	42.00	
3		16	12.00	25	300.00	
4		16	8.00	5	40.00	
5		16	7.55	5	37.75	
6		16	7.50	10	75.00	
7		16	6.50	6	39.00	
8		16	6.20	5	31.00	
9		16	6.10	5	30.50	
10		16	5.40	18	97.20	
11		16	5.00	4	20.00	
12		16	4.80	10	48.00	
13		16	4.60	6	27.60	
14		16	2.50	8	20.00	
15		16	2.45	20	49.00	
16		16	2.40	13	31.20	
17		16	1.80	5	9.00	
18		16	1.65	96	158.40	
19		16	1.50	4	6.00	
20		16	0.40	18	7.20	
21		12	2.94	7	20.58	

ISKAZ ARMATURE

GRAĐEVINA:	REKONSTRUKCIJA TERMALNOG REK. CENT. TERME TUHELJ	
ISKAZ UZ NACRT:	ARM-TK-3-301	
SADRŽAJ:	ARMATURA TEMELJA -3	
DATUM:	24/06/2023	2/5

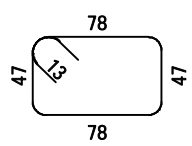
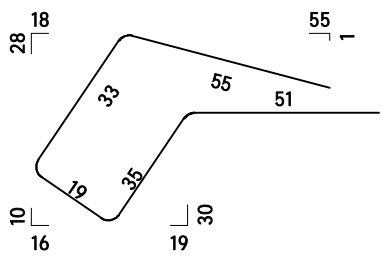
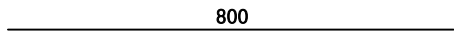
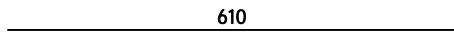
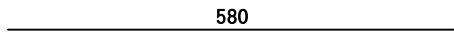
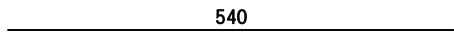
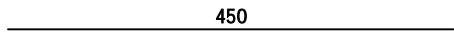
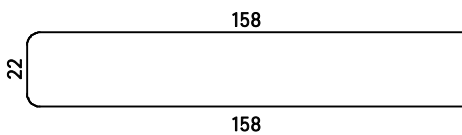
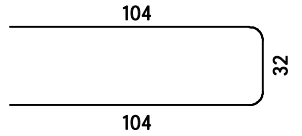
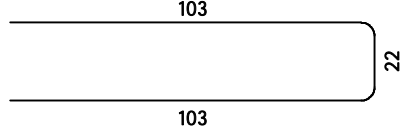
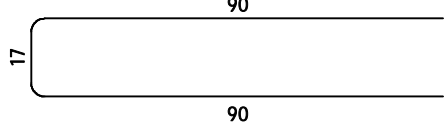
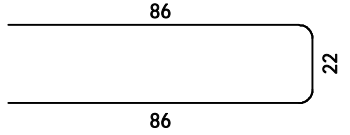
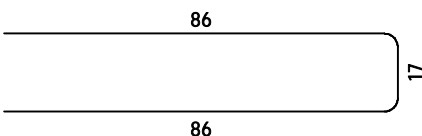
Šipke - specifikacija						
ozn	oblik i mjere [cm]	Ø	lg [m]	n [kom]	lgn [m]	Napomena
22		12	2.76	7	19.32	
23		12	1.93	5	9.65	
24		10	8.00	4	32.00	
25		10	6.10	4	24.40	
26		10	5.80	12	69.60	
27		10	5.40	4	21.60	
28		10	4.50	4	18.00	
29		10	3.38	73	246.74	
30		10	2.40	220	528.00	
31		10	2.28	40	91.20	
32		10	1.97	36	70.92	
33		10	1.94	462	896.28	
34		10	1.89	35	66.15	

ISKAZ ARMATURE

GRAĐEVINA:	REKONSTRUKCIJA TERMALNOG REK. CENT. TERME TUHELJ		
ISKAZ UZ NACRT:	ARM-TK-3-301		
SADRŽAJ:	ARMATURA TEMELJA -3		
DATUM:	24/06/2023		3/5

Šipke - specifikacija						
ozn	oblik i mjere [cm]	Ø	lg [m]	n [kom]	lgn [m]	Napomena
35		10	1.85	700	1295.00	
36		10	1.83	24	43.92	
37		10	1.20	22	26.40	
38		8	1.16	450	522.00	

ISKAZ ARMATURE		
GRAĐEVINA:	REKONSTRUKCIJA TERMALNOG REK. CENT. TERME TUHELJ	
ISKAZ UZ NACRT:	ARM-TK-3-301	
SADRŽAJ:	ARMATURA TEMELJA -3	
DATUM:	24/06/2023	4/5

Šipke - rekapitulacija			
Ø [mm]	lgn [m]	Jedinična težina [kg/m ¹]	Težina [kg]
B500B			
8	522.00	0.40	206.19
10	3430.21	0.62	2116.44
12	49.55	0.89	44.00
16	1026.85	1.58	1622.42
20	42.00	2.47	103.74
25	42.00	3.85	161.70
Ukupno (B500B)			4254.49
Ukupno			4254.49

ISKAZ ARMATURE		
GRAĐEVINA:	REKONSTRUKCIJA TERMALNOG REK. CENT. TERME TUHELJ	
ISKAZ UZ NACRT:	ARM-TK-3-301	
SADRŽAJ:	ARMATURA TEMELJA -3	
DATUM:	24/06/2023	5/5

Mreže - specifikacija							
Pozicija	Oznaka mreže	B [cm]	L [cm]	n	Jedinična težina [kg/m2]	Ukupna težina [kg]	Napomena
TK_DIL3_ (1 kom)							
1-1	Q-524	215	45	1	8.31	8.04	
1-2	Q-524	215	460	3	8.31	246.56	
1-3	Q-524	215	460	1	8.31	82.19	
1-4	Q-524	215	460	2	8.31	164.37	
1-5	Q-524	207	460	1	8.31	78.96	
1-8	Q-524	215	460	1	8.31	82.16	
1-9	Q-524	215	460	2	8.31	164.37	
1-10	Q-524	215	460	8	8.31	657.49	
1-11	Q-524	215	460	1	8.31	82.19	
1-12	Q-524	215	502	7	8.31	627.93	
1-13	Q-524	93	502	1	8.31	38.98	
1-14	Q-524	215	120	2	8.31	42.88	
1-15	Q-524	85	120	1	8.31	8.50	
1-16	Q-524	166	460	1	8.31	63.65	
1-17	Q-524	215	460	7	8.31	575.30	
1-18	Q-524	215	510	6	8.31	546.27	
1-19	Q-524	215	460	3	8.31	246.56	
1-20	Q-524	93	510	1	8.31	39.57	
1-21	Q-524	215	460	1	8.31	82.19	
1-22	Q-524	215	460	3	8.31	246.56	
1-24	Q-524	85	460	1	8.31	32.49	
1-25	Q-524	215	510	1	8.31	91.04	
2-1	Q-257	215	120	2	4.12	21.26	
2-2	Q-257	85	120	1	4.12	4.21	
Ukupno						4233.70	

NACRT SAVIJANJA ARMATURE TEMELJA TK-2 DILATACIJA 3 ARMATURA DONJE ZONE 1/2, M 1:50

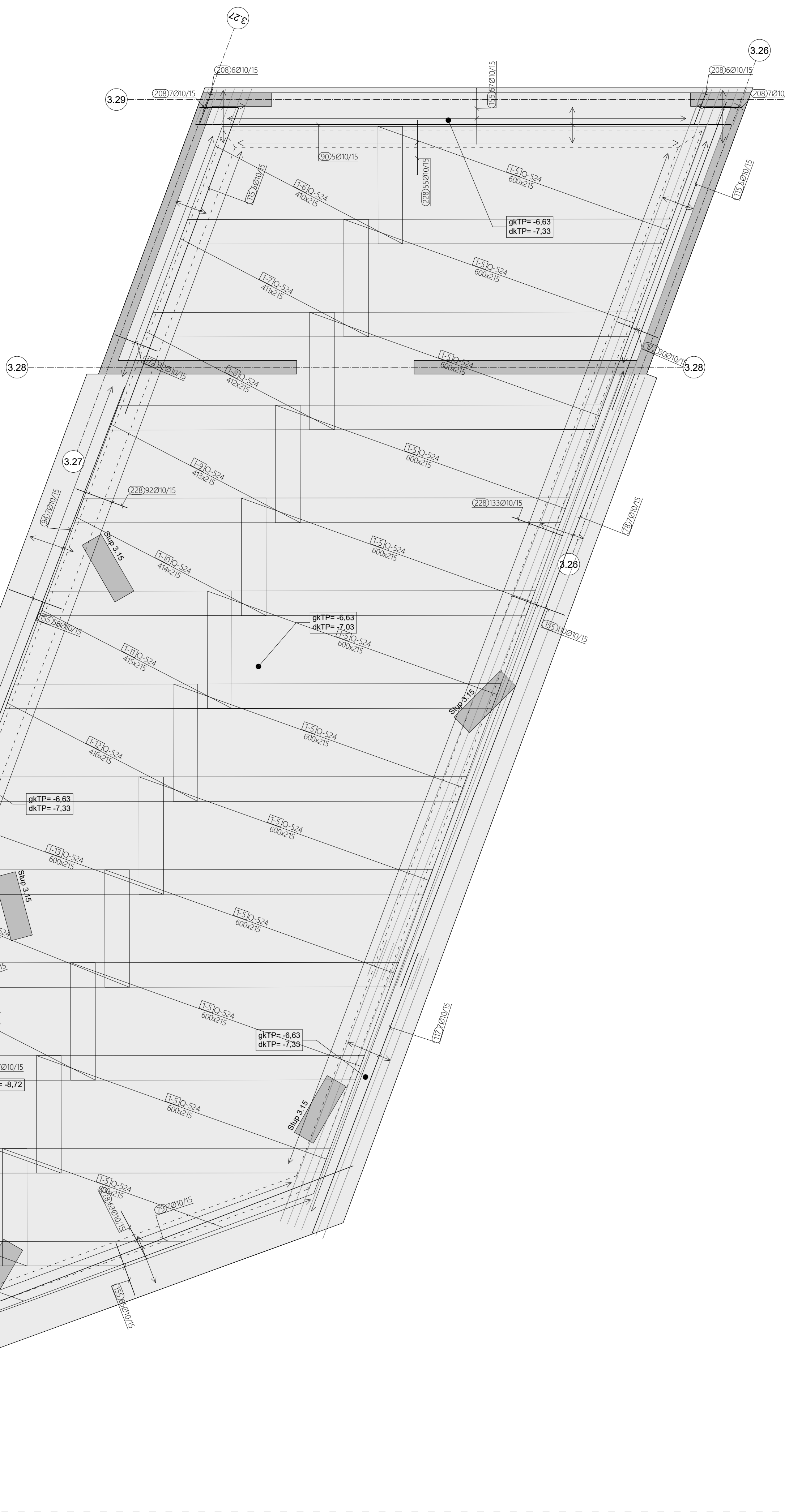
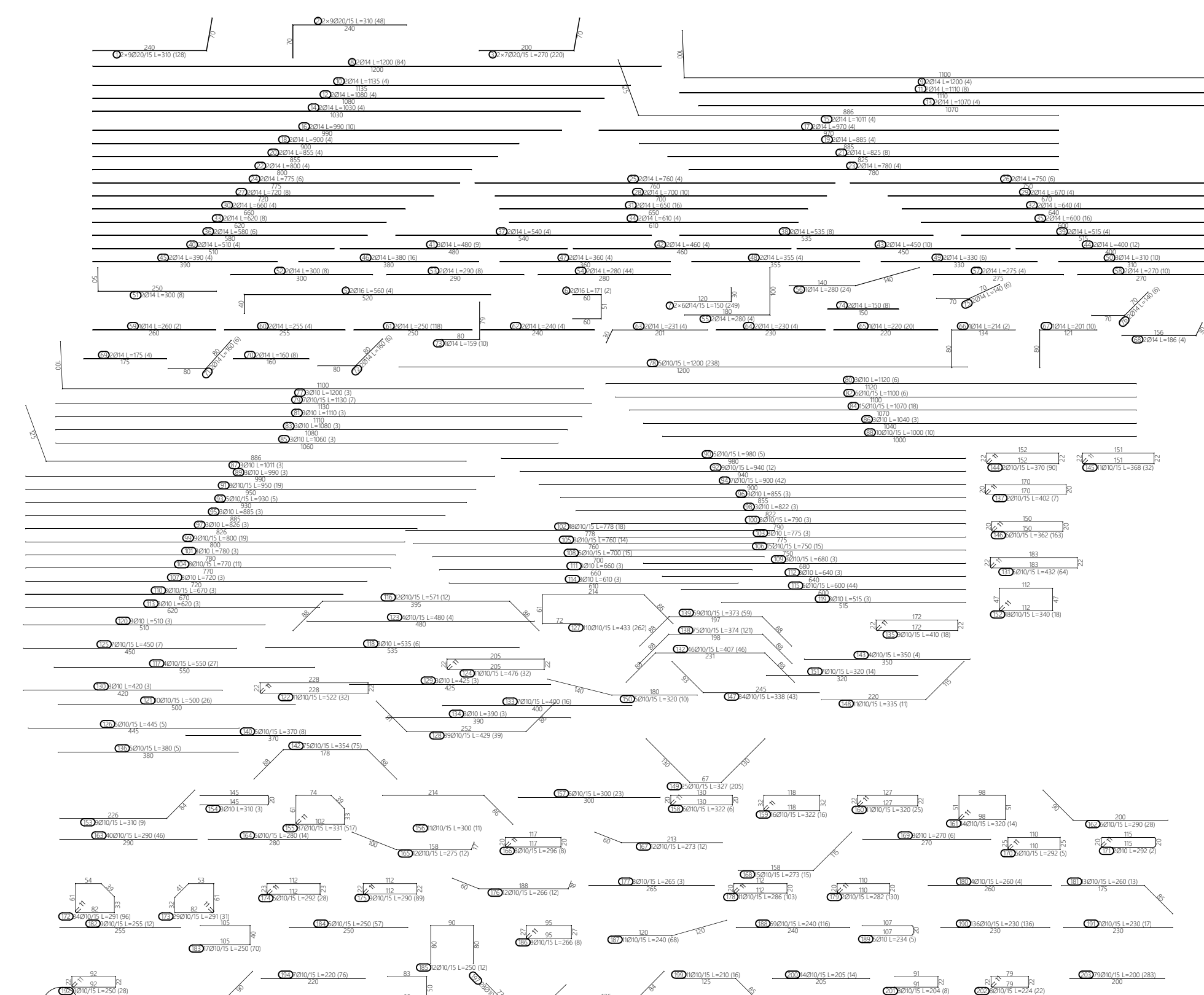
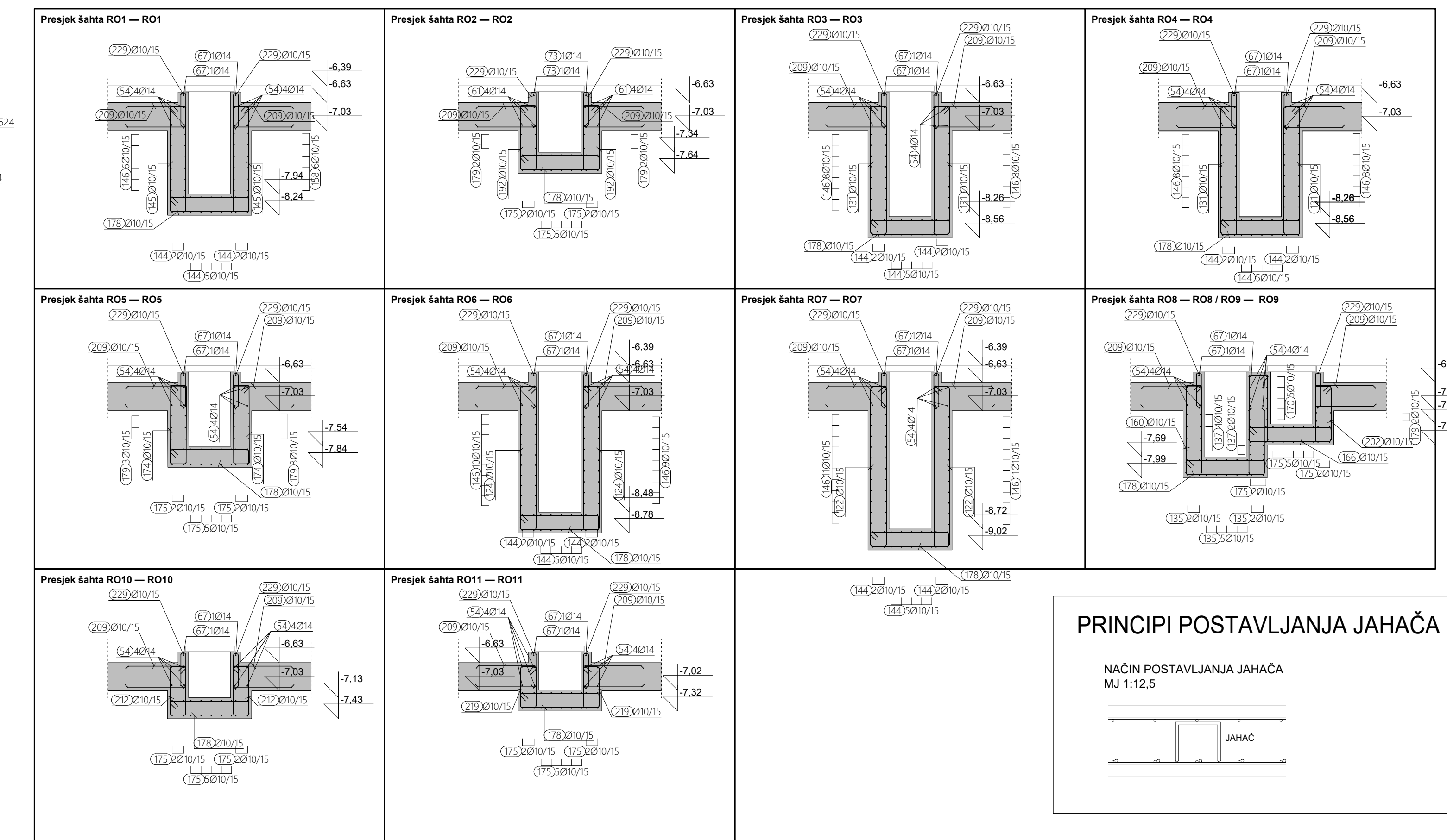
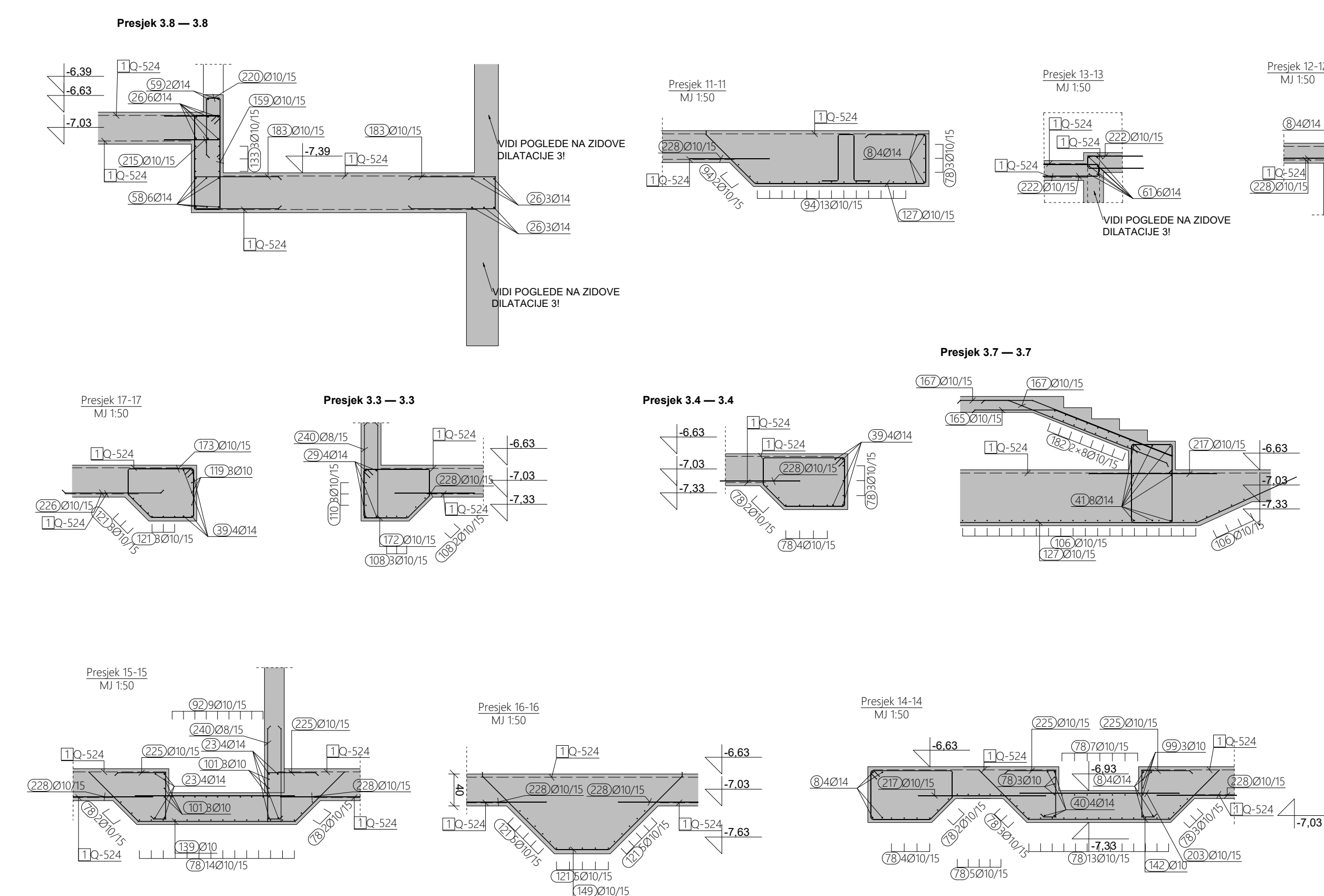

- JAHAČI - 2 KOM / m²
PLOČA d=40 cm
- JAHAČI - 2 KOM / m²
PLOČA d=50 cm
- JAHAČI - 2 KOM / m²
PLOČA d=70 cm
- JAHAČI - 2 KOM / m²
PLOČA d=25 cm

NAPOMENA
Šipke prilagoditi i po potrebi rezati na licu mjesta. Preklop 500.

NAPOMENA
Sve dimenzije provjeriti prema važećim planovima oplata.

Klasa betona	C 25/30		
Armatura	B 500 B		
Zaštitni sloj betona			
doje	gore	bočno	Pripadajući sloj armature
4,0 cm	4,0 cm	4,0 cm	ARM_TK-2_301-308_ISKAZ
Pripadajući armaturni nacrti			
ARM_TK-2_302			
ARM_TK-2_303			
ARM_TK-2_304			
ARM_TK-2_305			
ARM_TK-2_306			
ARM_TK-2_307			
ARM_TK-2_308			

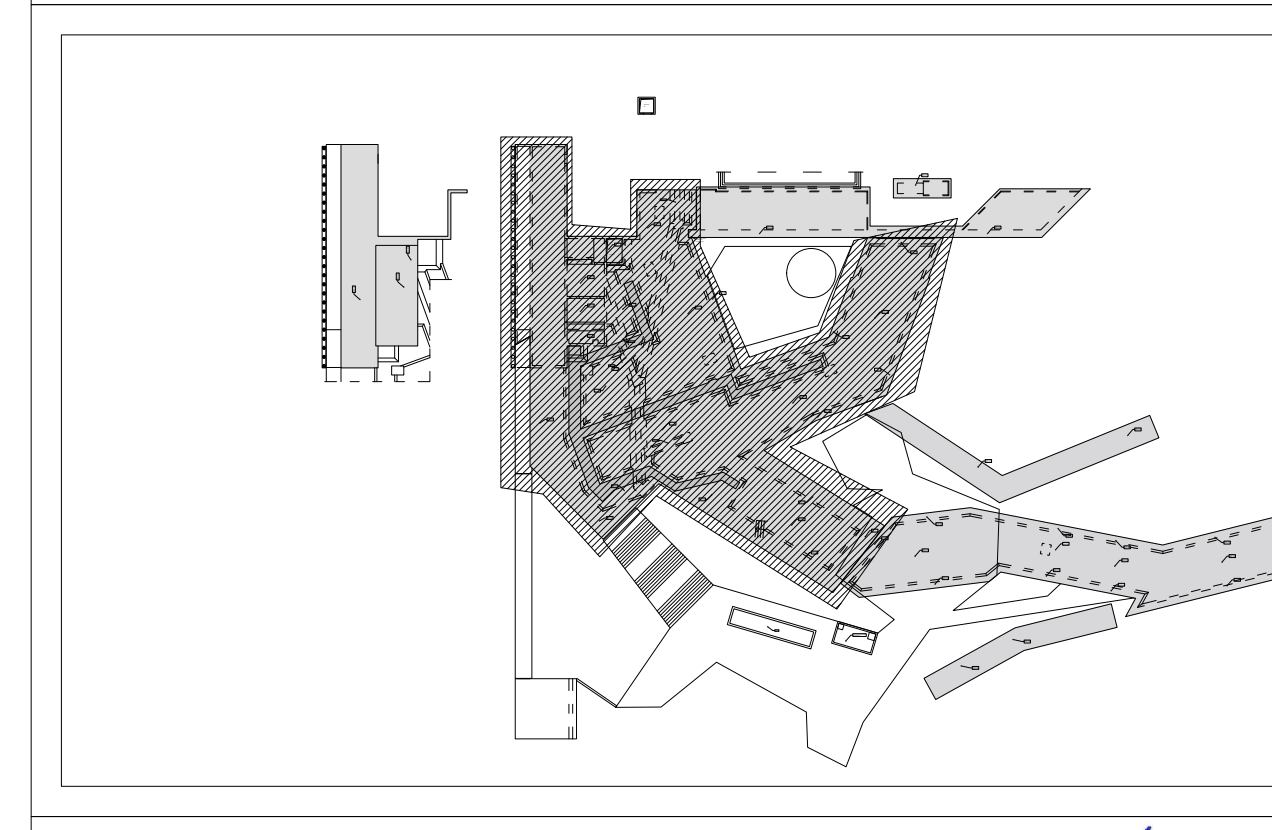

KONSTRUKTA PEČAT I POTPIŠ

KONSTRUKTA d.o.o., za projektiranje i nadzor
Dionica 09, ZAGREB, OIB: 984742695
ŽR: PRIVREDNA BANKA 2340009-110164468
TEL: 01126 43 828; FAX: 01126 43 829
MAIL: info@konstrakta.hr

INVESTITOR: TERME TUHEL d.o.o. Ujveljva Gaja 4, Tužljava Toplica, 49215 Tužljava

GRADIVNA: INŽENJERSKO PROJEKCIJSKO INŽENJERSKO DROSTROVA CENTRA TERME TUHELJE

LOKACIJA: na k.č.br. 3199/1, k.o. Orešnjevec

FAZA: IZVEDBENI PROJEKT - ARMATURNI NACRTI

SADRŽAJ: ELEMENT - DILATACIJA 3 ARMATURA TEMELJNE KONSTRUKCIJE DONJA ZONA 1/2

GL. PROJEKTANT: Tomislav Vreć, dipl. ing. arh.

PROJEKT. UV. PR. ZNADRO: Antono Maglov, dipl. ing. grad.

DATUM: 14.04.2023

MJERILO: 1:50; 1:25; REVIDIJA: 00

NACRT BR.: ARM - TK-2 - 301

**NACRT SAVIJANJA ARMATURE TEMELJA TK-2
DILATACIJA 3
ARMATURA DONJE ZONE 2/2, M 1:50**

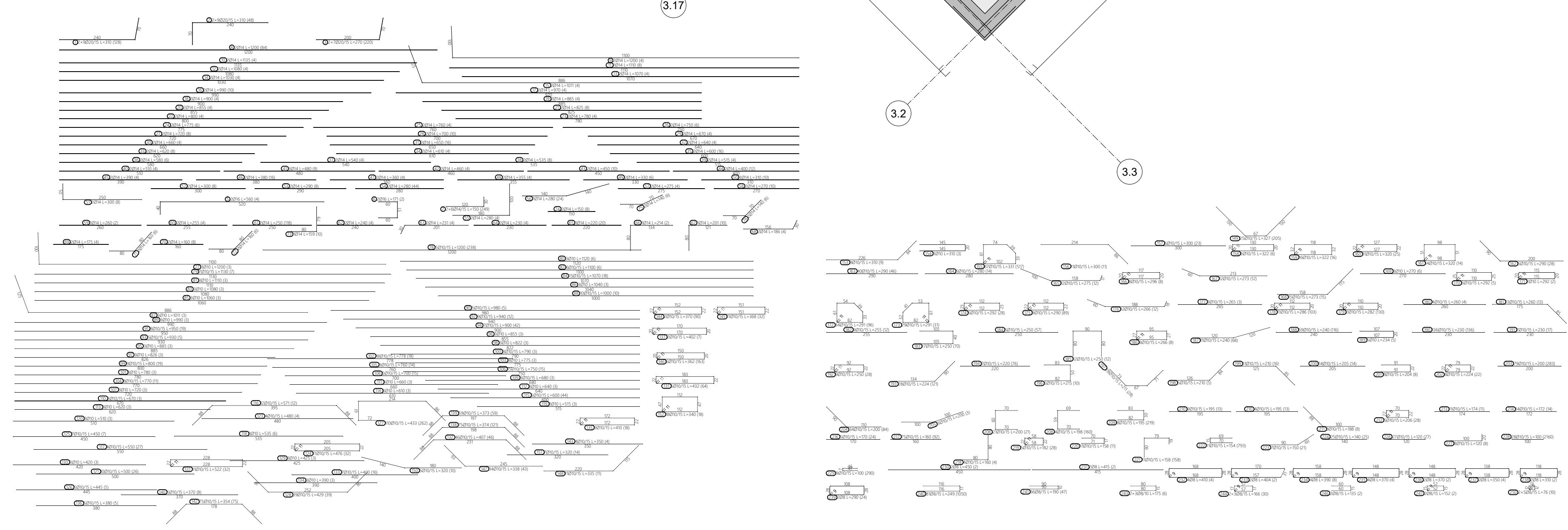
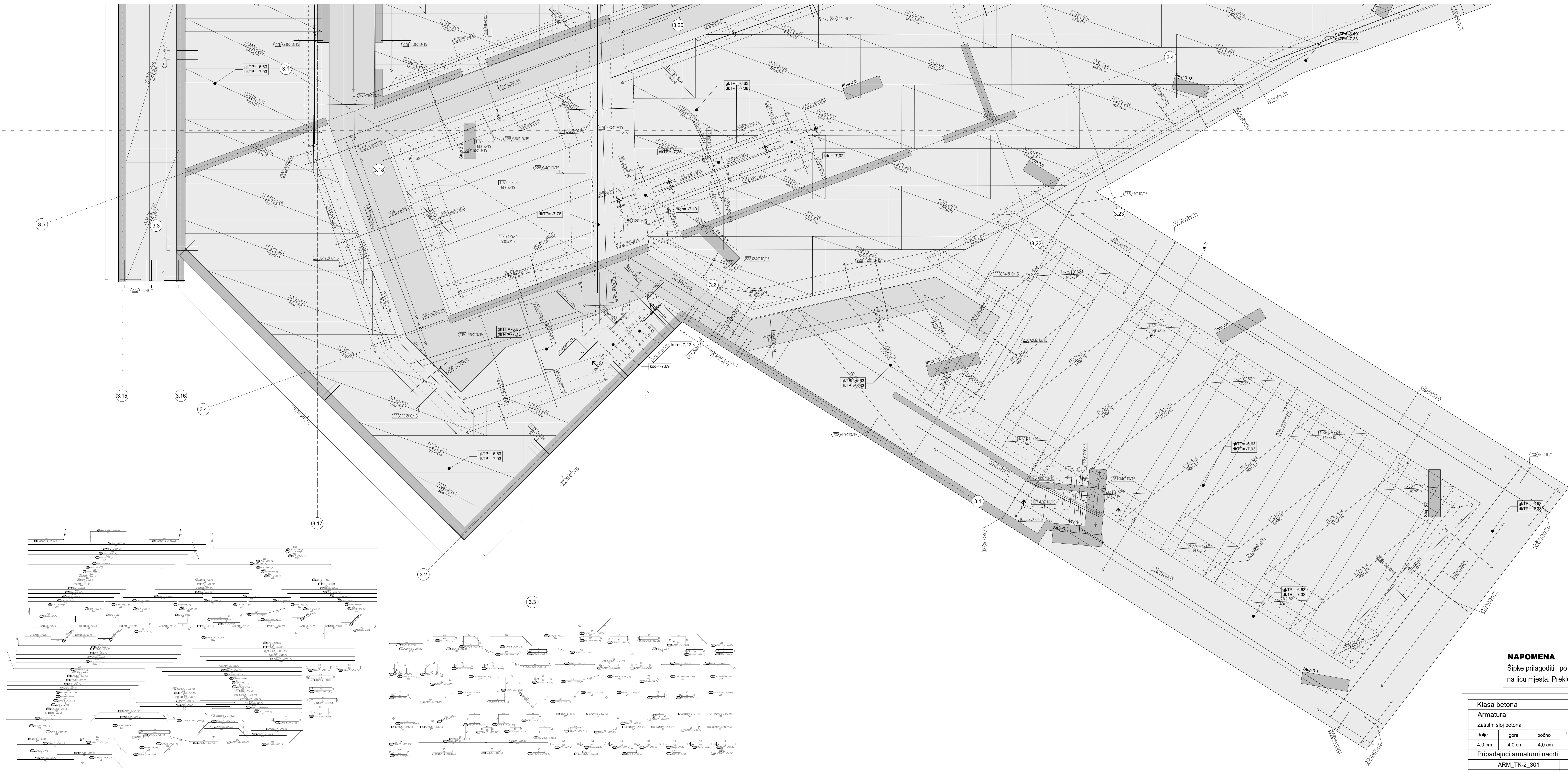

NAPOMENA
Šipke prilagođi i po potrebi rezi na licu mjesta. Preklap 500.

NAPOMENA
Sve dimenzije provjeriti prema važećim planovima oplata.

Klasa betona	C 25/30		
Armatura	B 500 B		
Zaštitni sloj betona	Pripadajući sloj armature		
dole	gore	bočno	ARM_TK-2_301_ISKAZ
4,0 cm	4,0 cm	4,0 cm	
Pripadajući armaturni nacrti			
ARM_TK-2_301			
ARM_TK-2_303			
ARM_TK-2_304			
ARM_TK-2_305			
ARM_TK-2_306			
ARM_TK-2_308			
ARM_TK-2_308			

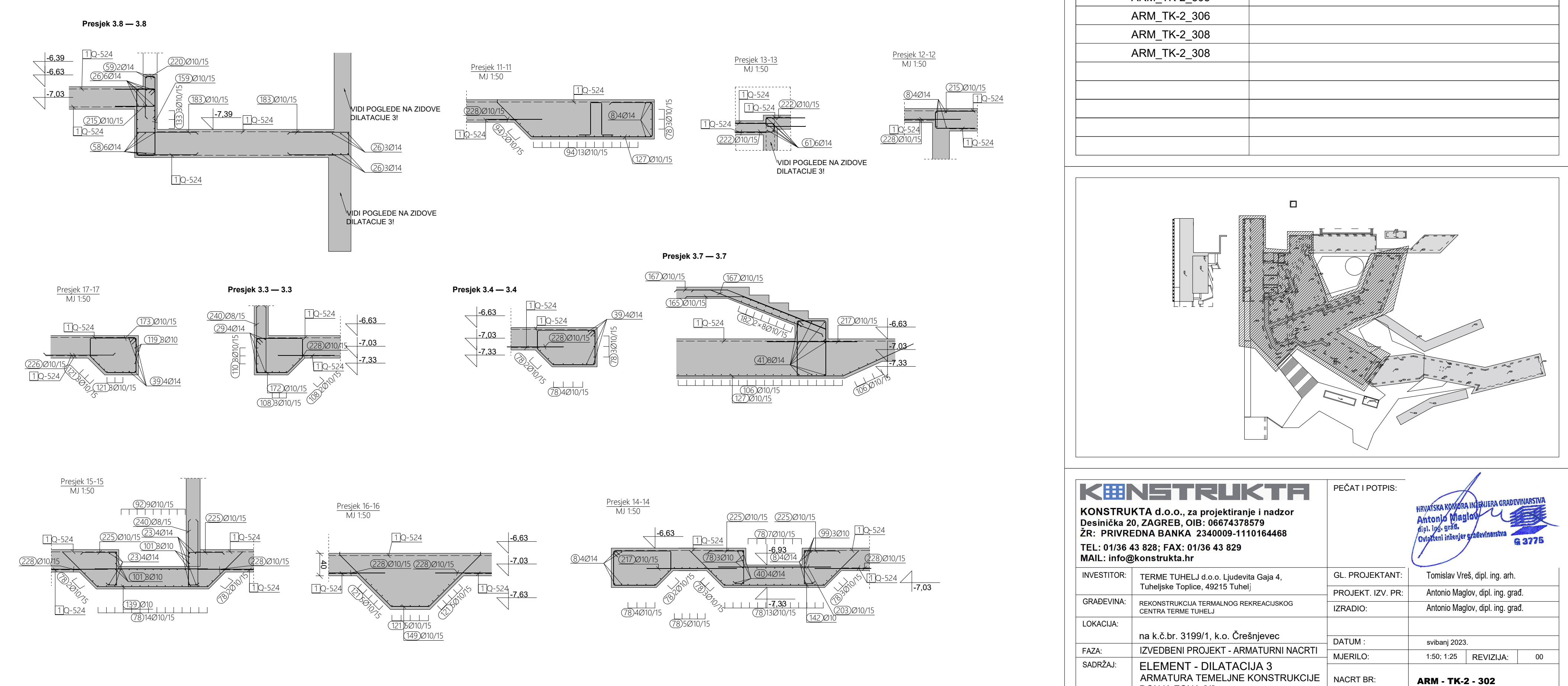
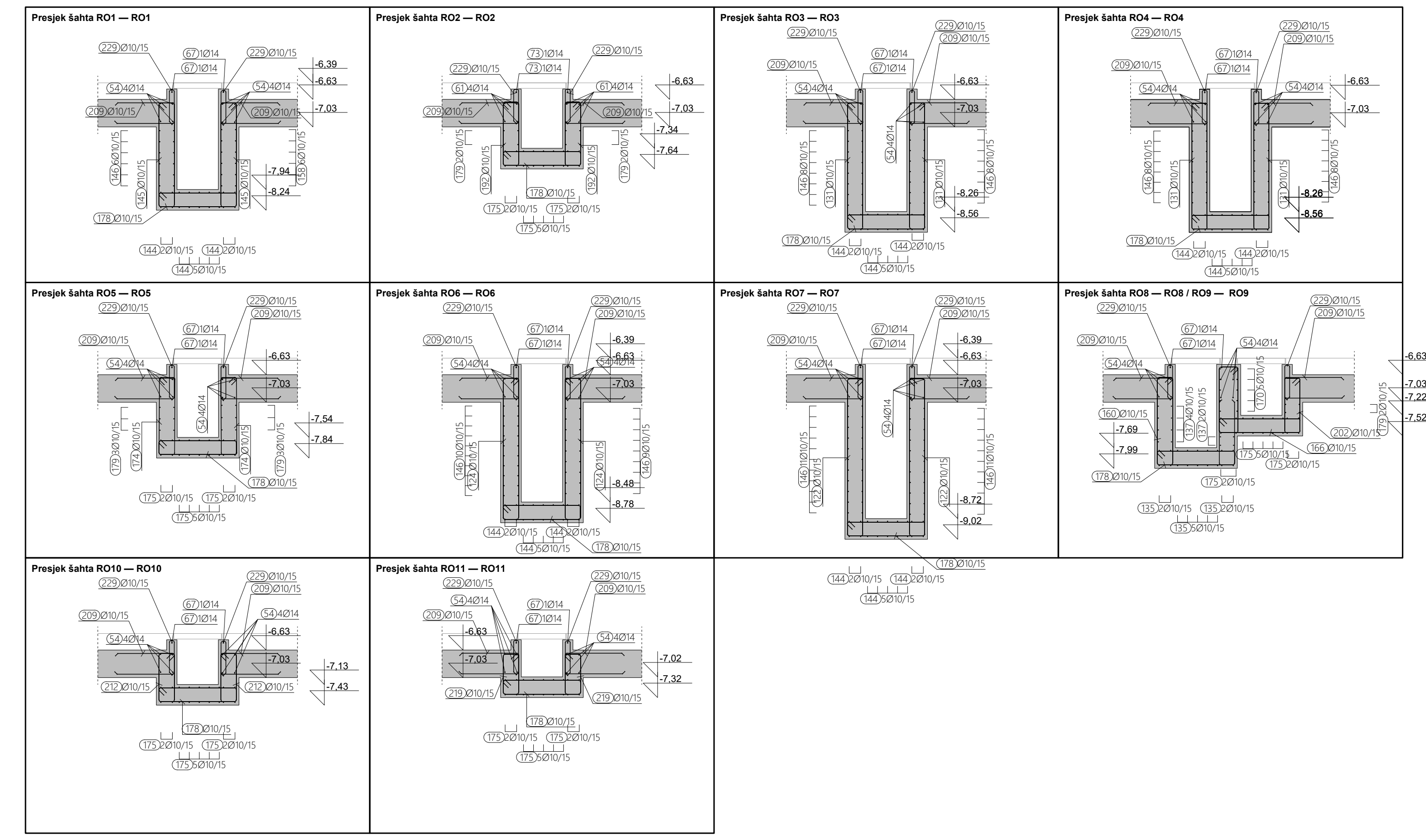

KONSTRUKTA PEČAT I POTPIŠ

KONSTRUKTA d.o.o., za projektiranje i nadzor
Desarićeva 20, ZAGREB, OIB: 0667437879
ZR: PRIVREDNA BANKA 2340009-1110164468
TEL: 01138 43 838; FAX: 01138 43 829
MAIL: info@konstrakta.hr

INVESTITOR: TERME TUNJEVI d.o.o. Ljudevita Glava 4, Tunjevske Toplice, 48215 Tunj
GRAĐEVINA: REKONSTRUKCIJA TERMANIANSKIH REKREACIJSKIH CENTARA TERME TUNJEVI
LOKACIJA: na k.o.br.: 3199/1, k.o. Črešnjevec
FAZA: IZVEDBENI PROJEKT - ARMATURNI NACRTI
SADRŽAJ: ELEMENT - DILATACIJA 3 ARMATURA TEMELJNE KONSTRUKCIJE DONJA ZONA 2/2

GL. PROJEKTANT: Tomislav Viteš, dipl. ing. arh.
PROJEKT. IZV. PR.: Antonio Maglov, dipl. ing. građ.
IZRAĐIO: Antonio Maglov, dipl. ing. građ.
DATUM: svibanj 2023.
MJESECI: 1.50.1.25
REVIZIJA: 00
NACRT BR.: **ARM - TK-2 - 302**

www.konstrakta.hr
Autorski prava
Arhitektonski biro
01375

**NACRT SAVIJANJA ARMATURE TEMELJA TK-2
DILATACIJA 3
ARMATURA GORNJE ZONE 1/2, M 1:50**

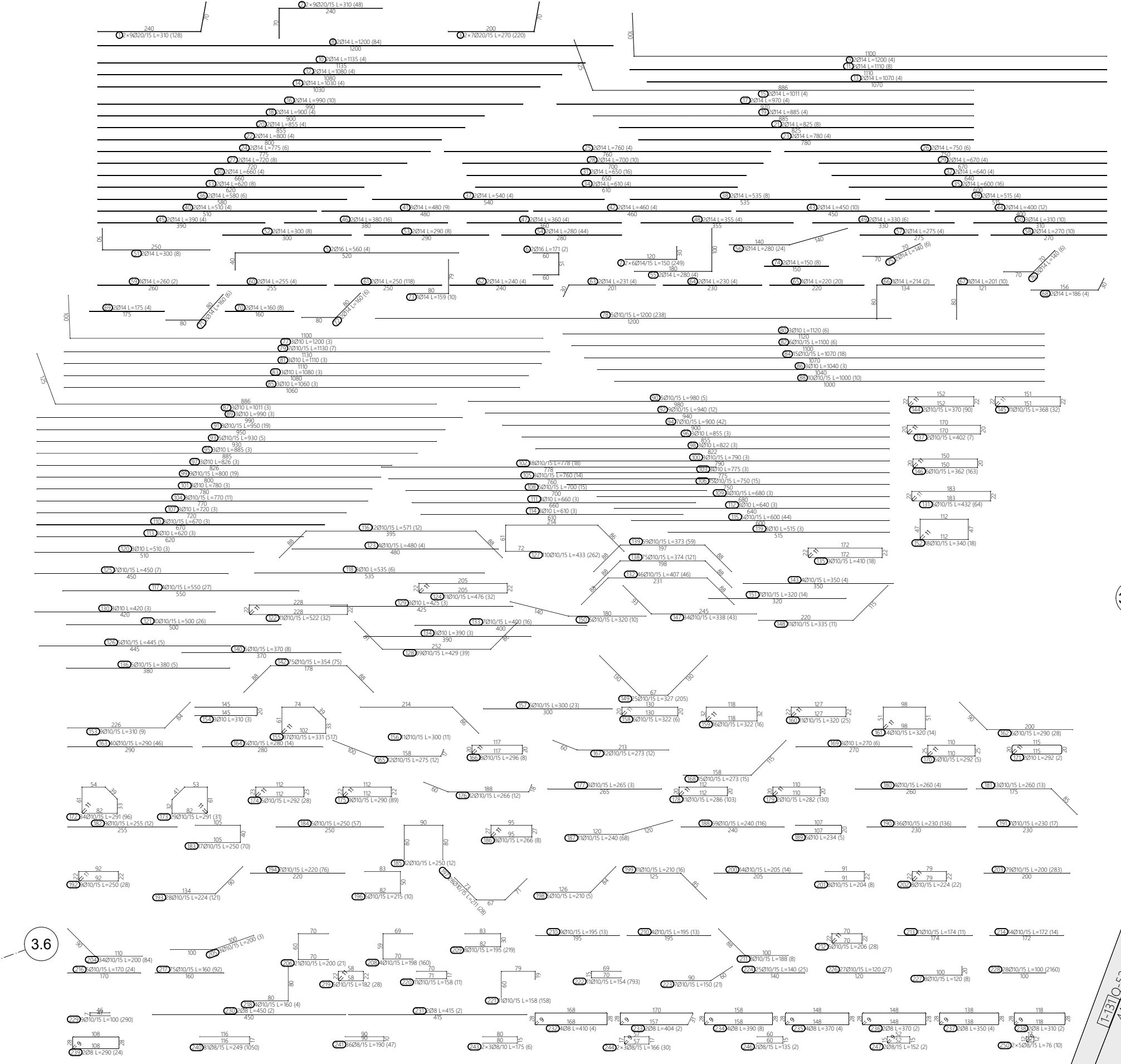
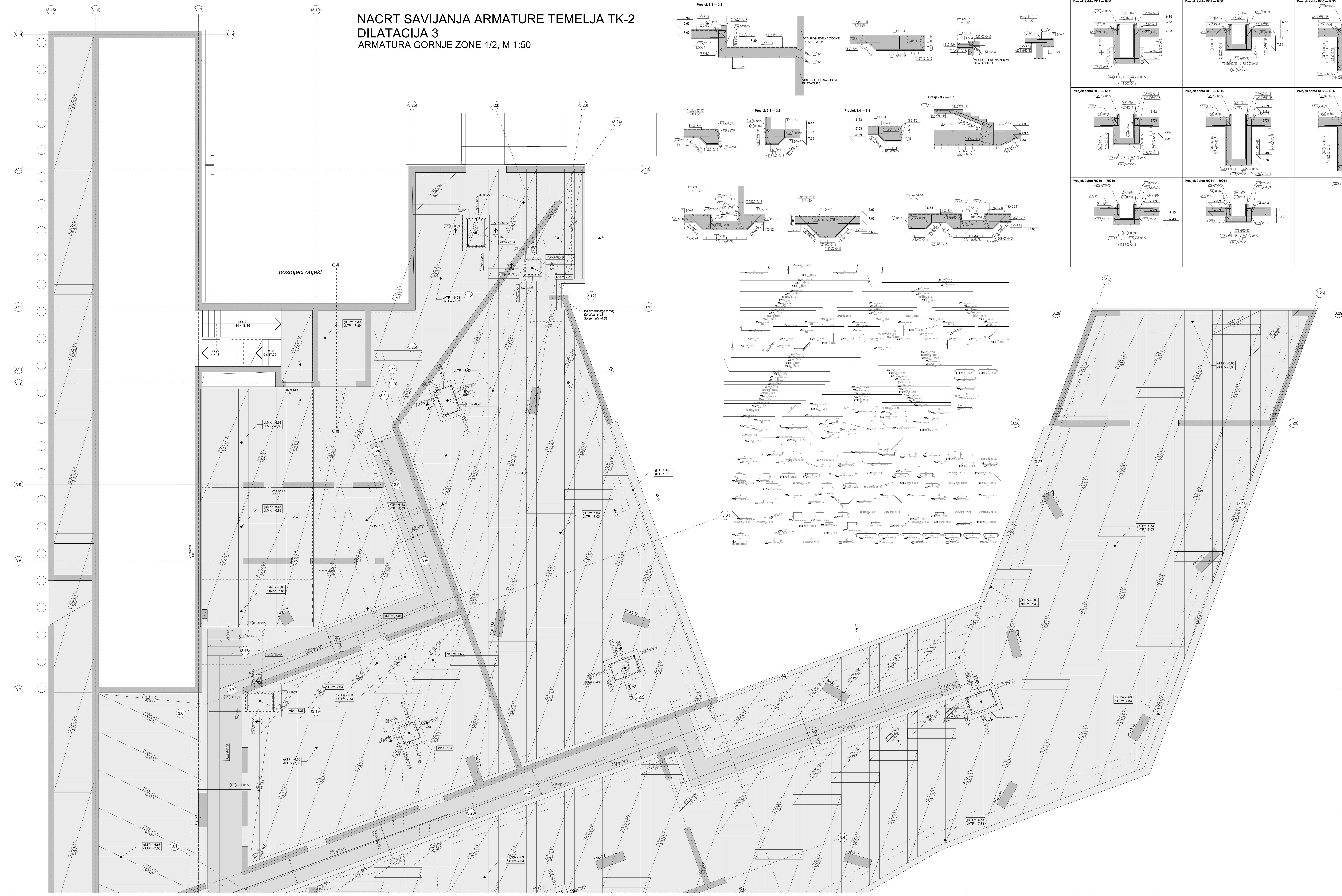
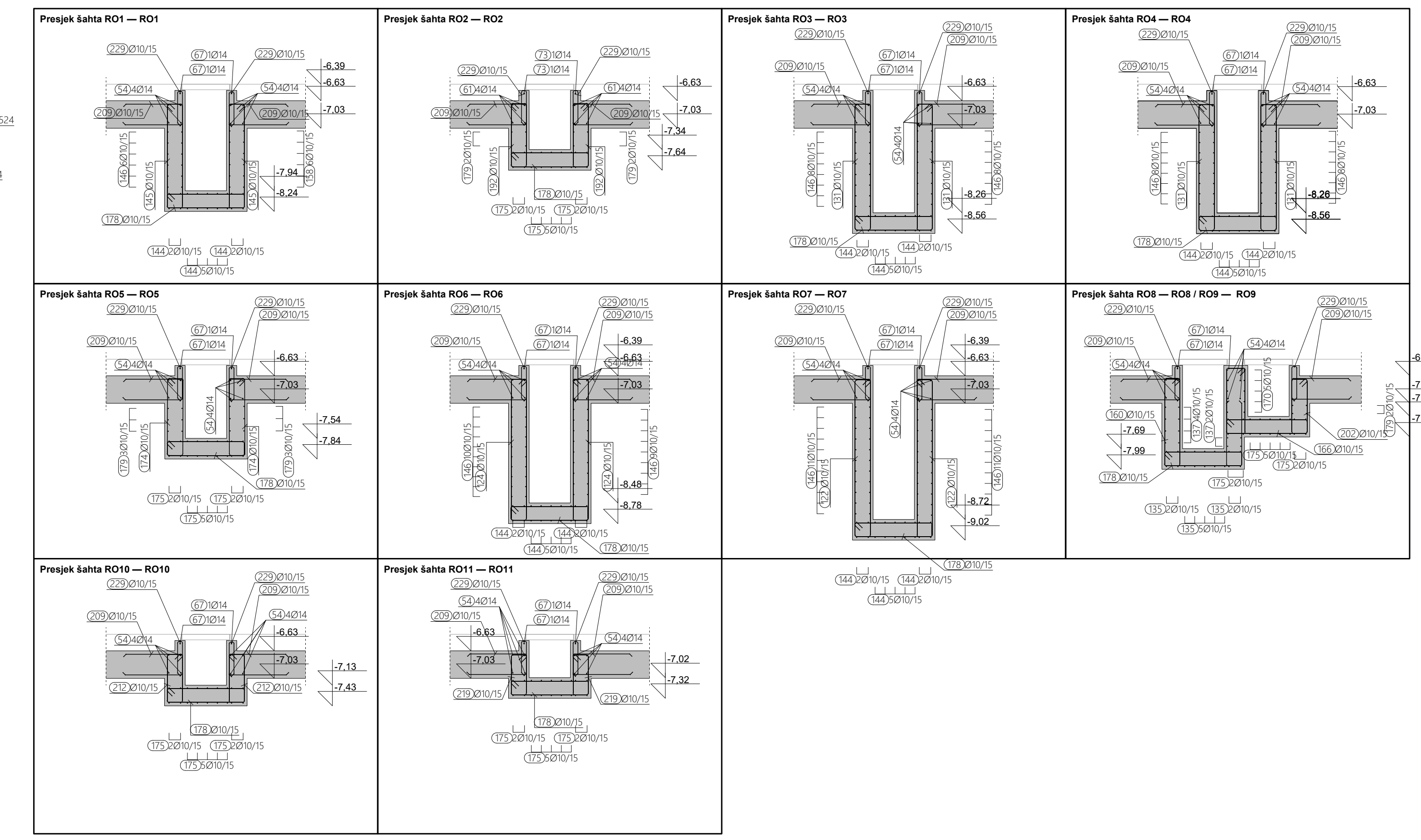
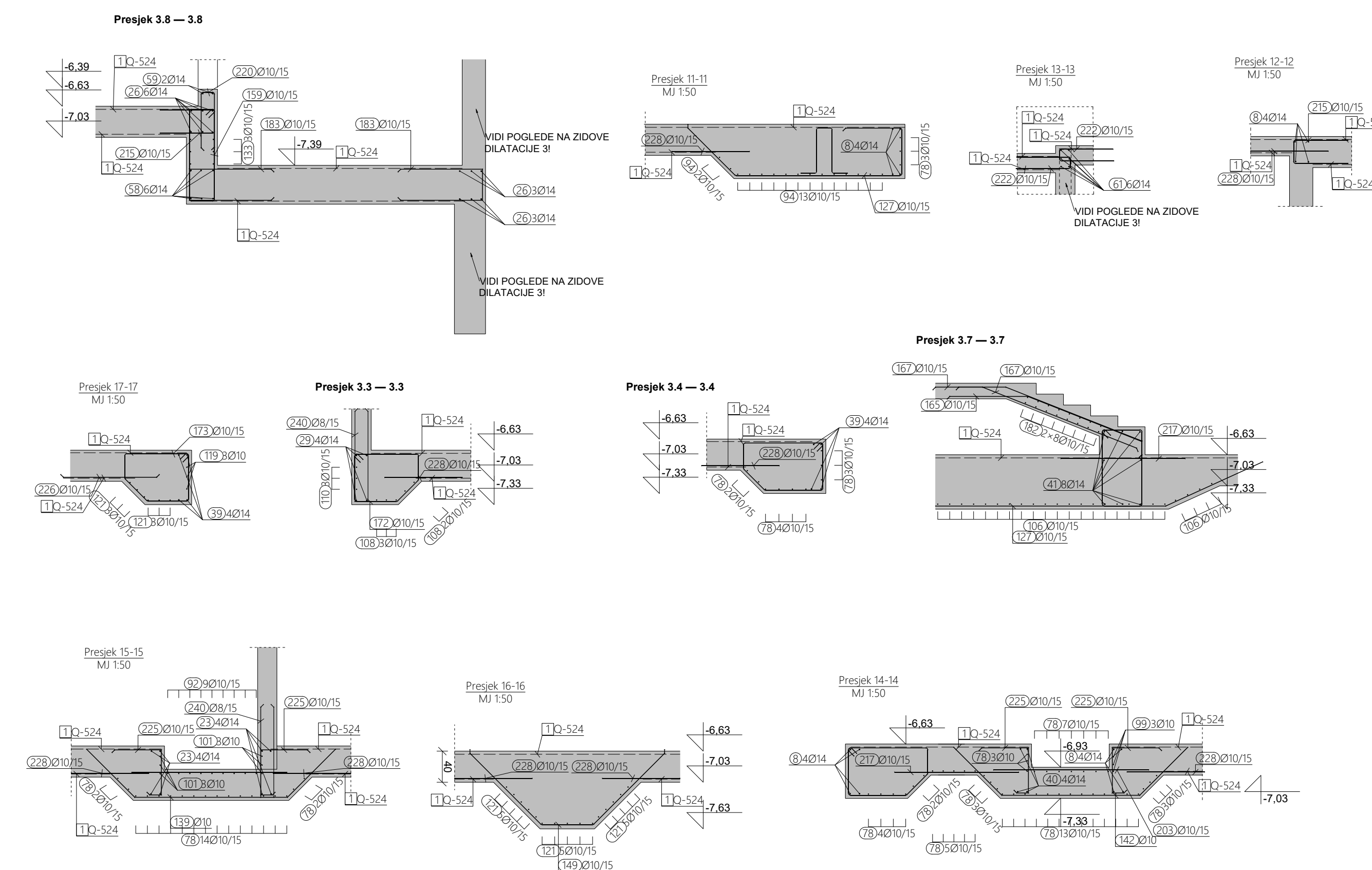

NAPOMENA
Šipke prilagoditi i po potrebi rezati na licu mjesta. Preklap 500.

NAPOMENA
Sve dimenzije provjeriti prema važećim planovima opilate.

Klasa betona	C 25/30		
Armatura	B 500 B		
Zaštitni sloj betona			
doje	gore	bočno	Pripadajući islo armature: ARM_TK-2_301-308_ISKAZ
4,0 cm	4,0 cm	4,0 cm	
Pripadajući armaturni nacrti			
ARM_TK-2_301			
ARM_TK-2_302			
ARM_TK-2_304			
ARM_TK-2_305			
ARM_TK-2_306			
ARM_TK-2_308			
ARM_TK-2_308			

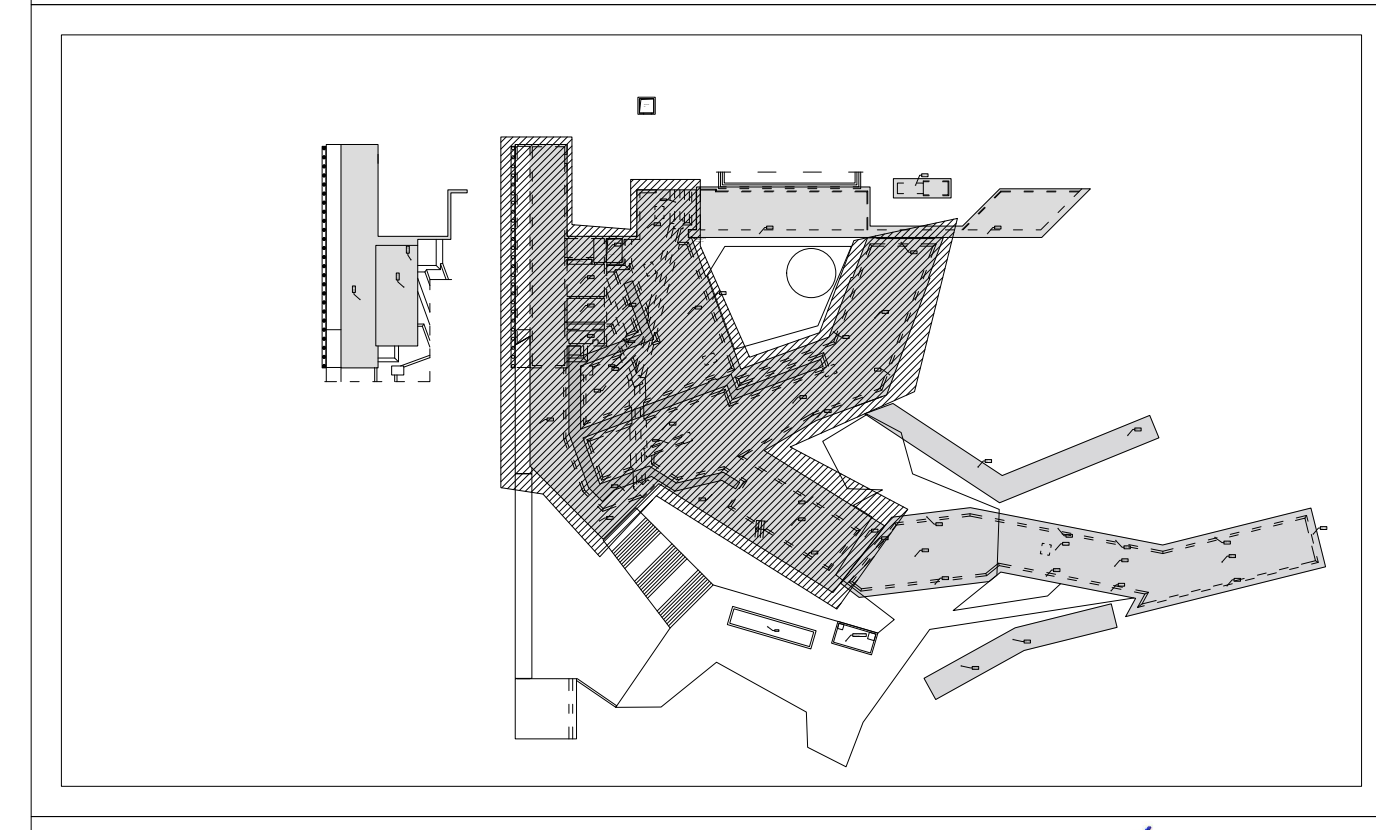

KONSTRUKTA PEČAT I POTPIŠ
KONSTRUKTA d.o.o. za projektiranje i nadzor
 Dječanska 29, ZAGREB, OIB: 664743769
 ŽR: PRIVREDNA BANKA 2340009-110164468
 TEL: 0126 43 828; FAX: 0126 43 829
 MAIL: info@konstrakta.hr

INVESTITOR: TERME TUHEL d.o.o. Ljudevita Gaja 4, Tužlana Toplica, 49215 Tužlana
GRADIVNA: INŽENJERSKO PROJEKCIJSKO INŽENJERSKO ODJELJE CENTRA TERME TUHEL
LOKACIJA: na k.č.br. 3199/1, k.o. Oresnjevec
FAZA: IZVEDBENI PROJEKT - ARMATURNI NACRTI
SADRŽAJ: ELEMENT - DILATACIJA 3 ARMATURA TEMELJNE KONSTRUKCIJE GORNJA ZONA 1/2

GL. PROJEKTANT: Tomislav Vreć, dipl. ing. arh.
PROJEKT. UV. PR.: Antonio Maglov, dipl. ing. grad.
ODRADIO: Antonio Maglov, dipl. ing. grad.
ODJELJE: inžinjering
MIJERILO: 1:50; 1:25; REVIZIJA: 00
NACRT. BR.: ARM - TK-2 - 303

**NACRT SAVIJANJA ARMATURE TEMELJA TK-2
DILATACIJA 3
ARMATURA GORNJE ZONE 2/2, M 1:50**

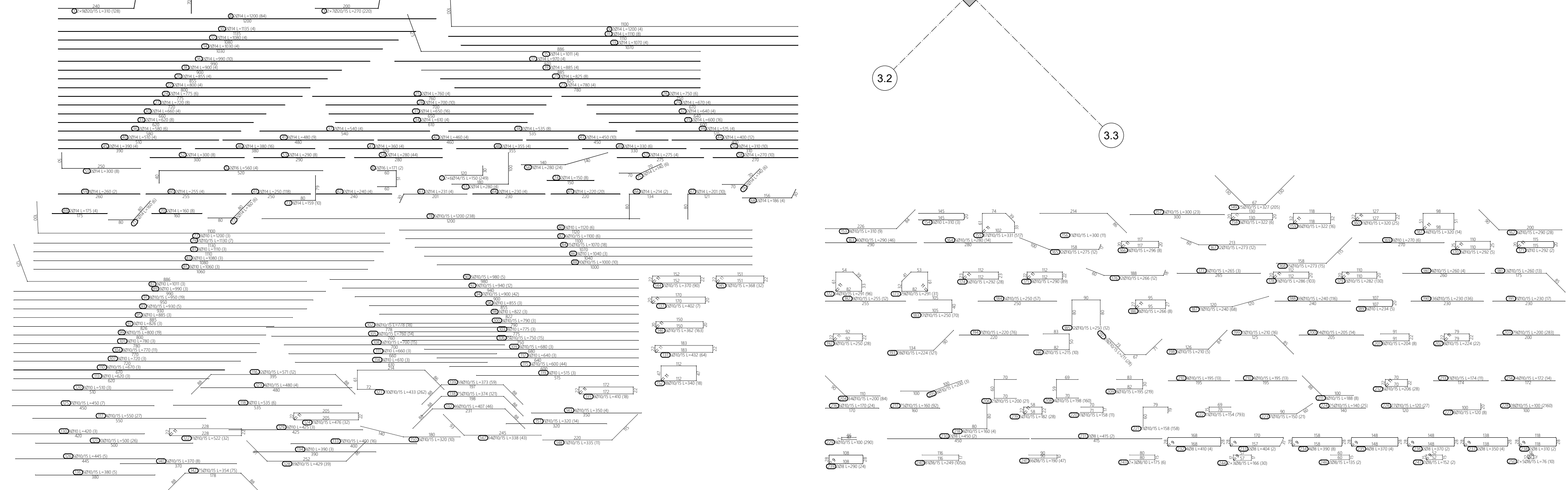
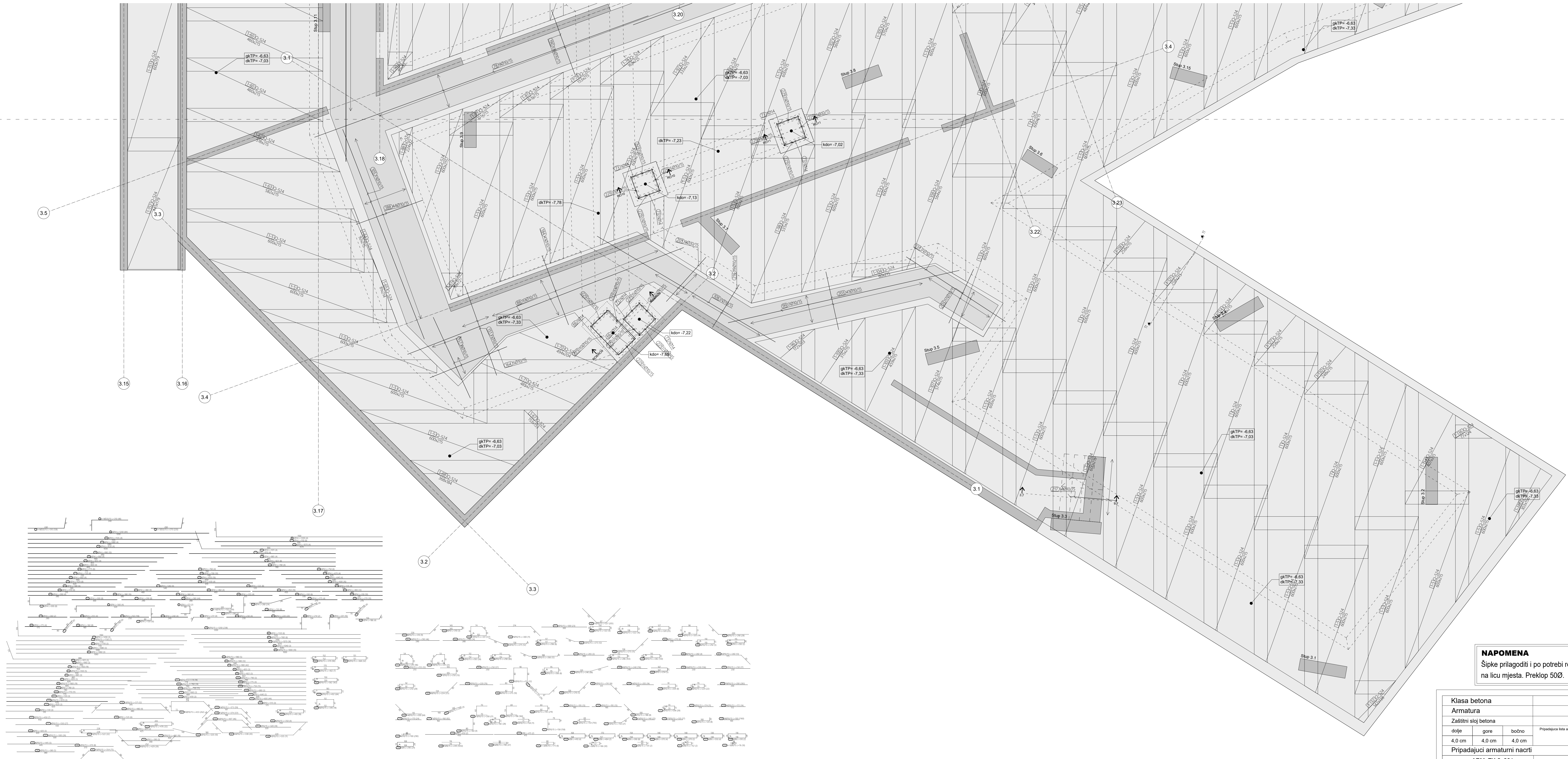

NAPOMENA
Šipke prilagoditi i po potrebi rezati na licu mjesta. Preklap 500.

NAPOMENA
Sve dimenzije provjeriti prema važećim planovima oplata.

Klasa betona	C 25/30
Armatura	B 500 B
Zaštitni sloj betona	
dole	gore
4,0 cm	4,0 cm
	bočno
	4,0 cm
Prilagodljiva šipka armature: ARM_TK-2_301-308_ISKAZ	
Prilagodljivi armaturni nacrti	
ARM_TK-2_301	
ARM_TK-2_302	
ARM_TK-2_303	
ARM_TK-2_305	
ARM_TK-2_306	
ARM_TK-2_307	
ARM_TK-2_308	

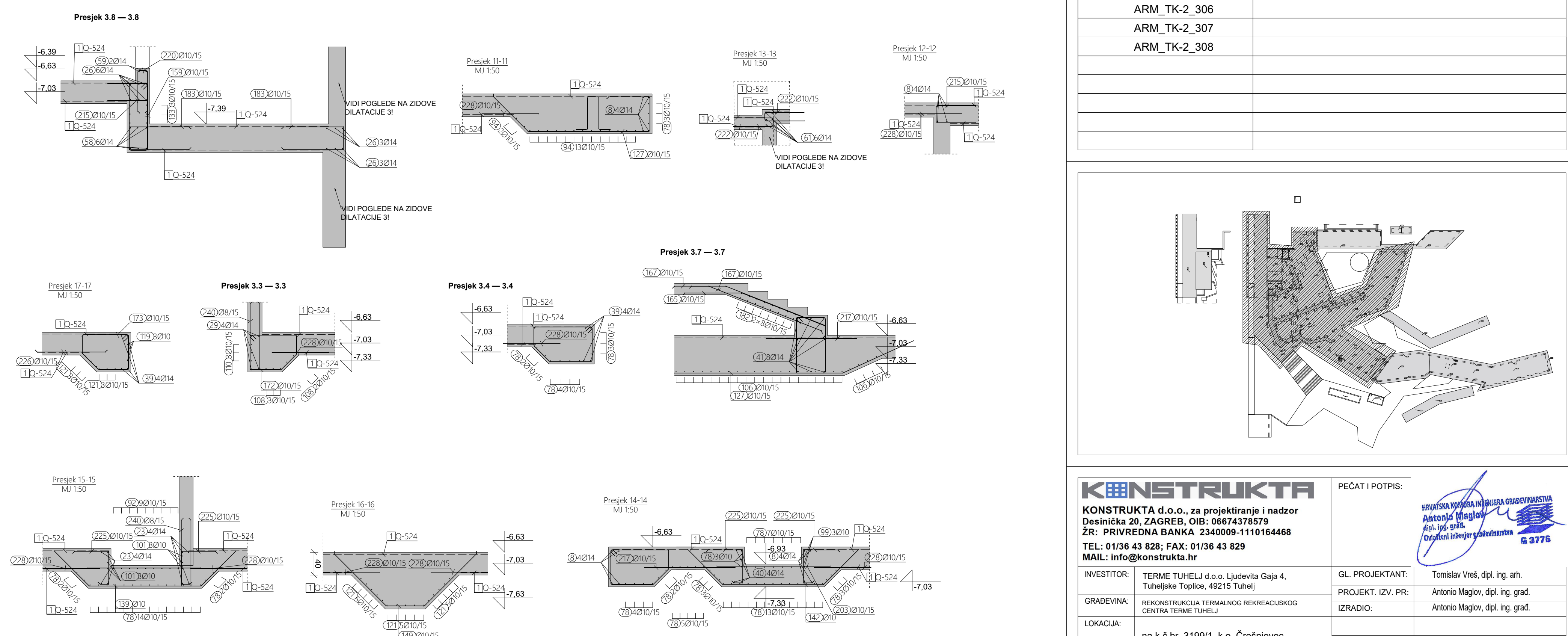
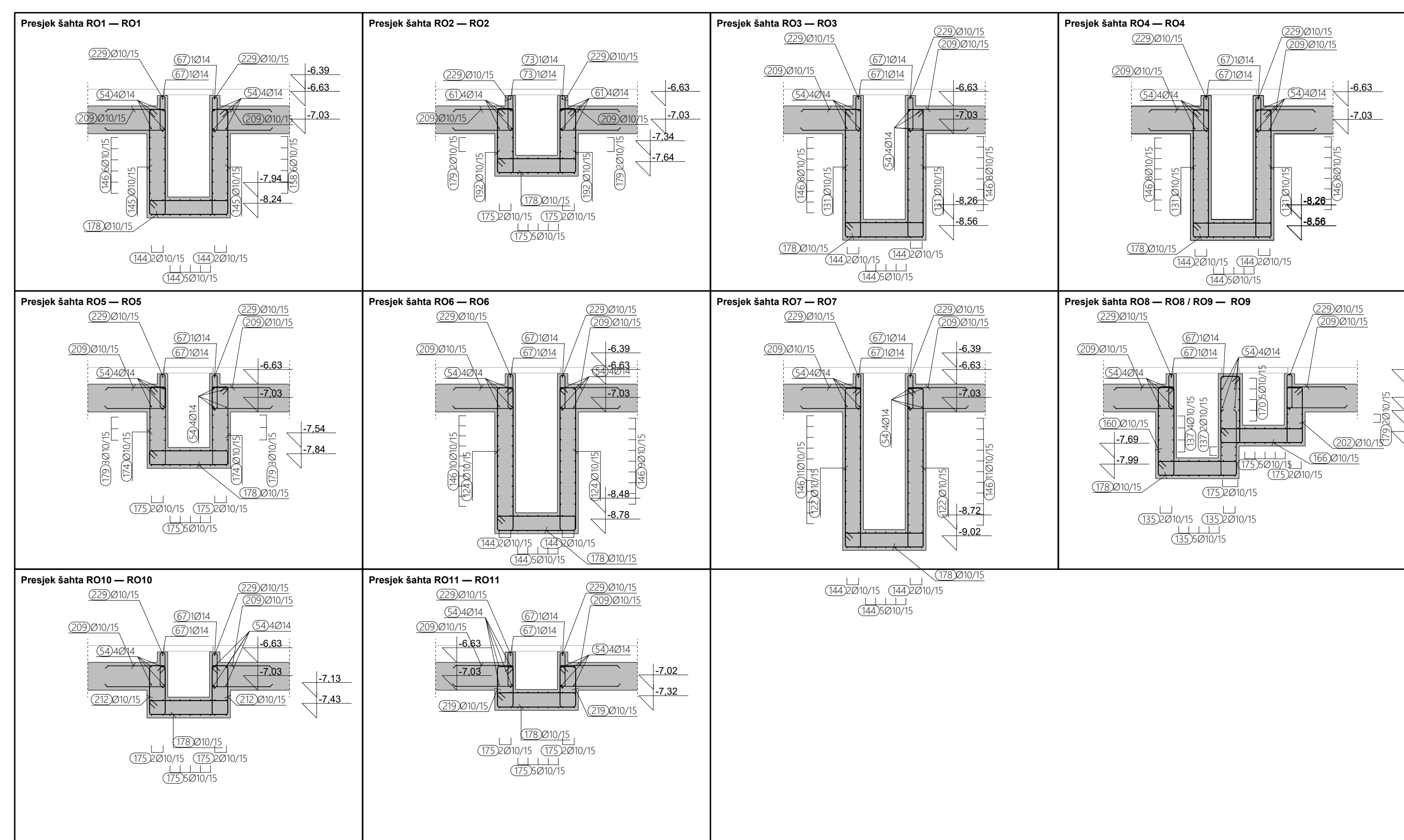

KONSTRUKTA PEČAT I POTPISE

KONSTRUKTA d.o.o., za projektiranje i nadzor
Desarićeva 21, ZAGREB, OIB: 0667437879
ZR: PRIVREDNA BANKA 2340009-110164468
TEL: 01136 43 838; FAX: 01136 43 829
MAIL: info@konstrukt.hr

INVESTITOR: TERME TUNELI d.o.o. Ujovčeva Glava 4, Tuševske Toplice, 48215 Tuševci

GRAĐEVINA: REKONSTRUKCIJA TERMANANS REKREACIJSKOG CENTRA TERME TUNELI

LOKACIJA: na k.o.br. 3199/1, k.o. Črešnjevec

FAZA: IZVEDBENI PROJEKT - ARMATURNI NACRTI

SADRŽAJ: ELEMENT - DILATACIJA 3 ARMATURA TEMELJNE KONSTRUKCIJE GORNJA ZONA 2/2

GL. PROJEKTANT: Tomislav Viteš, dipl. ing. arh.

PROJEKT. IZV. PR.: Antonio Maglov, dipl. ing. građ.

URADNIK: Antonio Maglov, dipl. ing. građ.

DATUM: svibanj 2023.

MJERILIC: 1:50, 1:25

REVIZIJA: 00

NACRT BR.: **ARM - TK-2 - 304**

**NACRT SAVIJANJA ARMATURE TEMELJA TK-2
DILATACIJA 3
RUBNA ARMATURA 1/2, M 1:50**

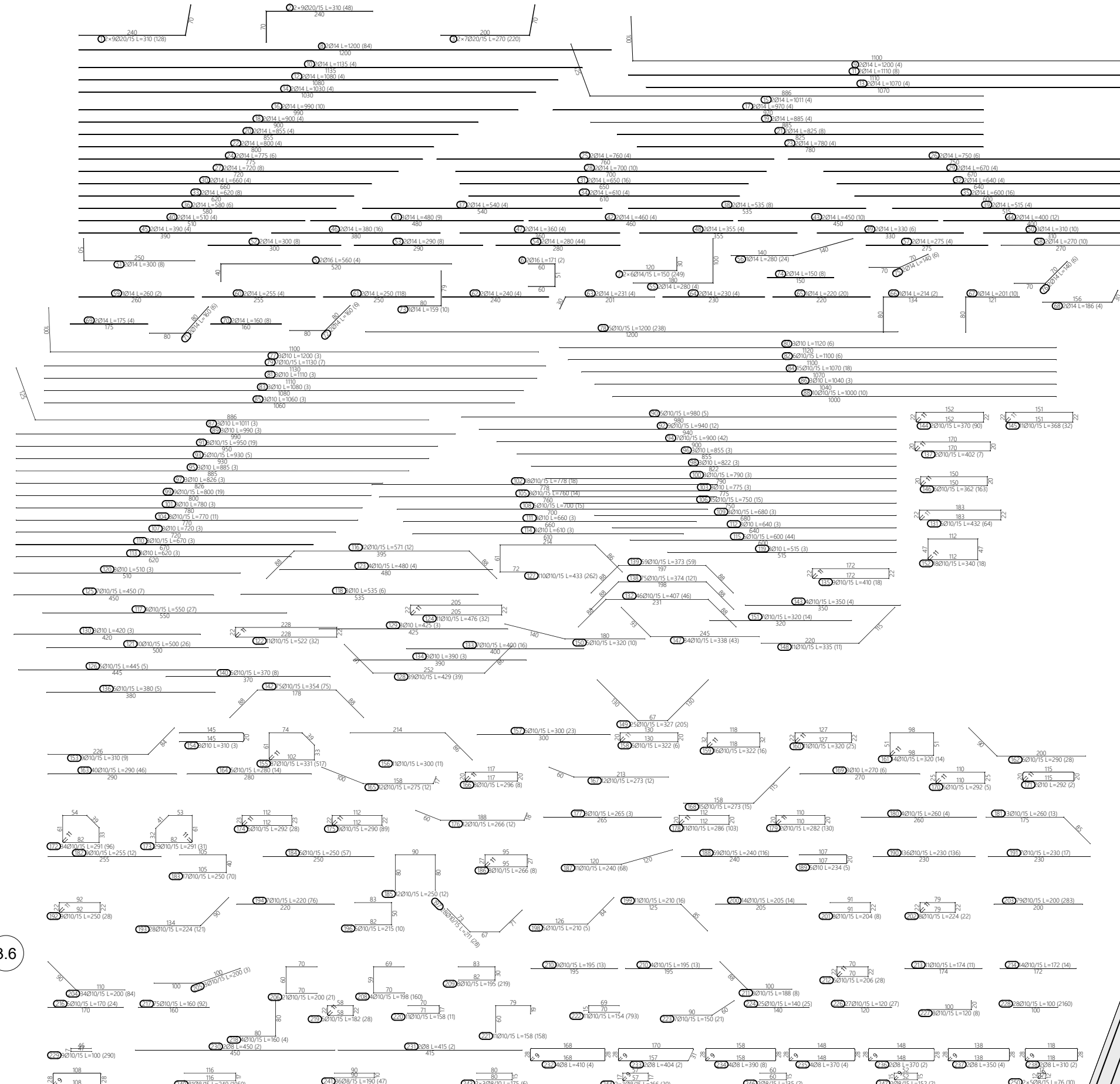
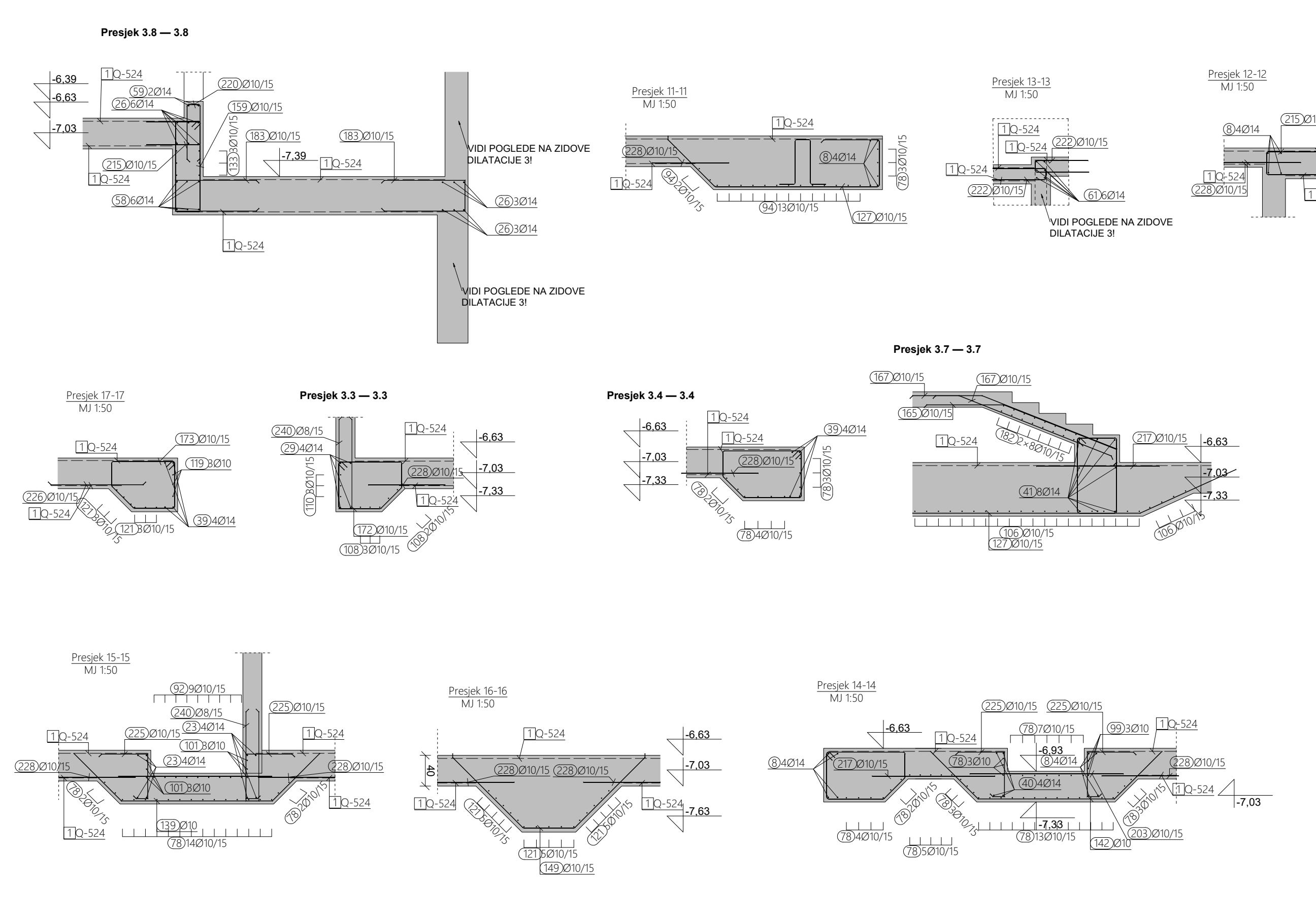
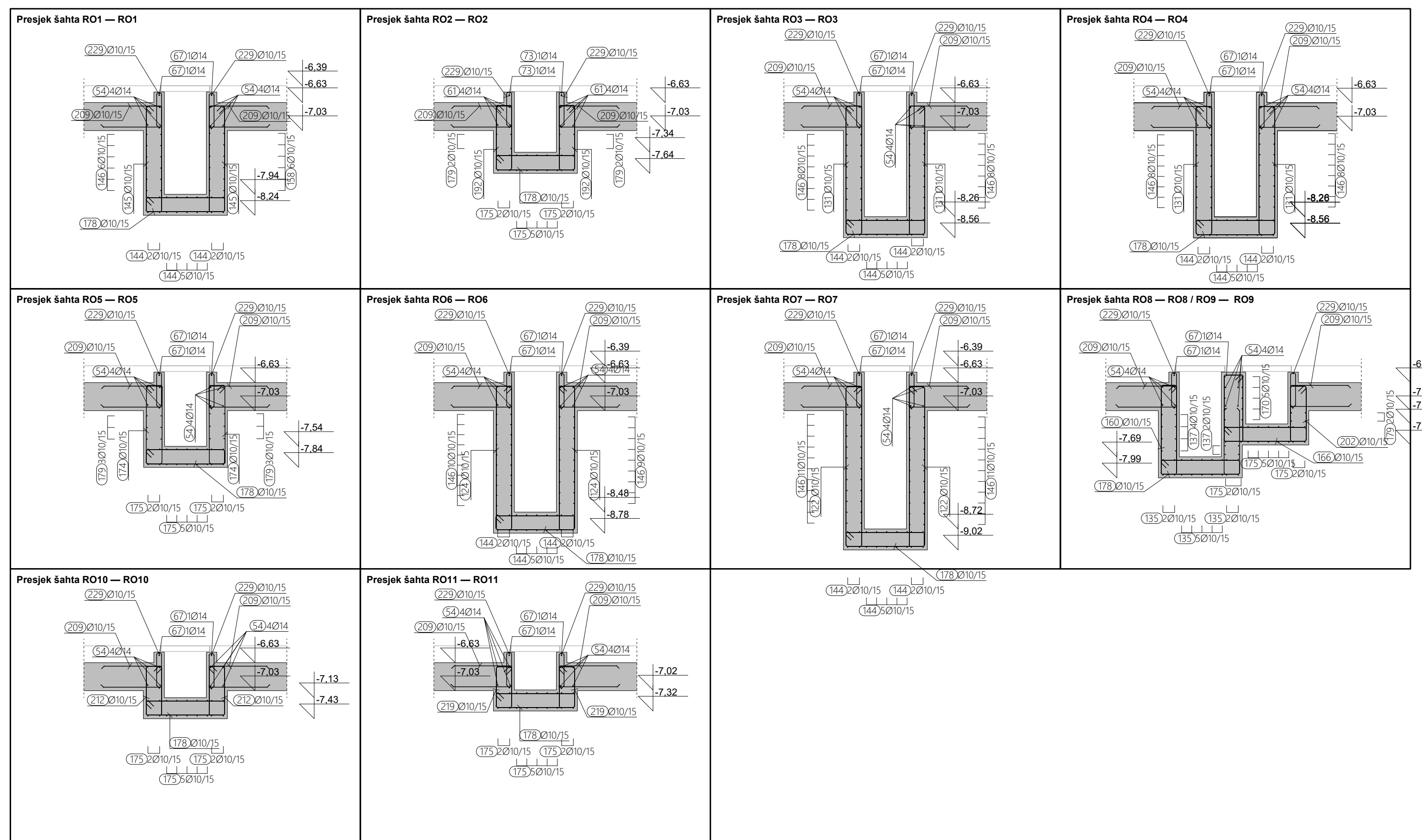


NAPOMENA
Šipke prilagoditi i po potrebi rezati na licu mjesta. Preklap 500.

NAPOMENA
Sve dimenzije provjeriti prema važećim planovima optate.

Klasa betona	C 25/30
Armatura	B 500 B
Zaštitni sloj betona	Preporučeno ispo armature
doje	gore
4,0 cm	4,0 cm
Pripadajući armaturni nacrti	
ARM_TK-2_301	
ARM_TK-2_302	
ARM_TK-2_303	
ARM_TK-2_304	
ARM_TK-2_306	
ARM_TK-2_307	
ARM_TK-2_308	

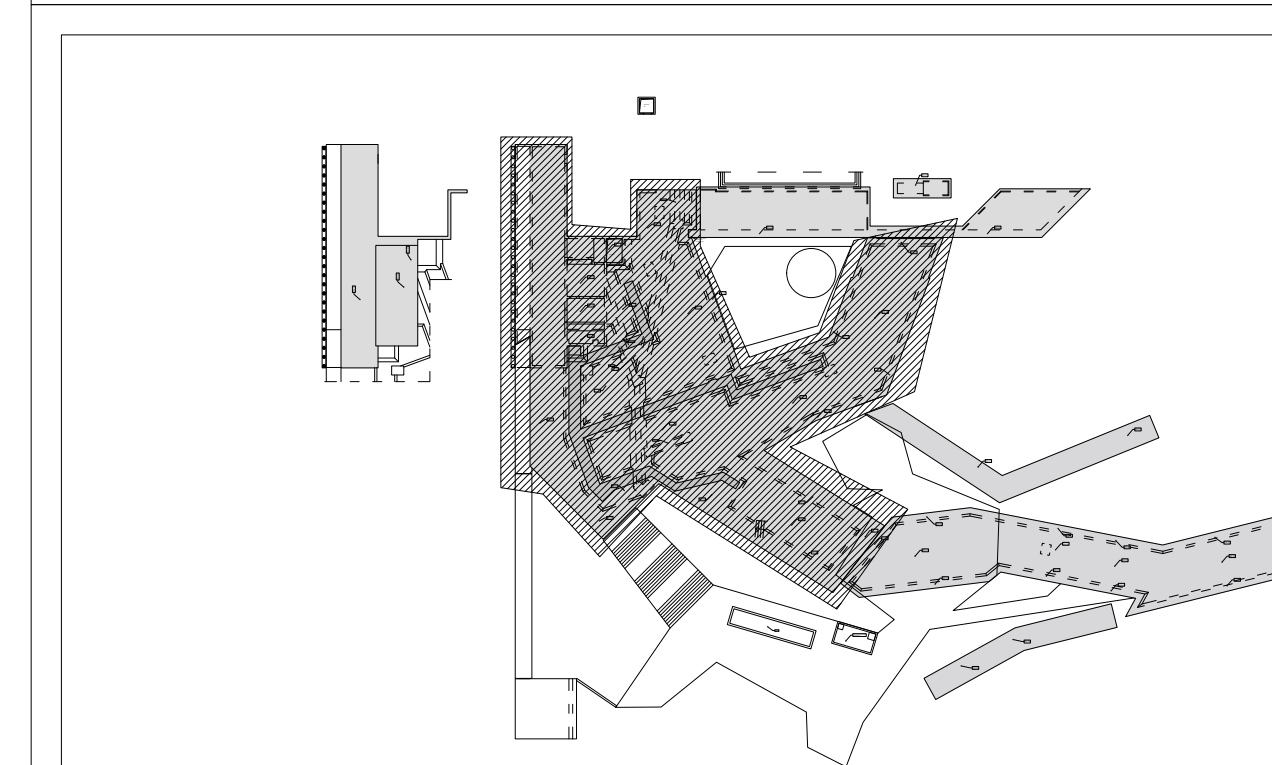

KONSTRUKTA PEČAT I POTPIŠ
 KONSTRUKTA d.o.o. za projektiranje i nadzor
 Dječanska 29, ZAGREB, OIB: 696747009
 ZR: PRIVREDNA BANKA 2340009-110164468
 TEL: 01126 43 828; FAX: 01126 43 829
 MAIL: info@konstrakta.hr

INVESTITOR: TERME TUNJEVA d.o.o. Ljudevitova Gajka 4, Tunjeva Toplica, 49215 Tunjeva
 GRAĐEVINA: REKONSTRUKCIJA TERMOBILNOG POKRETAČKOG CENTRA TERME TUNJEVA
 IZVOĐAČ: na k.č.br. 3199/1, k.o. Orešnjevec
 FAZA: IZVEDBENI PROJEKT - ARMATURNI NACRTI
 SADRŽAJ: ELEMENT - DILATACIJA 3 ARMATURA TEMELJNE KONSTRUKCIJE RUBNA ARMATURA 1/2

GL. PROJEKTANT: Tomislav Vreć, dipl. ing. arh.
 PROJEKT. UV. PR. ORADIO: Antono Maglov, dipl. ing. grad.
 DATUM: 14.04.2023
 MIERILO: 1:50; 1:25; REVIDIJA: 00
 NACRT BR.: ARM - TK-2 - 305

**NACRT SAVIJANJA ARMATURE TEMELJA TK-2
DILATACIJA 3
RUBNA ARMATURA 2/2, M 1:50**

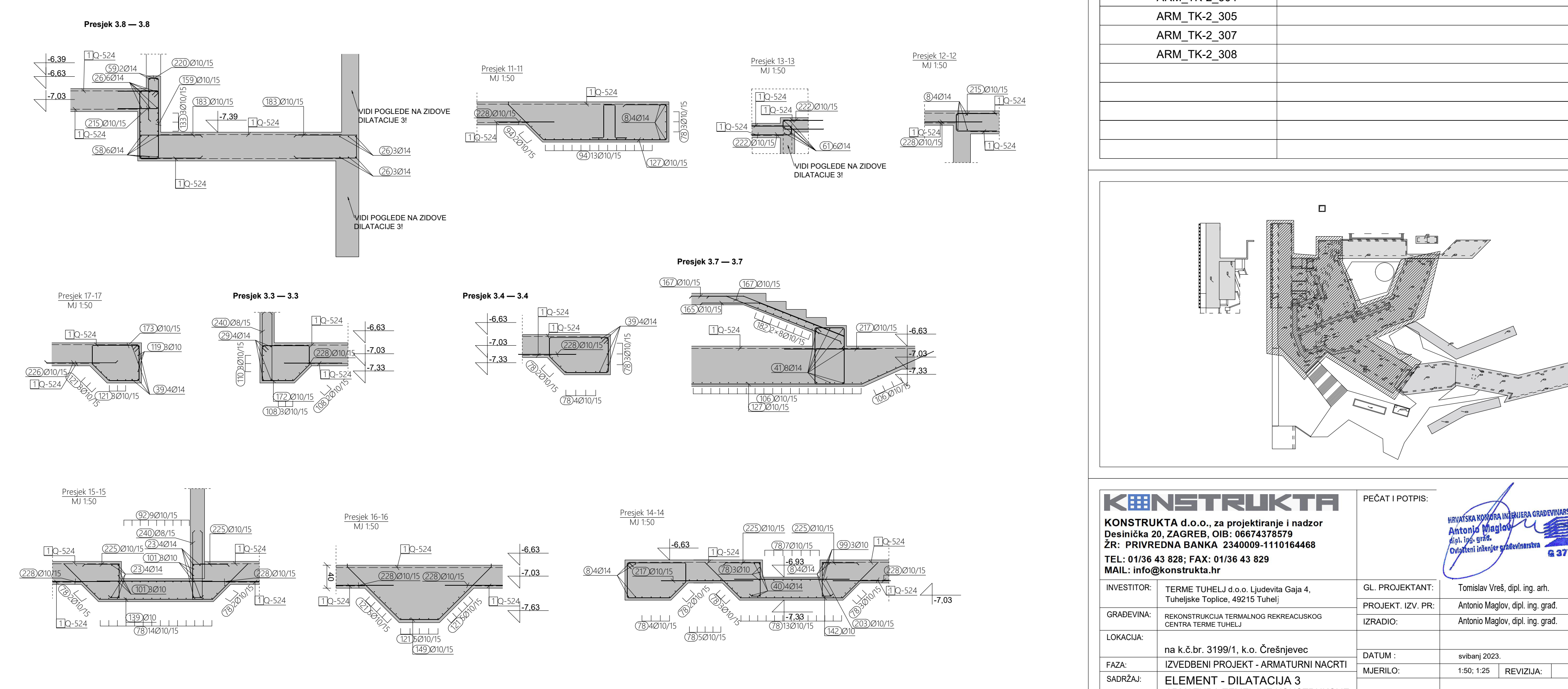
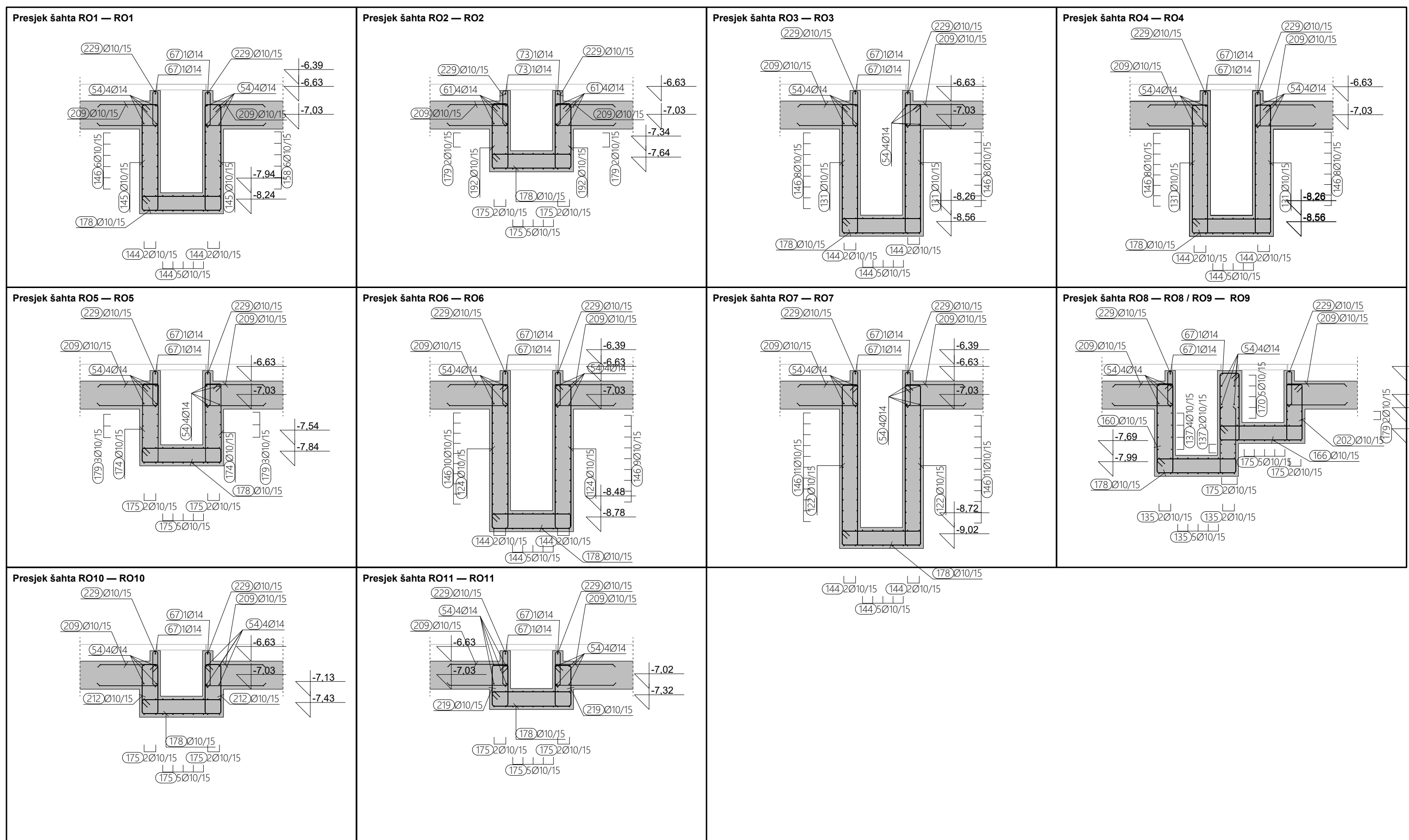
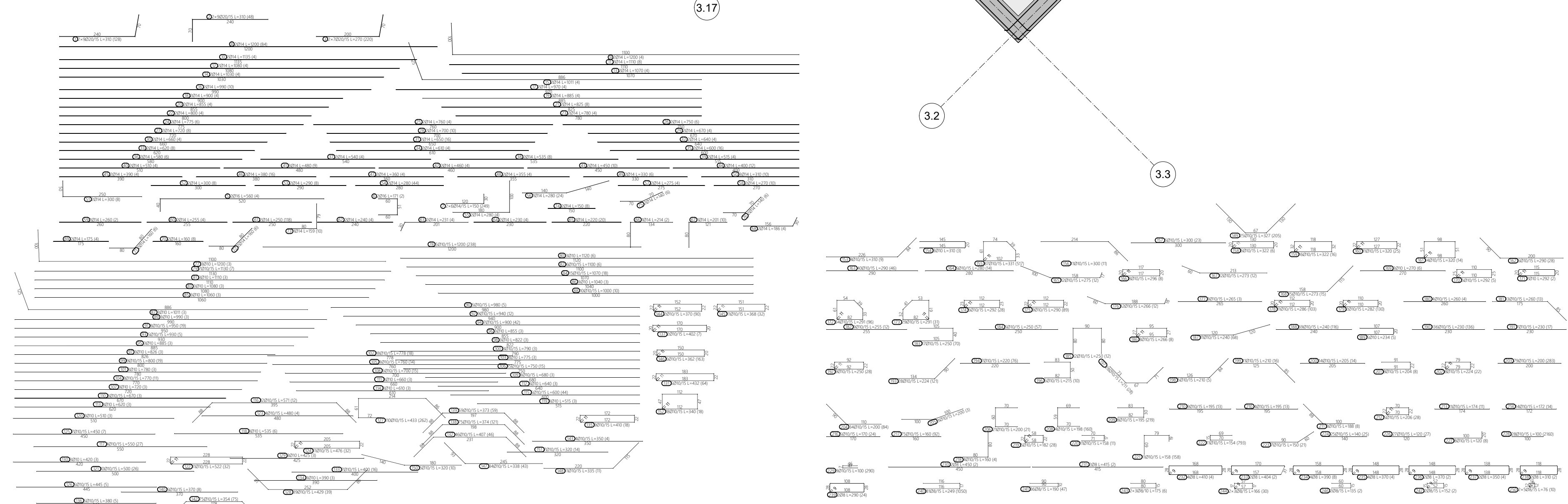
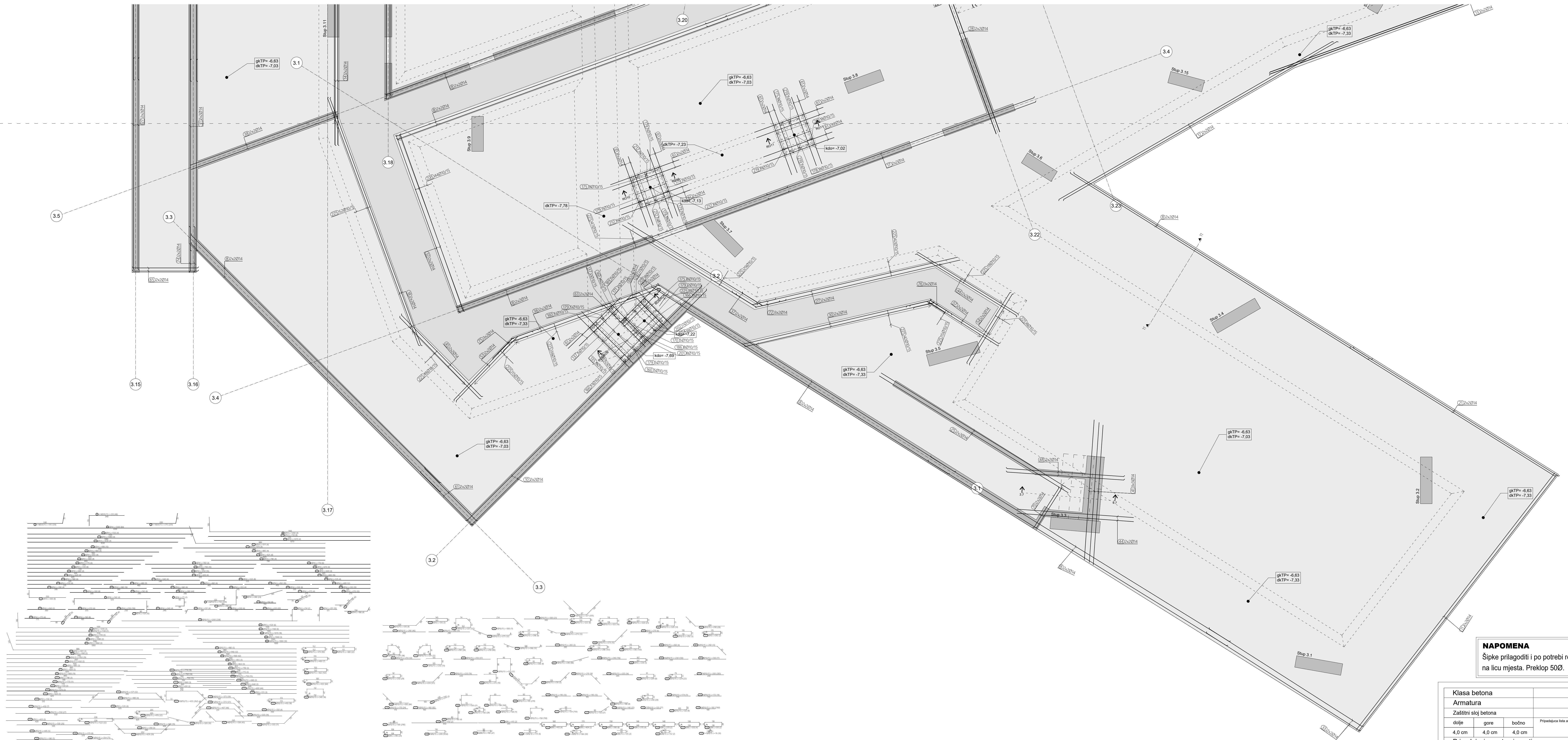

NAPOMENA
Šipke prilagoditi i po potrebi rezati na licu mjesta. Preklap 500.

NAPOMENA
Sve dimenzije provjeriti prema važećim planovima oplate.

Klasa betona	C 25/30
Armatura	B 500 B
Zaštitni sloj betona	
dole	gore
4,0 cm	4,0 cm
bočno	Pripadajući sloj armature
4,0 cm	ARM_TK-2_301-308_ISKAZ
Pripadajući armaturni nacrti	
ARM_TK-2_301	
ARM_TK-2_302	
ARM_TK-2_303	
ARM_TK-2_304	
ARM_TK-2_305	
ARM_TK-2_307	
ARM_TK-2_308	

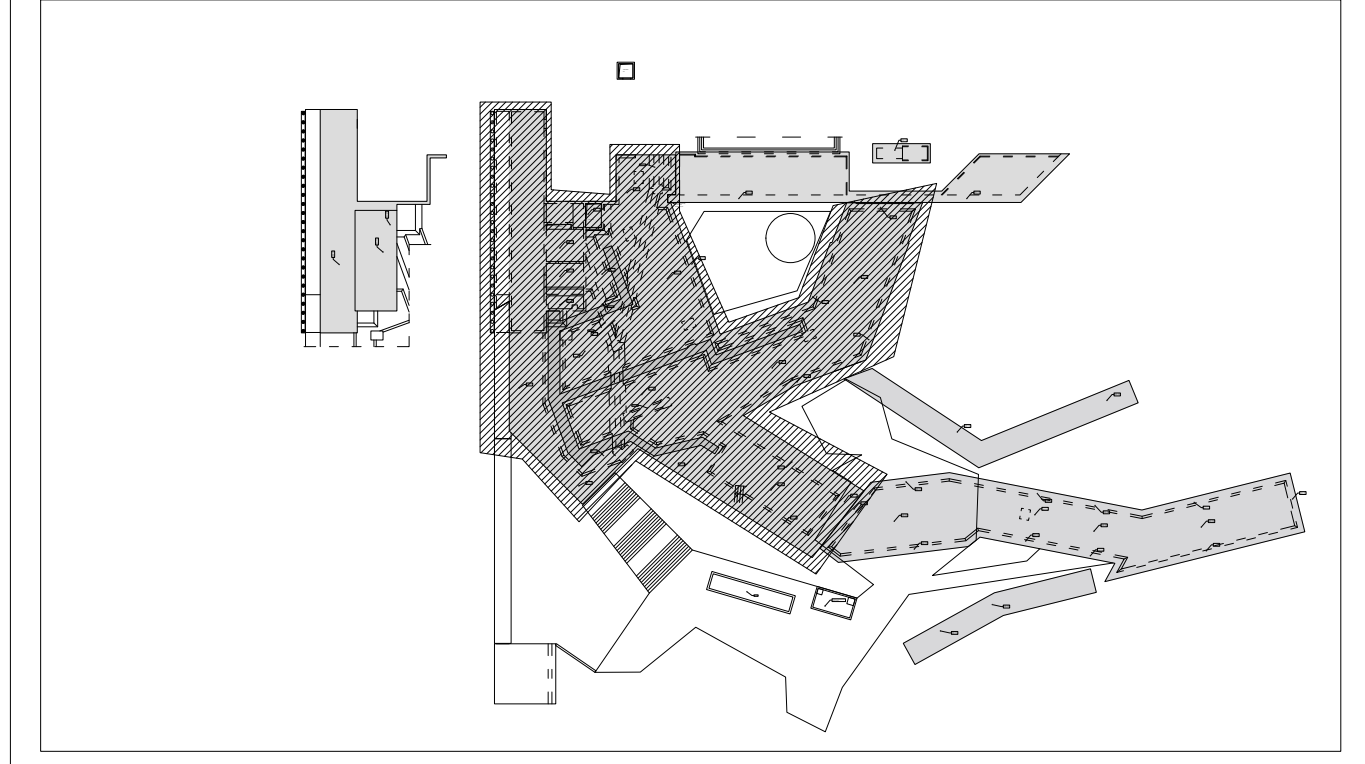

KONSTRUKTA PEČAT I POTPISE

KONSTRUKTA d.o.o., za projektiranje i nadzor
Desarićev 20, ZAGREB, OIB: 067437879
ZR: PRIVREDNA BANKA 2340009-1110164468
TEL: 01136 43 838; FAX: 01136 43 829
MAIL: info@konstrakta.hr

INVESTITOR: TERME TUREŠKE d.o.o. Ujedinjena Galija 4, Turkeška Toplica, 48215 Turkeška

GRAĐEVINA: REKONSTRUKCIJA TERMANIANSKIH REKREACIJSKIH CENTARA TERME TURKEŠKA

LOKACIJA: na k.o.br. 3199/1, k.o. Črešnjevec

FAZA: IZVEDBENI PROJEKT - ARMATURNI NACRTI

SADRŽAJ: ELEMENT - DILATACIJA 3
ARMATURA TEMELJNE KONSTRUKCIJE
RUBNA ARMATURA 2/2

GL. PROJEKTANT: Tomislav Viteš, dipl. ing. arh.

PROJEKT. IZV. PR.: Antonio Maglov, dipl. ing. građ.

IZRAĐIO: Antonio Maglov, dipl. ing. građ.

DATUM: svibanj 2023.

MJERILO: 1:50 i 25

REVIZIJA: 00

NACRT BR.: **ARM - TK-2 - 306**

**NACRT SAVIJANJA ARMATURE TEMELJA TK-2
DILATACIJA 3
ANKERI, PROBOJNA, KONSTRUKTIVNA 1/2, M 1:50**

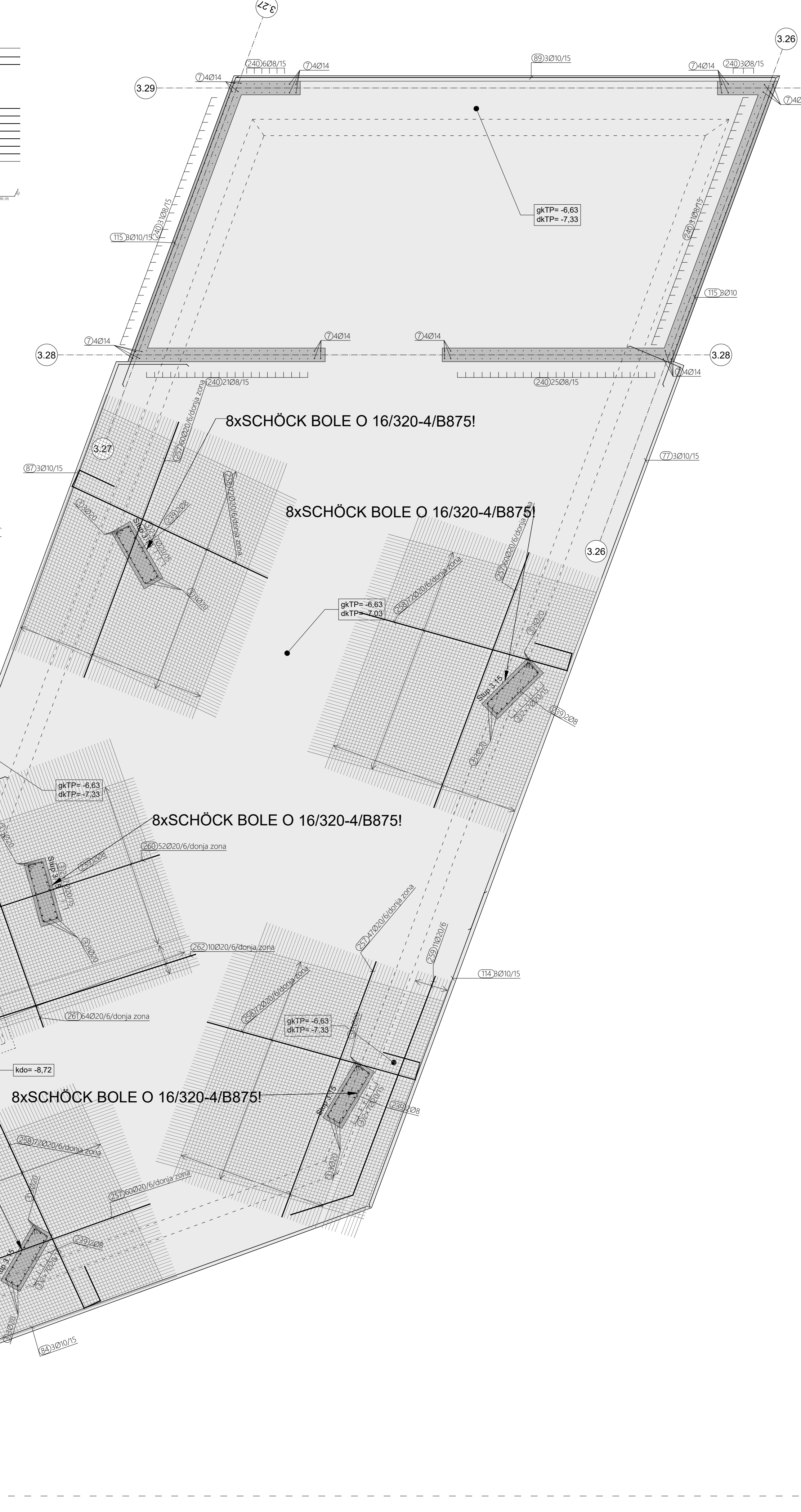
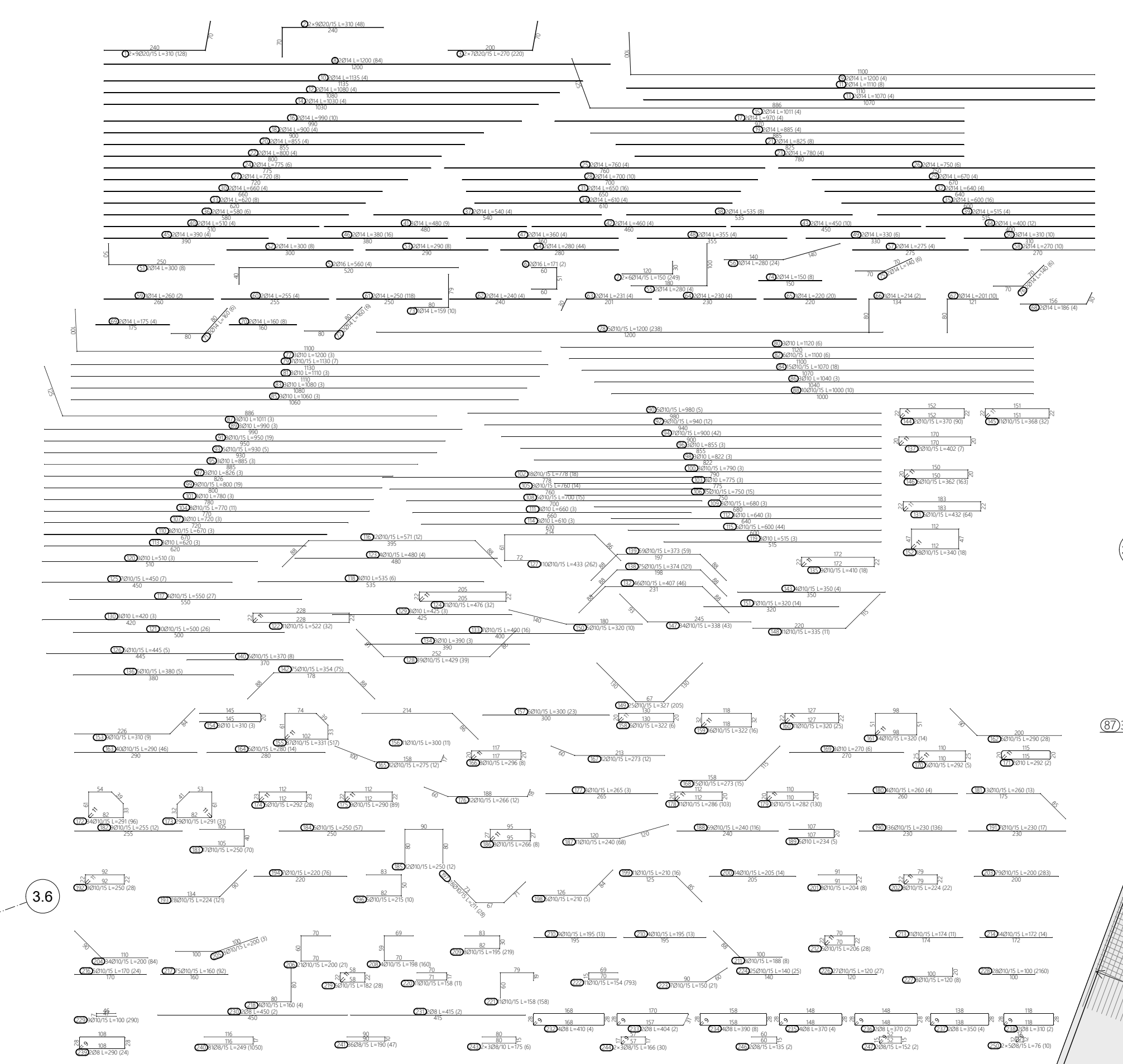
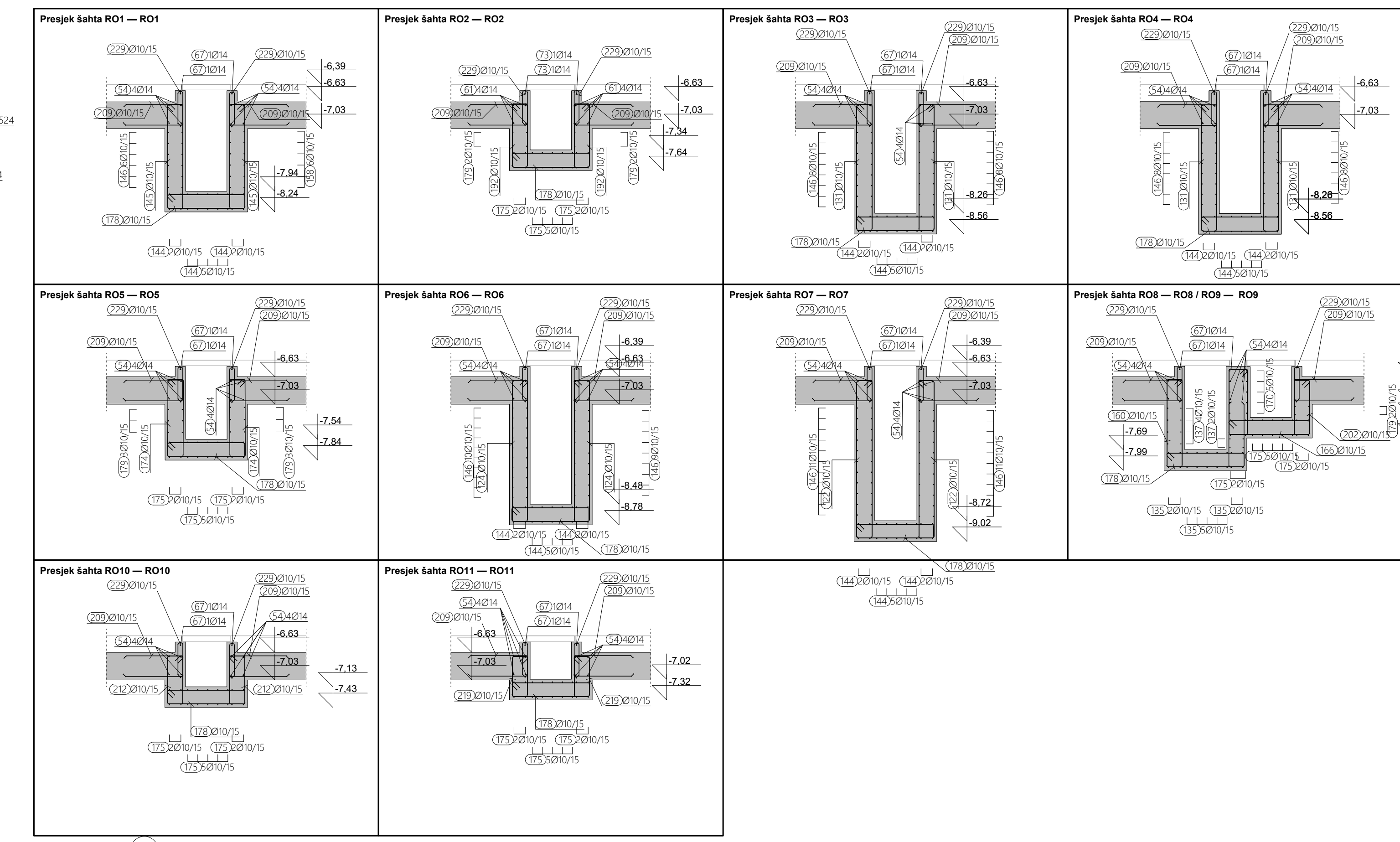
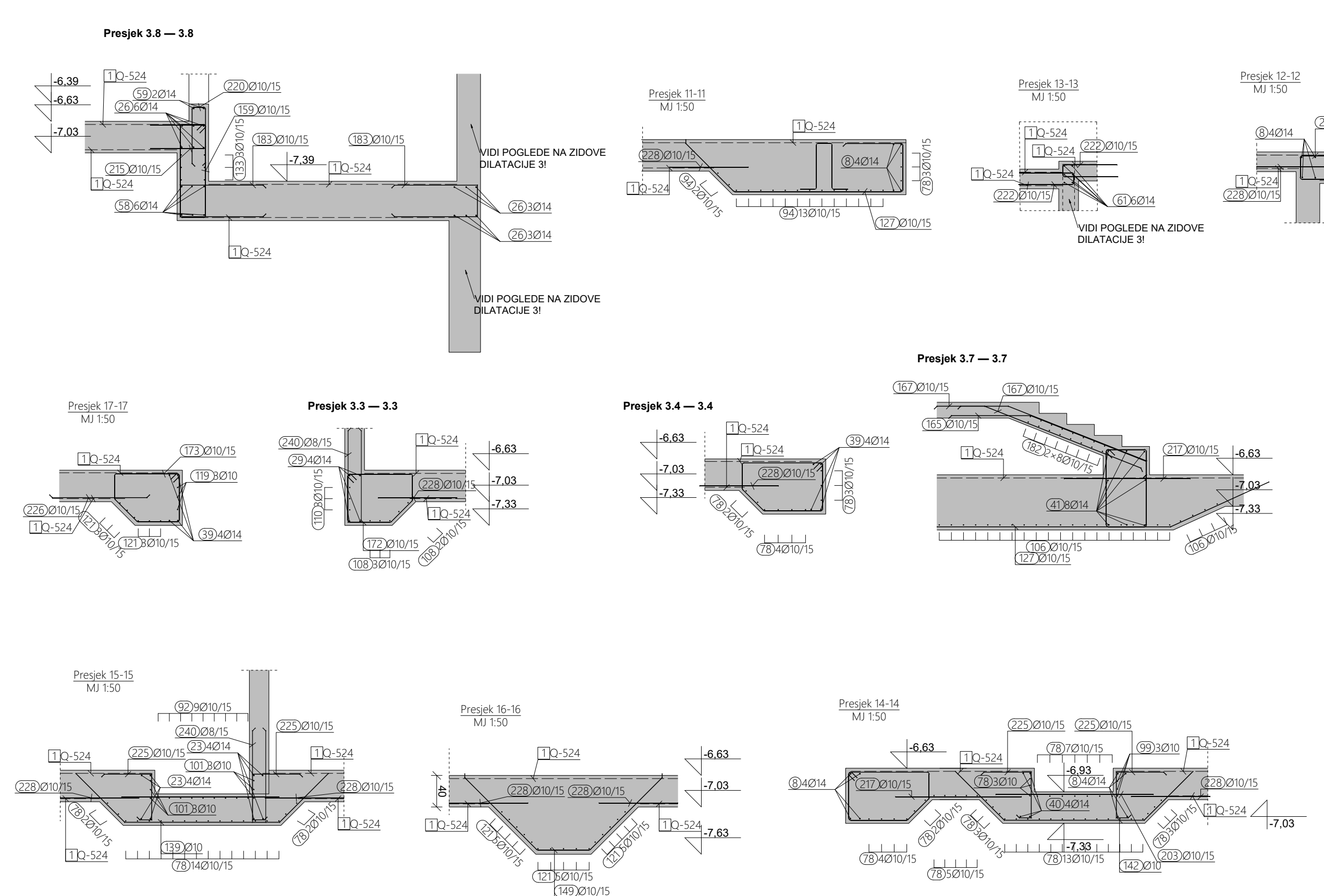
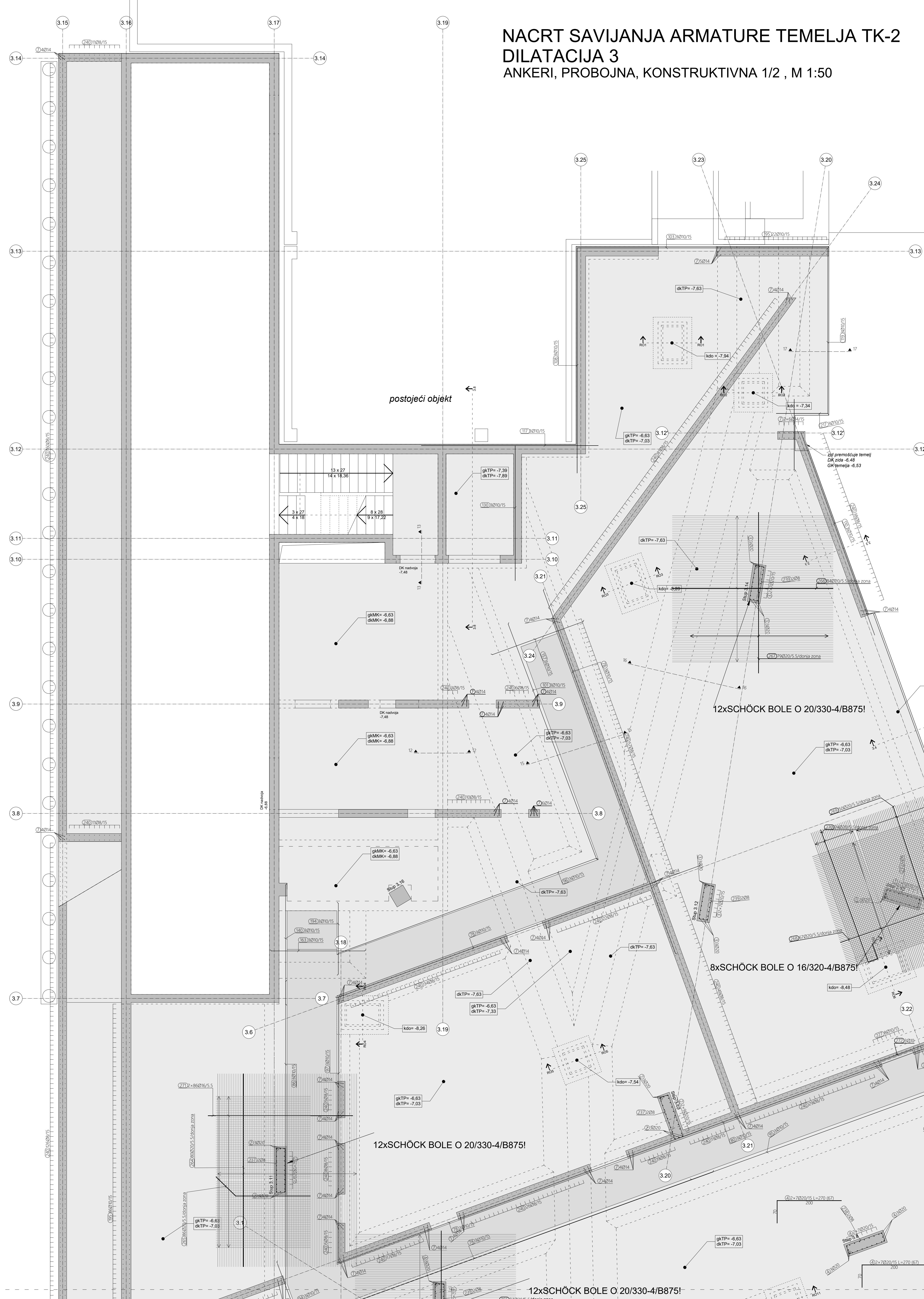

NAPOMENA
Šipke prilagoditi i po potrebi rezati na licu mjesta. Preklop 500.

NAPOMENA
Sve dimenzije provjeriti prema važećim planovima optate.

Klasa betona	C 25/30
Armatura	B 500 B
Zaštitni sloj betona	Pripadajućo optate
doje	gore
4,0 cm	4,0 cm
Pripadajući armaturni nacrti	
ARM_TK-2_301	
ARM_TK-2_302	
ARM_TK-2_303	
ARM_TK-2_304	
ARM_TK-2_305	
ARM_TK-2_306	
ARM_TK-2_308	

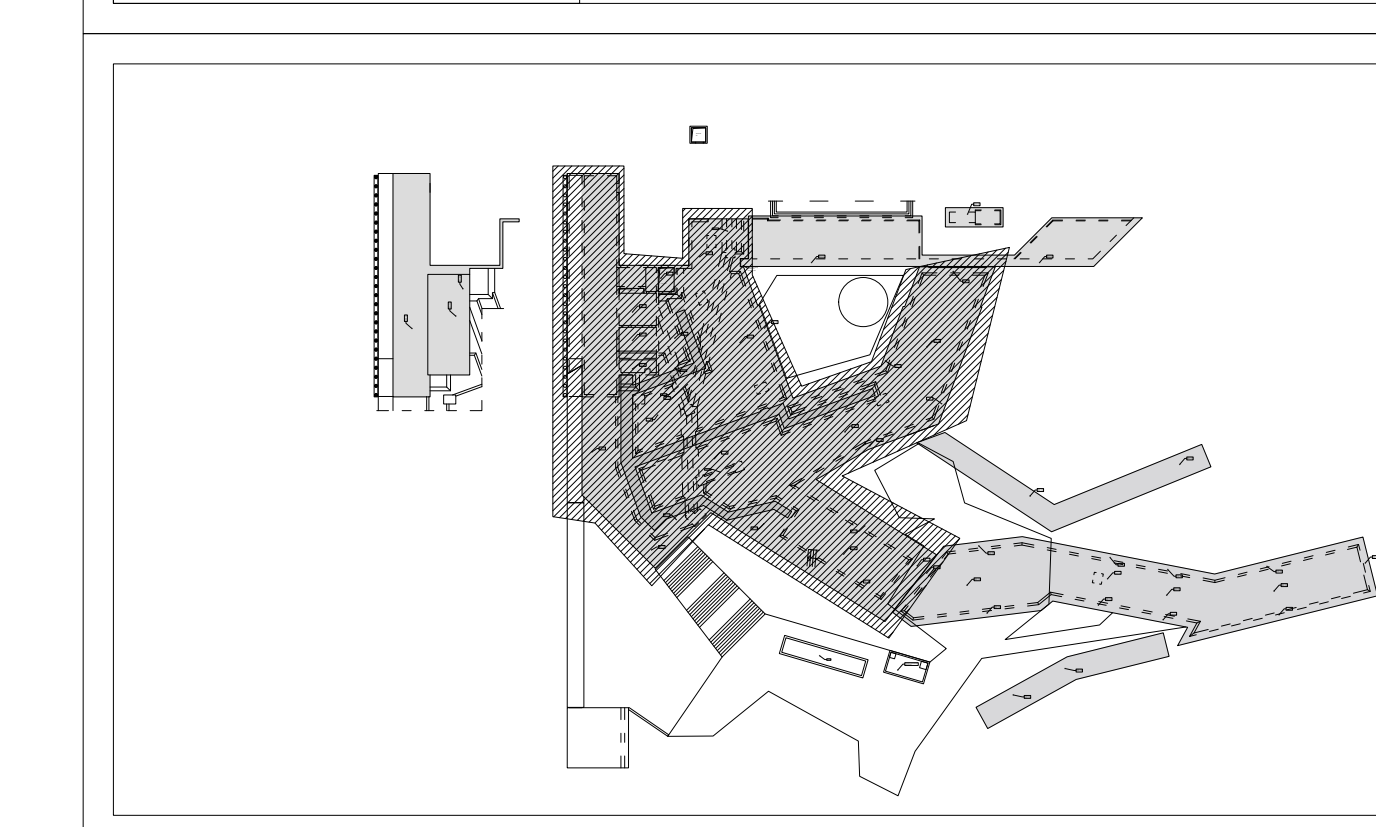

KONSTRUKTA		PEČAT I POTPIS:
KONSTRUKTA d.o.o. za projektiranje i nadzor Dionica 09, ZAGREB, OIB: 6967437099 ZIR: PRIVREDNA BANKA 2340009-110164668 TEL: 01136 43 828; FAX: 01136 43 829 MAIL: info@konstrakta.hr		
INVESTITOR	TERME TUHELJE d.o.o. Ljudevitova Gajka 4, Tuškanje Toplice, 49215 Tuškanje	GL. PROJEKTANT:
GRADJEVINA	REKONSTRUKCIJA TERMOBANSKE REKONSTRUKCIJE CENTRA TERME TUHELJE	PROJEKT. UV. PR. / OBRADIO:
LOKACIJA	na k.br. 3199/1, k.o. Orešjevec	ARMAT. / OBRADIO:
FAZA	IZVEDBENI PROJEKT - ARMATURNI NACRTI	MJERILO:
SADRŽAJ	ELEMENT - DILATACIJA 3 ARMATURA TEMELJNE KONSTRUKCIJE ANKERI, PROBOJNA, KONSTRUKTIVNA/12	1:50; 1:25; REVIDIJA: 00
NACRT BR:		ARM - TK-2 - 307

**NACRT SAVIJANJA ARMATURE TEMELJA TK-2
DILATACIJA 3**
ANKERI, PROBOJNA, KONSTRUKTIVNA 2/2 , M 1:50

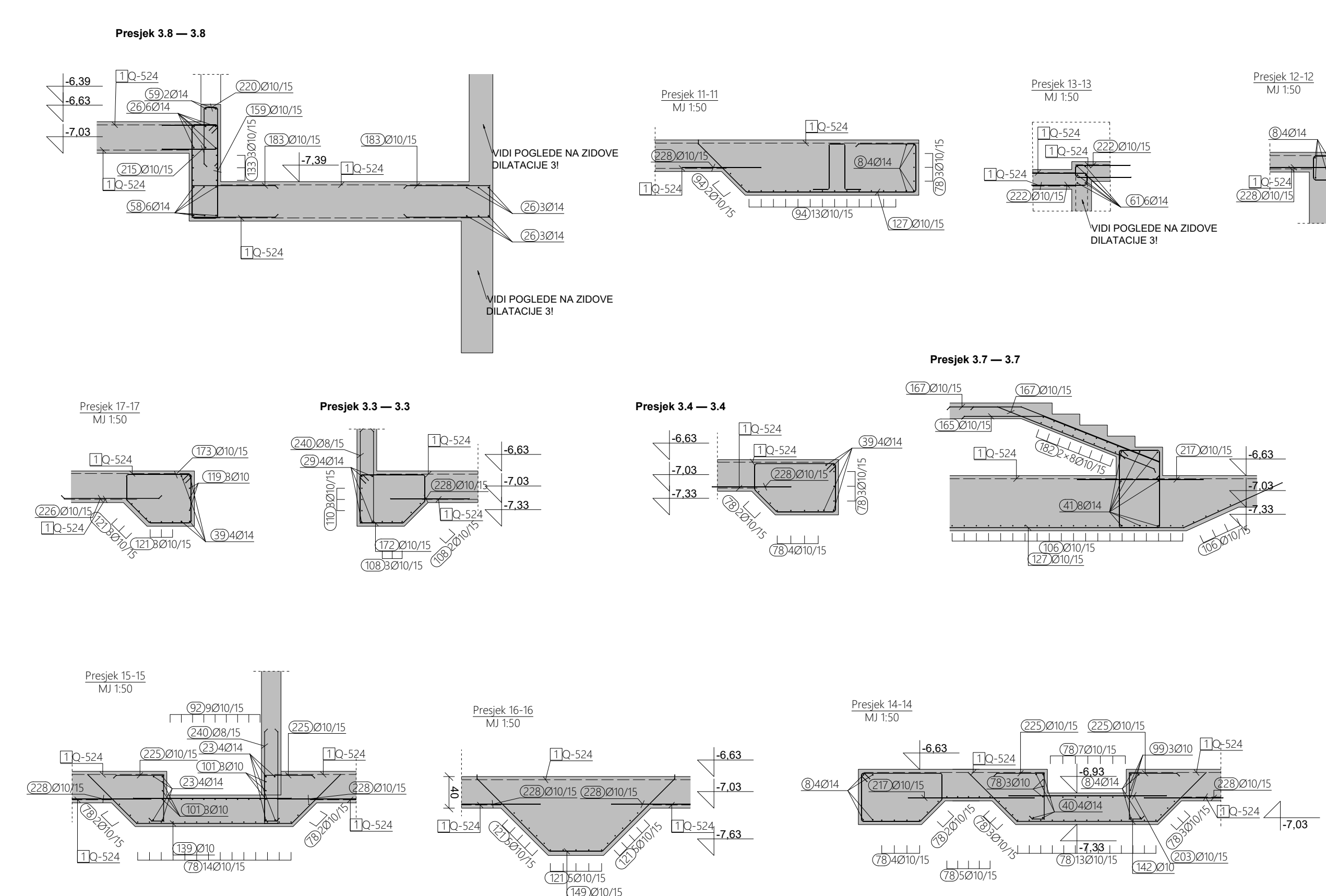
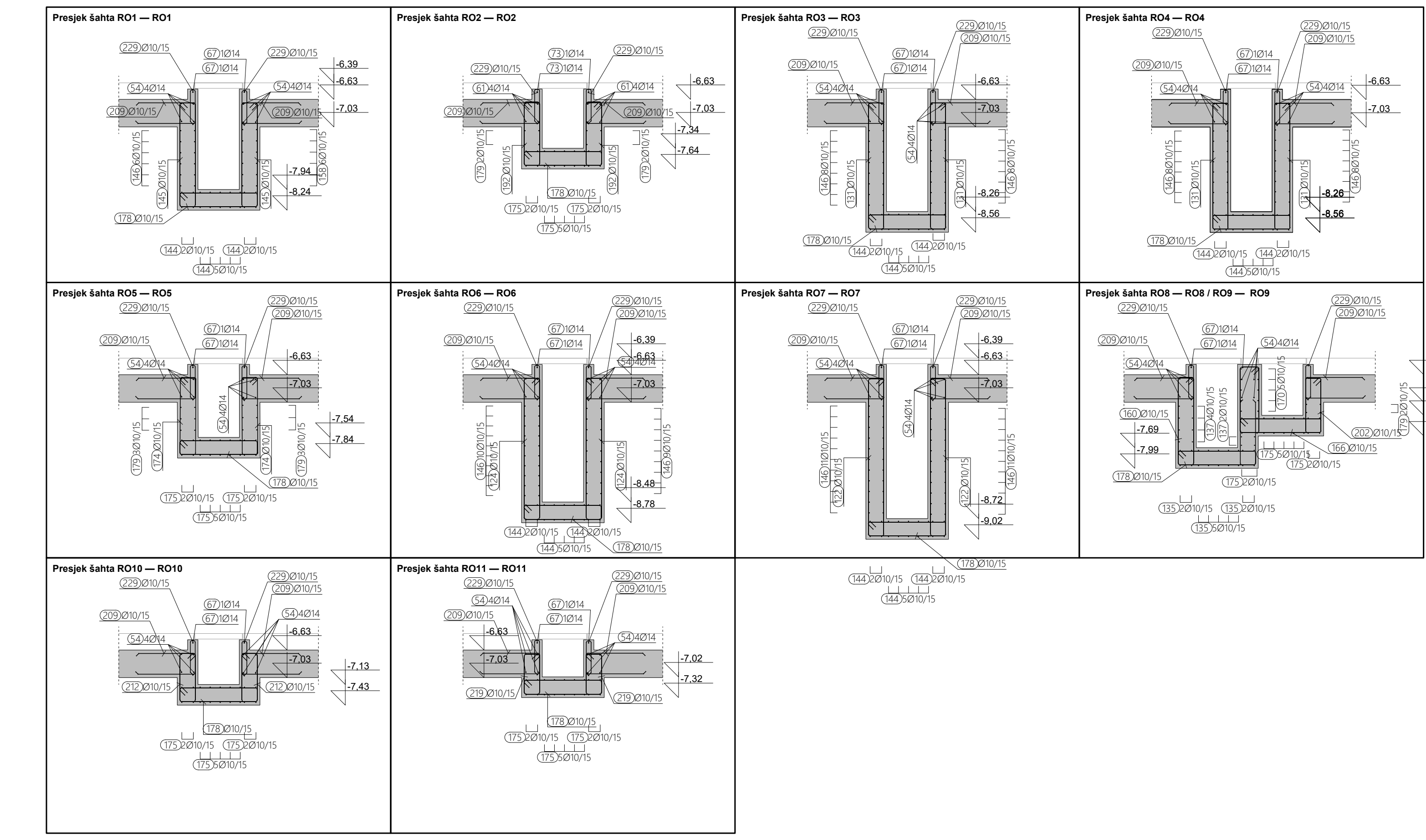
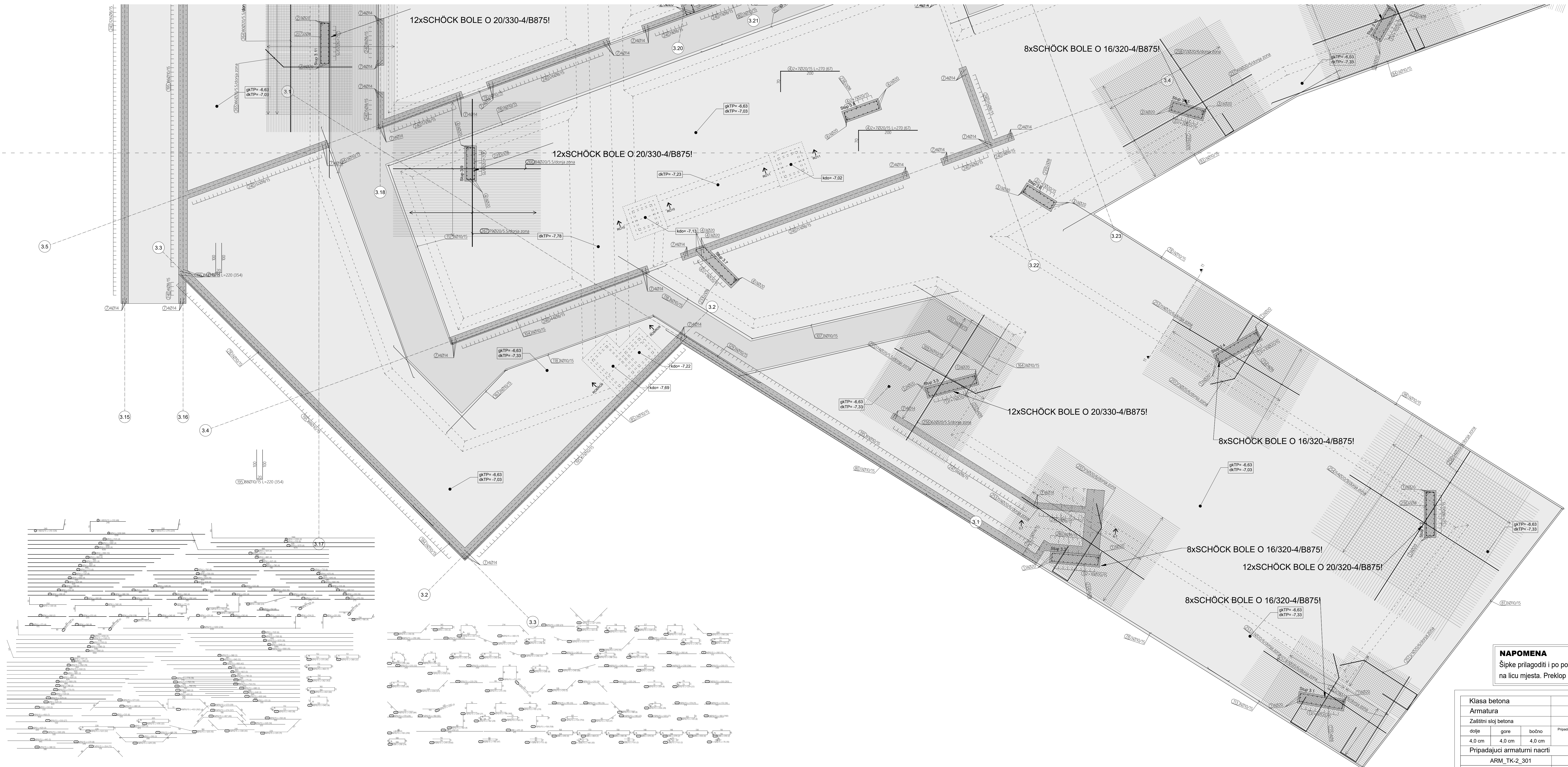

NAPOMENA
Šipke prilagoditi i po potrebi rezati na licu mjesta. Preklap 500.

NAPOMENA
Sve dimenzije provjeriti prema važećim planovima oplate.

Klasa betona	C 25/30
Armatura	B 500 B
Zaštitni sloj betona	
dole	gore
4,0 cm	4,0 cm
	bočno
	4,0 cm
Prilagoditi sloj armature: ARM_TK-2_301-308_ISKAZ	
Prilagoditi armaturni nacrti:	
ARM_TK-2_301	
ARM_TK-2_302	
ARM_TK-2_303	
ARM_TK-2_304	
ARM_TK-2_305	
ARM_TK-2_306	
ARM_TK-2_307	

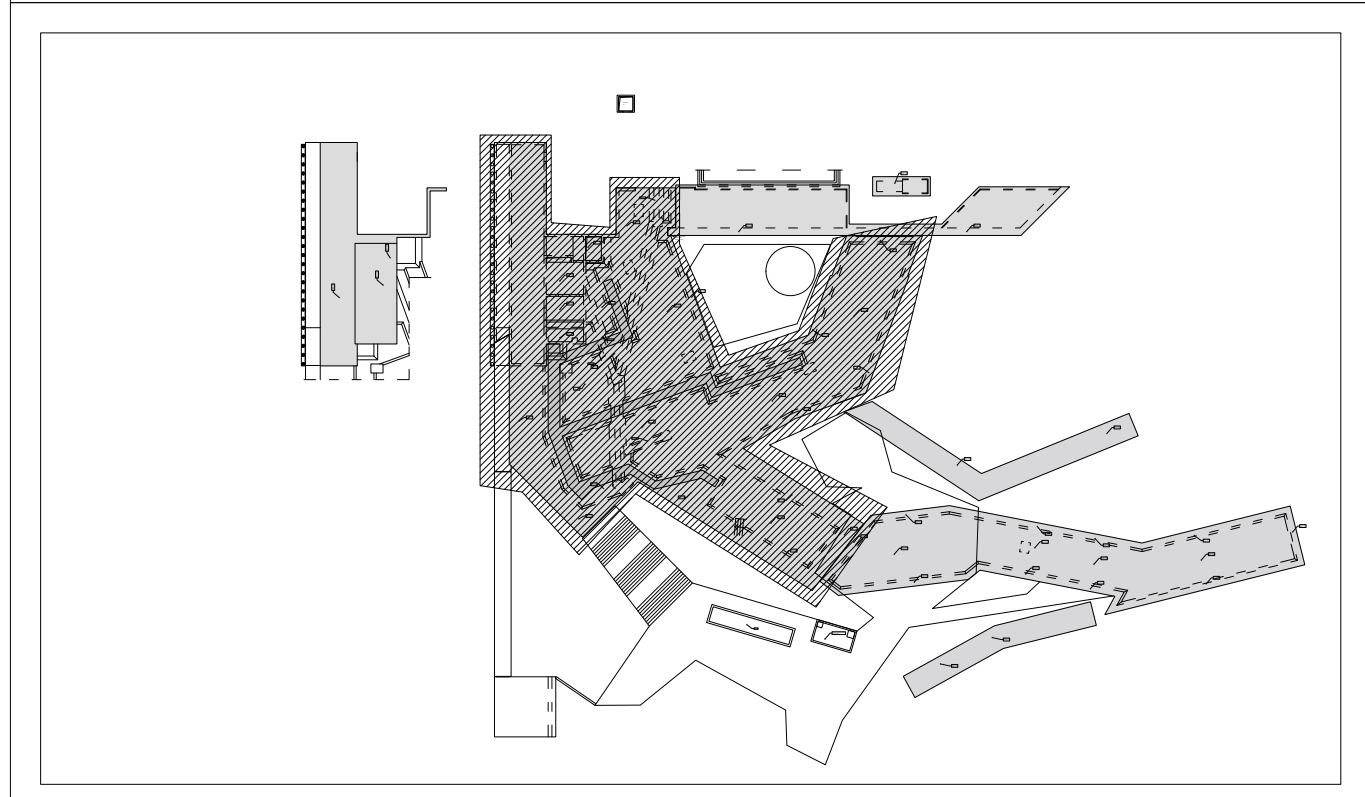

KONSTRUKTA PEČAT I POTPIŠ:

KONSTRUKTA d.o.o., za projektiranje i nadzor
Desarićeva 20, ZAGREB, OIB: 0667437879
ZR: PRIVREDNA BANKA 2340009-11016468
TEL: 01136 43 838; FAX: 01136 43 829
MAIL: info@konstrakta.hr

INVESTITOR: TERME TUNELI d.o.o. Ljudevit Gaja 4, Turkeška Toplica, 48215 Turin
GRAĐEVINA: REKONSTRUKCIJA TERMANANSKIH REKREACIJSKIH CENTARA TERME TURIN
LOKACIJA: na k.o.br. 3199/1, k.o. Črešnjevec
FAZA: IZVEDBENI PROJEKT - ARMATURNI NACRTI
SADRŽAJ: ELEMENT - DILATACIJA 3 ARMATURA TEMELNE KONSTRUKCIJE ANKERI, PROBOJNA, KONSTRUKTIVNA 2/2

GL. PROJEKTANT: Tomislav Viteš, dipl. ing. arh.
PROJEKT. IZV. PR: Antonio Maglov, dipl. ing. građ.
URADIO: Antonio Maglov, dipl. ing. građ.

DATUM: svibanj 2023.
MJESECI: 1.50.1.25
REVIZIJA: 00

NACRT BR: **ARM - TK-2 - 308**

ISKAZ ARMATURE		
GRAĐEVINA:	REKONSTRUKCIJA TERMALNOG REK. CENT. TERME TUHELJ	
ISKAZ UZ NACRT:	ARM-TK-2-301-308	
SADRŽAJ:	ARMATURA TEMELJA -2	
DATUM:	24/06/2023	1/23

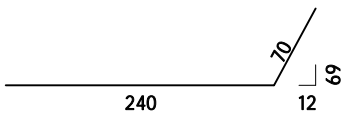
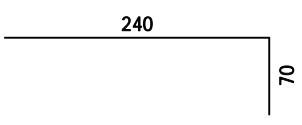
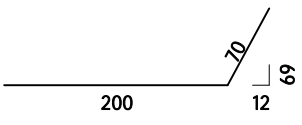
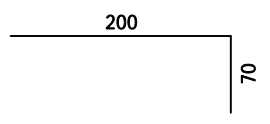
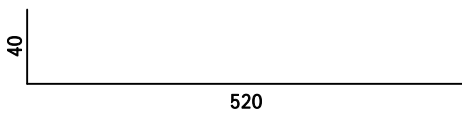
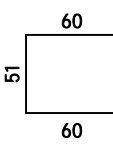
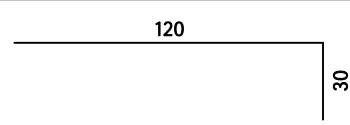
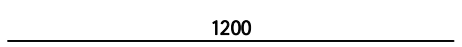
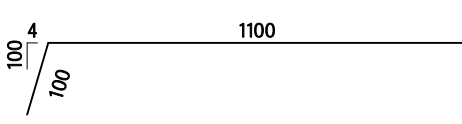
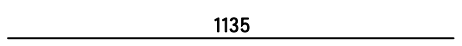
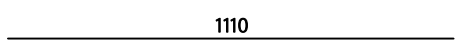
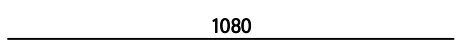
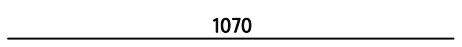
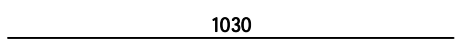
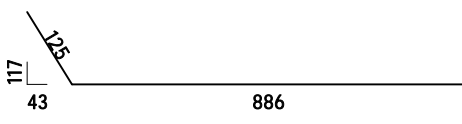
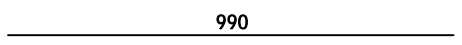
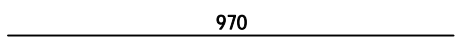





Šipke - specifikacija						
ozn	oblik i mjere [cm]	Ø	lg [m]	n [kom]	lgn [m]	Napomena
TK-DIL 3 - 2 - TEMELJNA KONSTRUKCIJA - (1 kom)						
1		20	3.10	128	396.80	
2		20	3.10	48	148.80	
3		20	2.70	220	594.00	
4		20	2.70	67	180.90	
5		16	5.60	4	22.40	
6		16	1.71	2	3.42	
7		14	1.50	249	373.50	
8		14	12.00	84	1008.00	
9		14	12.00	4	48.00	
10		14	11.35	4	45.40	
11		14	11.10	8	88.80	
12		14	10.80	4	43.20	
13		14	10.70	4	42.80	
14		14	10.30	4	41.20	
15		14	10.11	4	40.44	
16		14	9.90	10	99.00	
17		14	9.70	4	38.80	

ISKAZ ARMATURE		
GRAĐEVINA:	REKONSTRUKCIJA TERMALNOG REK. CENT. TERME TUHELJ	
ISKAZ UZ NACRT:	ARM-TK-2-301-308	
SADRŽAJ:	ARMATURA TEMELJA -2	
DATUM:	24/06/2023	2/23

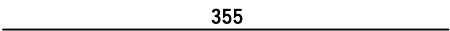
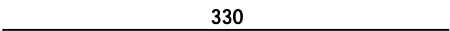
Šipke - specifikacija						
ozn	oblik i mjere [cm]	Ø	lg [m]	n [kom]	lgn [m]	Napomena
18	900	14	9.00	4	36.00	
19	885	14	8.85	4	35.40	
20	855	14	8.55	4	34.20	
21	825	14	8.25	8	66.00	
22	800	14	8.00	4	32.00	
23	780	14	7.80	4	31.20	
24	775	14	7.75	6	46.50	
25	760	14	7.60	4	30.40	
26	750	14	7.50	6	45.00	
27	720	14	7.20	8	57.60	
28	700	14	7.00	10	70.00	
29	670	14	6.70	4	26.80	
30	660	14	6.60	4	26.40	
31	650	14	6.50	16	104.00	
32	640	14	6.40	4	25.60	
33	620	14	6.20	8	49.60	
34	610	14	6.10	4	24.40	
35	600	14	6.00	16	96.00	
36	580	14	5.80	6	34.80	
37	540	14	5.40	4	21.60	
38	535	14	5.35	8	42.80	
39	515	14	5.15	4	20.60	
40	510	14	5.10	4	20.40	
41	480	14	4.80	9	43.20	
42	460	14	4.60	4	18.40	
43	450	14	4.50	10	45.00	
44	400	14	4.00	12	48.00	
45	390	14	3.90	4	15.60	
46	380	14	3.80	16	60.80	
47	360	14	3.60	4	14.40	

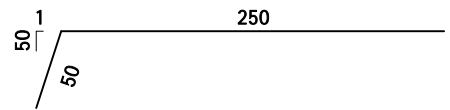
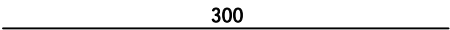
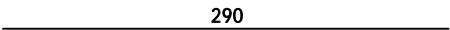
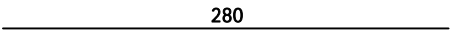
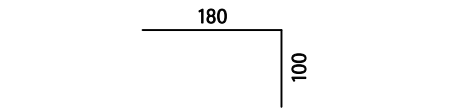
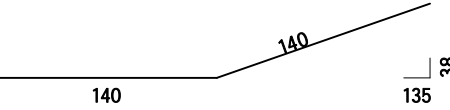
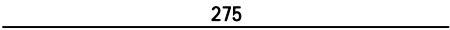
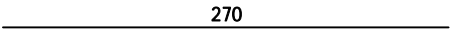
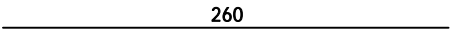
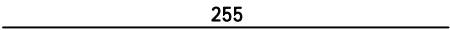
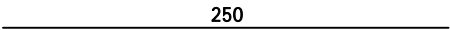
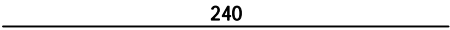
ISKAZ ARMATURE

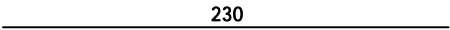
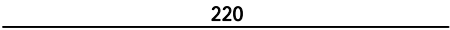
GRAĐEVINA:	REKONSTRUKCIJA TERMALNOG REK. CENT. TERME TUHELJ	
ISKAZ UZ NACRT:	ARM-TK-2-301-308	
SADRŽAJ:	ARMATURA TEMELJA -2	
DATUM:	24/06/2023	3/23

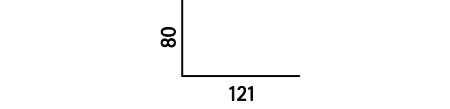
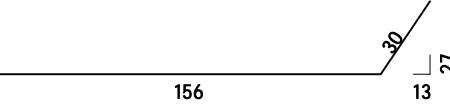
Šipke - specifikacija						
ozn	oblik i mjere [cm]	Ø	lg [m]	n [kom]	lgn [m]	Napomena
48		14	3.55	4	14.20	
49		14	3.30	6	19.80	
50		14	3.10	10	31.00	
51		14	3.00	8	24.00	
52		14	3.00	8	24.00	
53		14	2.90	8	23.20	
54		14	2.80	44	123.20	
55		14	2.80	4	11.20	
56		14	2.80	24	67.20	
57		14	2.75	4	11.00	
58		14	2.70	10	27.00	
59		14	2.60	2	5.20	
60		14	2.55	4	10.20	
61		14	2.50	118	295.00	
62		14	2.40	4	9.60	
63		14	2.31	4	9.24	
64		14	2.30	4	9.20	
65		14	2.20	20	44.00	
66		14	2.14	2	4.28	
67		14	2.01	10	20.10	
68		14	1.86	4	7.44	

ISKAZ ARMATURE

GRAĐEVINA:	REKONSTRUKCIJA TERMALNOG REK. CENT. TERME TUHELJ		
ISKAZ UZ NACRT:	ARM-TK-2-301-308		
SADRŽAJ:	ARMATURA TEMELJA -2		
DATUM:	24/06/2023		4/23

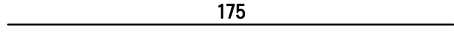
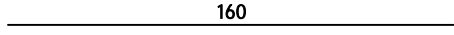
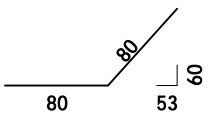
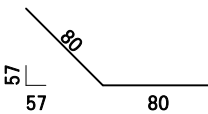
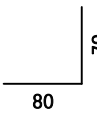
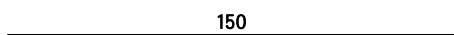
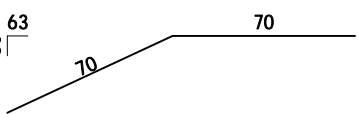
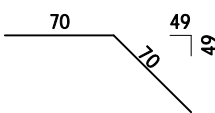
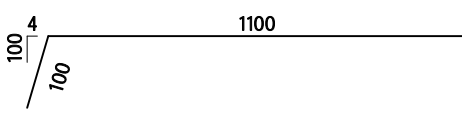
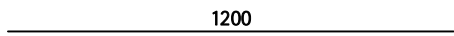
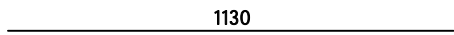
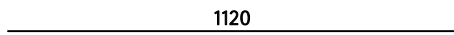
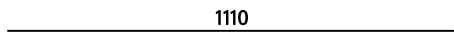
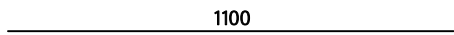
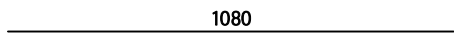
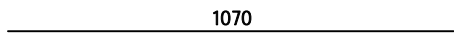
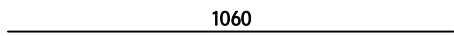
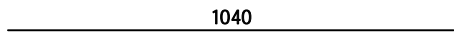
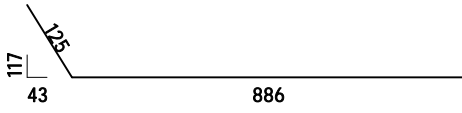
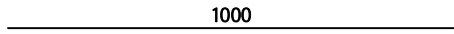
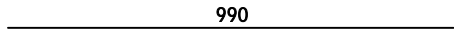
Šipke - specifikacija						
ozn	oblik i mjere [cm]	Ø	lg [m]	n [kom]	lgn [m]	Napomena
69		14	1.75	4	7.00	
70		14	1.60	8	12.80	
71		14	1.60	6	9.60	
72		14	1.60	6	9.60	
73		14	1.59	10	15.90	
74		14	1.50	8	12.00	
75		14	1.40	6	8.40	
76		14	1.40	6	8.40	
77		10	12.00	3	36.00	
78		10	12.00	238	2856.00	
79		10	11.30	7	79.10	
80		10	11.20	6	67.20	
81		10	11.10	3	33.30	
82		10	11.00	6	66.00	
83		10	10.80	3	32.40	
84		10	10.70	18	192.60	
85		10	10.60	3	31.80	
86		10	10.40	3	31.20	
87		10	10.11	3	30.33	
88		10	10.00	10	100.00	
89		10	9.90	3	29.70	







ISKAZ ARMATURE

GRAĐEVINA:	REKONSTRUKCIJA TERMALNOG REK. CENT. TERME TUHELJ	
ISKAZ UZ NACRT:	ARM-TK-2-301-308	
SADRŽAJ:	ARMATURA TEMELJA -2	
DATUM:	24/06/2023	5/23

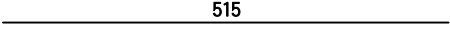
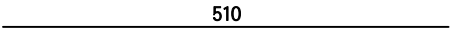
Šipke - specifikacija						
ozn	oblik i mjere [cm]	Ø	lg [m]	n [kom]	lgn [m]	Napomena
90	980	10	9.80	5	49.00	
91	950	10	9.50	19	180.50	
92	940	10	9.40	12	112.80	
93	930	10	9.30	5	46.50	
94	900	10	9.00	42	378.00	
95	885	10	8.85	3	26.55	
96	855	10	8.55	3	25.65	
97	826	10	8.26	3	24.78	
98	822	10	8.22	3	24.66	
99	800	10	8.00	19	152.00	
100	790	10	7.90	3	23.70	
101	780	10	7.80	3	23.40	
102	778	10	7.78	18	140.04	
103	775	10	7.75	3	23.25	
104	770	10	7.70	11	84.70	
105	760	10	7.60	14	106.40	
106	750	10	7.50	15	112.50	
107	720	10	7.20	3	21.60	
108	700	10	7.00	15	105.00	
109	680	10	6.80	3	20.40	
110	670	10	6.70	3	20.10	
111	660	10	6.60	3	19.80	
112	640	10	6.40	3	19.20	
113	620	10	6.20	3	18.60	
114	610	10	6.10	3	18.30	
115	600	10	6.00	44	264.00	
116		10	5.71	12	68.52	
117	550	10	5.50	27	148.50	
118	535	10	5.35	6	32.10	

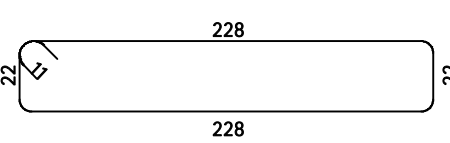

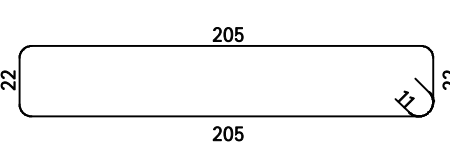
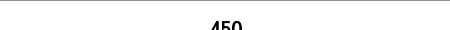
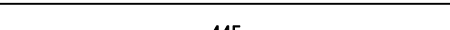
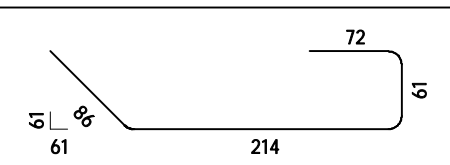
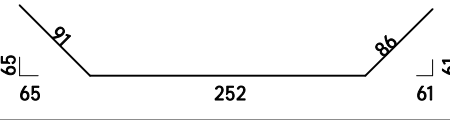
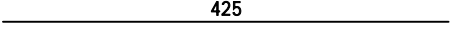
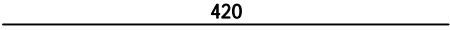
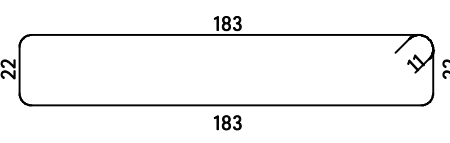

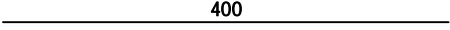
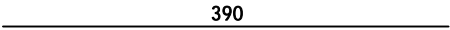
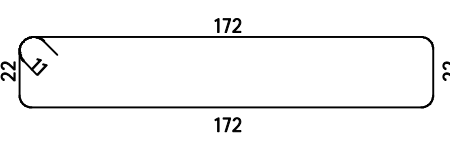
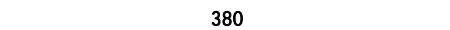
ISKAZ ARMATURE

GRAĐEVINA:	REKONSTRUKCIJA TERMALNOG REK. CENT. TERME TUHELJ	
ISKAZ UZ NACRT:	ARM-TK-2-301-308	
SADRŽAJ:	ARMATURA TEMELJA -2	
DATUM:	24/06/2023	6/23

Šipke - specifikacija						
ozn	oblik i mjere [cm]	Ø	lg [m]	n [kom]	lgn [m]	Napomena
119	 515	10	5.15	3	15.45	
120	 510	10	5.10	3	15.30	
121	 500	10	5.00	26	130.00	
122	 228 22 41 22	10	5.22	32	167.04	
123	 480	10	4.80	4	19.20	
124	 205 22 41 22	10	4.76	32	152.32	
125	 450	10	4.50	7	31.50	
126	 445	10	4.45	5	22.25	
127	 72 61 86 61 214	10	4.33	262	1134.46	
128	 91 86 61 65 65 252 61	10	4.29	39	167.31	
129	 425	10	4.25	3	12.75	
130	 420	10	4.20	3	12.60	
131	 183 22 11 22	10	4.32	64	276.48	
132	 88 88 63 62 62 231 62	10	4.07	46	187.22	
133	 400	10	4.00	16	64.00	
134	 390	10	3.90	3	11.70	
135	 172 22 41 22	10	4.10	18	73.80	
136	 380	10	3.80	5	19.00	

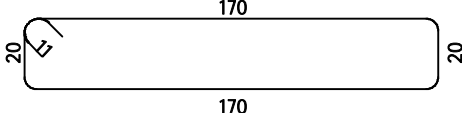
ISKAZ ARMATURE

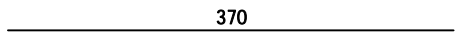
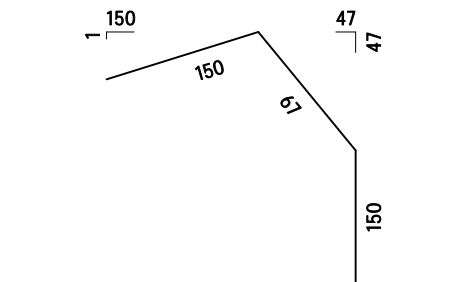
GRAĐEVINA:	REKONSTRUKCIJA TERMALNOG REK. CENT. TERME TUHELJ	
ISKAZ UZ NACRT:	ARM-TK-2-301-308	
SADRŽAJ:	ARMATURA TEMELJA -2	
DATUM:	24/06/2023	7/23

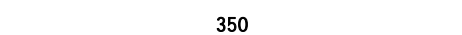
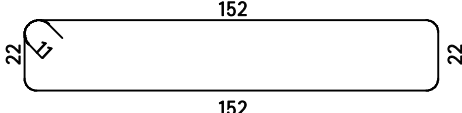
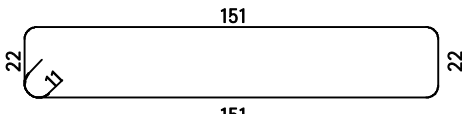
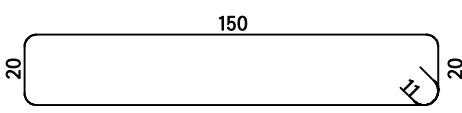
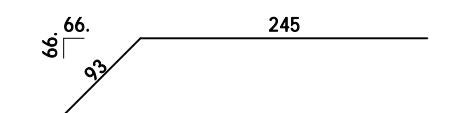
Šipke - specifikacija						
ozn	oblik i mjere [cm]	Ø	lg [m]	n [kom]	lgn [m]	Napomena
137		10	4.02	7	28.14	
138		10	3.74	121	452.54	
139		10	3.73	59	220.07	
140		10	3.70	8	29.60	
141		10	3.67	85	311.95	
142		10	3.54	75	265.50	
143		10	3.50	4	14.00	
144		10	3.70	90	333.00	
145		10	3.68	32	117.76	
146		10	3.62	163	590.06	
147		10	3.38	43	145.34	

ISKAZ ARMATURE

GRAĐEVINA:	REKONSTRUKCIJA TERMALNOG REK. CENT. TERME TUHELJ	
ISKAZ UZ NACRT:	ARM-TK-2-301-308	
SADRŽAJ:	ARMATURA TEMELJA -2	
DATUM:	24/06/2023	8/23

Šipke - specifikacija

ozn	oblik i mjere [cm]	Ø	lg [m]	n [kom]	lgn [m]	Napomena
148		10	3.35	11	36.85	
149		10	3.27	205	670.35	
150		10	3.20	10	32.00	
151		10	3.20	14	44.80	
152		10	3.40	18	61.20	
153		10	3.10	9	27.90	
154		10	3.10	3	9.30	
155		10	3.31	517	1711.27	
156		10	3.00	11	33.00	
157		10	3.00	23	69.00	
158		10	3.22	6	19.32	

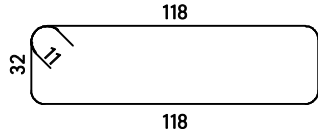
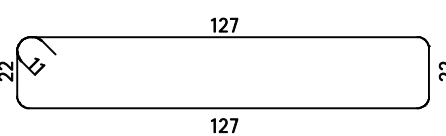
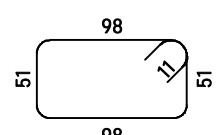
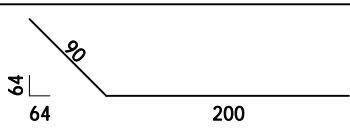
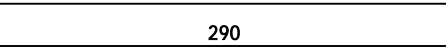
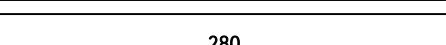
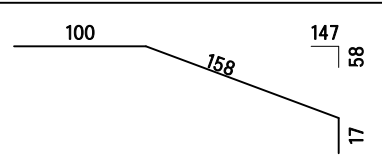
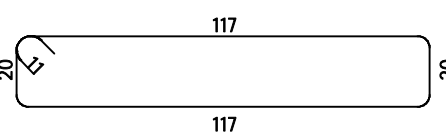
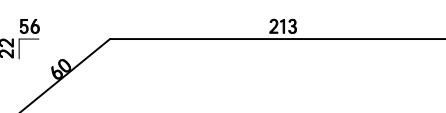
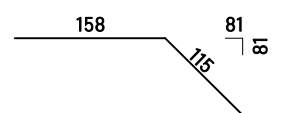
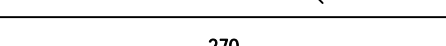
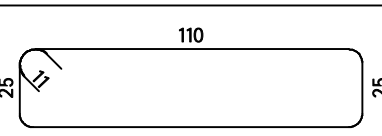
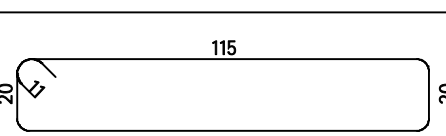

ISKAZ ARMATURE

GRAĐEVINA:	REKONSTRUKCIJA TERMALNOG REK. CENT. TERME TUHELJ	
ISKAZ UZ NACRT:	ARM-TK-2-301-308	
SADRŽAJ:	ARMATURA TEMELJA -2	
DATUM:	24/06/2023	9/23

Šipke - specifikacija						
ozn	oblik i mjere [cm]	Ø	lg [m]	n [kom]	lgn [m]	Napomena
159		10	3.22	16	51.52	
160		10	3.20	25	80.00	
161		10	3.20	14	44.80	
162		10	2.90	28	81.20	
163		10	2.90	46	133.40	
164		10	2.80	14	39.20	
165		10	2.75	12	33.00	
166		10	2.96	8	23.68	
167		10	2.73	12	32.76	
168		10	2.73	15	40.95	
169		10	2.70	6	16.20	
170		10	2.92	5	14.60	
171		10	2.92	2	5.84	

ISKAZ ARMATURE

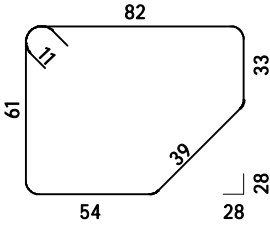
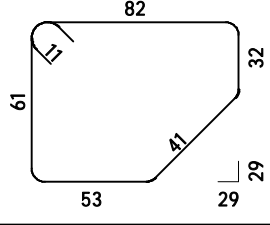
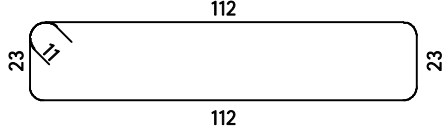
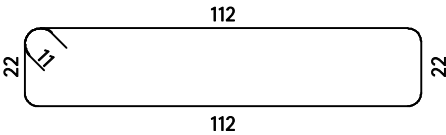
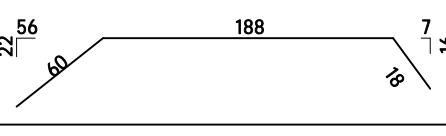
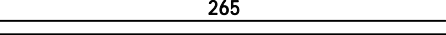
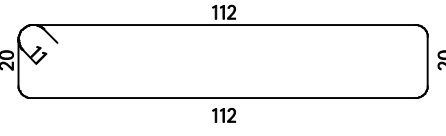
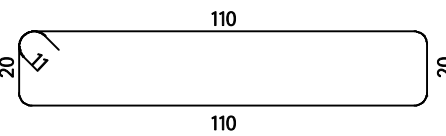
GRAĐEVINA:	REKONSTRUKCIJA TERMALNOG REK. CENT. TERME TUHELJ	
ISKAZ UZ NACRT:	ARM-TK-2-301-308	
SADRŽAJ:	ARMATURA TEMELJA -2	
DATUM:	24/06/2023	10/23

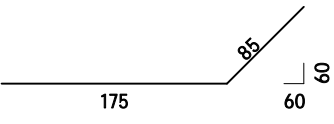
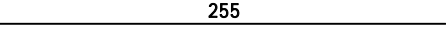
Šipke - specifikacija						
ozn	oblik i mjere [cm]	Ø	lg [m]	n [kom]	lgn [m]	Napomena
172		10	2.91	96	279.36	
173		10	2.91	31	90.21	
174		10	2.92	28	81.76	
175		10	2.90	89	258.10	
176		10	2.66	12	31.92	
177		10	2.65	3	7.95	
178		10	2.86	103	294.58	
179		10	2.82	130	366.60	
180		10	2.60	4	10.40	
181		10	2.60	13	33.80	
182		10	2.55	12	30.60	

ISKAZ ARMATURE

GRAĐEVINA:	REKONSTRUKCIJA TERMALNOG REK. CENT. TERME TUHELJ	
ISKAZ UZ NACRT:	ARM-TK-2-301-308	
SADRŽAJ:	ARMATURA TEMELJA -2	
DATUM:	24/06/2023	11/23

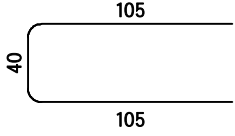
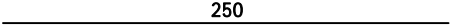
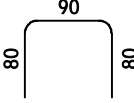
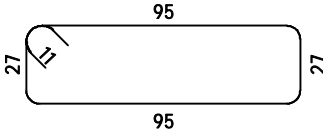
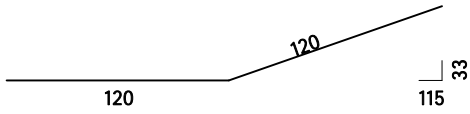
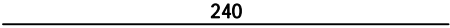
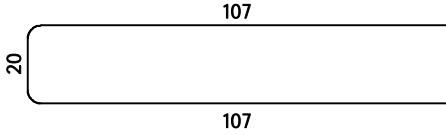
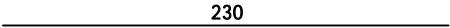
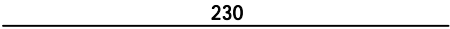
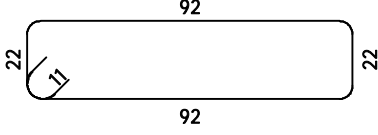
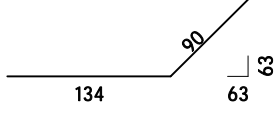
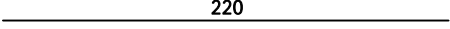
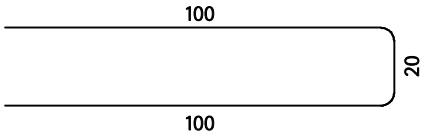
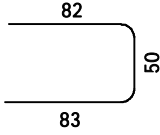
Šipke - specifikacija						
ozn	oblik i mjere [cm]	Ø	lg [m]	n [kom]	lgn [m]	Napomena
183		10	2.50	70	175.00	
184		10	2.50	57	142.50	
185		10	2.50	12	30.00	
186		10	2.66	8	21.28	
187		10	2.40	68	163.20	
188		10	2.40	116	278.40	
189		10	2.34	5	11.70	
190		10	2.30	136	312.80	
191		10	2.30	17	39.10	
192		10	2.50	28	70.00	
193		10	2.24	121	271.04	
194		10	2.20	76	167.20	
195		10	2.20	354	778.80	
196		10	2.15	10	21.50	



ISKAZ ARMATURE

GRAĐEVINA:	REKONSTRUKCIJA TERMALNOG REK. CENT. TERME TUHELJ	
ISKAZ UZ NACRT:	ARM-TK-2-301-308	
SADRŽAJ:	ARMATURA TEMELJA -2	
DATUM:	24/06/2023	12/23

Šipke - specifikacija						
ozn	oblik i mjere [cm]	Ø	lg [m]	n [kom]	lgn [m]	Napomena
197		10	2.11	28	59.08	
198		10	2.10	5	10.50	
199		10	2.10	16	33.60	
200		10	2.05	14	28.70	
201		10	2.04	8	16.32	
202		10	2.24	22	49.28	
203		10	2.00	283	566.00	
204		10	2.00	84	168.00	
205		10	2.00	3	6.00	
206		10	2.00	21	42.00	
207		10	2.00	109	218.00	
208		10	1.98	160	316.80	

ISKAZ ARMATURE

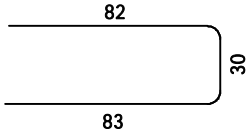
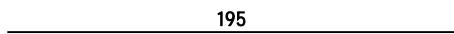
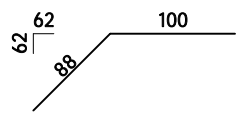
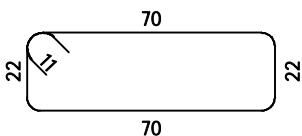
GRAĐEVINA:	REKONSTRUKCIJA TERMALNOG REK. CENT. TERME TUHELJ	
ISKAZ UZ NACRT:	ARM-TK-2-301-308	
SADRŽAJ:	ARMATURA TEMELJA -2	
DATUM:	24/06/2023	13/23

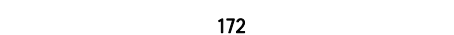
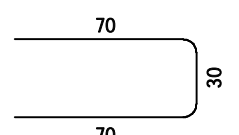
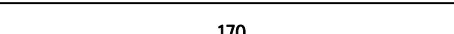
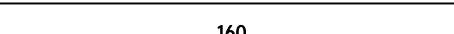
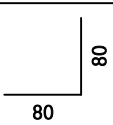
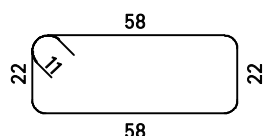
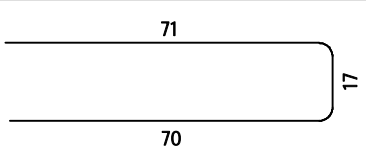
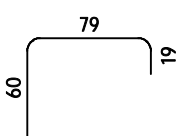
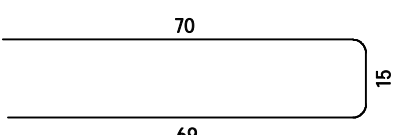
Šipke - specifikacija						
ozn	oblik i mjere [cm]	Ø	lg [m]	n [kom]	lgn [m]	Napomena
209		10	1.95	219	427.05	
210		10	1.95	13	25.35	
211		10	1.88	8	15.04	
212		10	2.06	28	57.68	
213		10	1.74	11	19.14	
214		10	1.72	14	24.08	
215		10	1.70	393	668.10	
216		10	1.70	24	40.80	
217		10	1.60	92	147.20	
218		10	1.60	4	6.40	
219		10	1.82	28	50.96	
220		10	1.58	11	17.38	
221		10	1.58	158	249.64	
222		10	1.54	793	1221.22	

ISKAZ ARMATURE		
GRAĐEVINA:	REKONSTRUKCIJA TERMALNOG REK. CENT. TERME TUHELJ	
ISKAZ UZ NACRT:	ARM-TK-2-301-308	
SADRŽAJ:	ARMATURA TEMELJA -2	
DATUM:	24/06/2023	14/23

Šipke - specifikacija						
ozn	oblik i mjere [cm]	Ø	lg [m]	n [kom]	lgn [m]	Napomena
223		10	1.50	21	31.50	
224		10	1.40	25	35.00	
225		10	1.33	1049	1395.17	
226		10	1.20	27	32.40	
227		10	1.20	8	9.60	
228		10	1.00	2160	2160.00	
229		10	1.00	290	290.00	
230		8	4.50	2	9.00	
231		8	4.15	2	8.30	
232		8	4.10	4	16.40	
233		8	4.04	2	8.08	
234		8	3.90	8	31.20	
235		8	3.70	4	14.80	
236		8	3.70	2	7.40	

ISKAZ ARMATURE

GRAĐEVINA:	REKONSTRUKCIJA TERMALNOG REK. CENT. TERME TUHELJ	
ISKAZ UZ NACRT:	ARM-TK-2-301-308	
SADRŽAJ:	ARMATURA TEMELJA -2	
DATUM:	24/06/2023	15/23

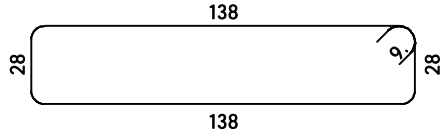
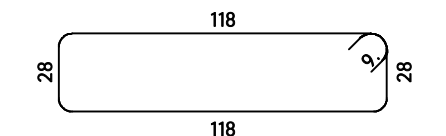
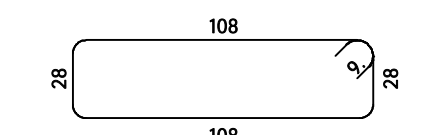
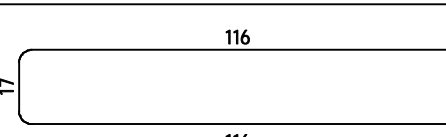
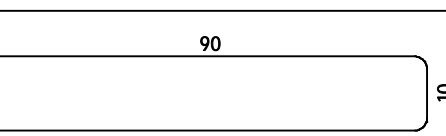
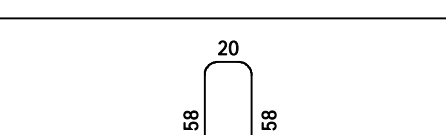
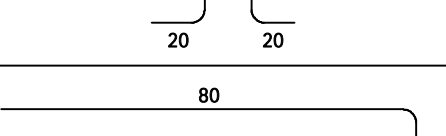
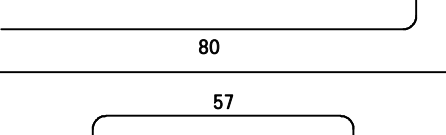
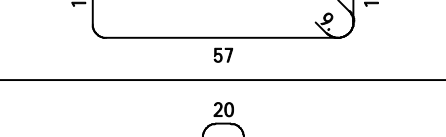
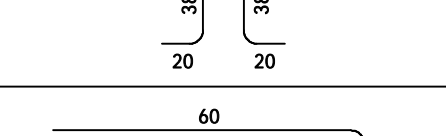
Šipke - specifikacija						
ozn	oblik i mjere [cm]	Ø	lg [m]	n [kom]	lgn [m]	Napomena
237		8	3.50	4	14.00	
238		8	3.10	2	6.20	
239		8	2.90	24	69.60	
240		8	2.49	1050	2614.50	
241		8	1.90	47	89.30	
242		8	1.76	240	422.40	
243		8	1.75	6	10.50	
244		8	1.66	30	49.80	
245		8	1.36	15	20.40	
246		8	1.35	2	2.70	

ISKAZ ARMATURE

GRAĐEVINA:	REKONSTRUKCIJA TERMALNOG REK. CENT. TERME TUHELJ	
ISKAZ UZ NACRT:	ARM-TK-2-301-308	
SADRŽAJ:	ARMATURA TEMELJA -2	
DATUM:	24/06/2023	16/23

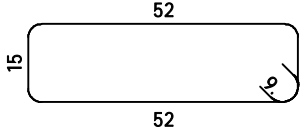
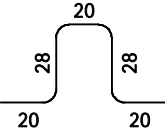
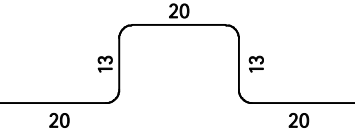
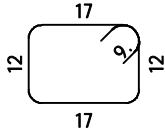
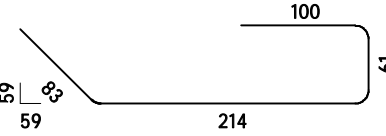
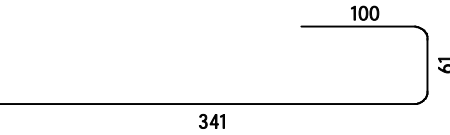
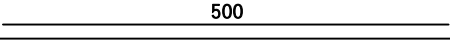
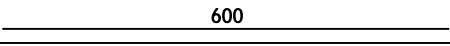
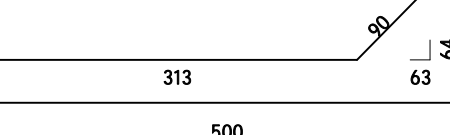
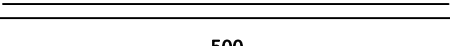
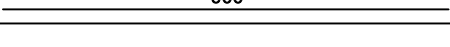
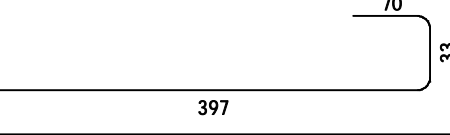
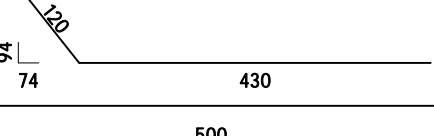
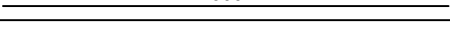
Šipke - specifikacija						
ozn	oblik i mjere [cm]	Ø	lg [m]	n [kom]	lgn [m]	Napomena
247		8	1.52	2	3.04	
248		8	1.16	2000	2320.00	
249		8	0.86	120	103.20	
250		8	0.76	10	7.60	
251		20	4.58	204	934.32	
252		20	5.02	29	145.58	
253		20	5.00	151	755.00	
254		20	6.00	108	648.00	
255		20	4.03	74	298.22	
256		20	5.00	62	310.00	
257		20	5.00	347	1735.00	
258		20	5.00	432	2160.00	
259		20	5.50	11	60.50	
260		20	5.00	52	260.00	

ISKAZ ARMATURE		
GRAĐEVINA:	REKONSTRUKCIJA TERMALNOG REK. CENT. TERME TUHELJ	
ISKAZ UZ NACRT:	ARM-TK-2-301-308	
SADRŽAJ:	ARMATURA TEMELJA -2	
DATUM:	24/06/2023	17/23

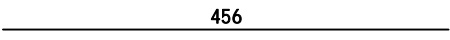
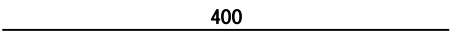
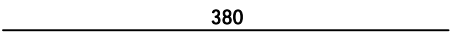
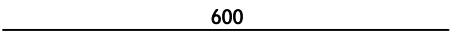
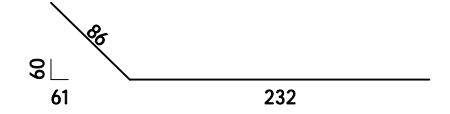
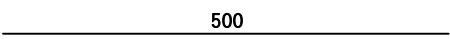
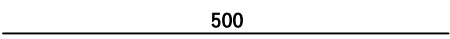
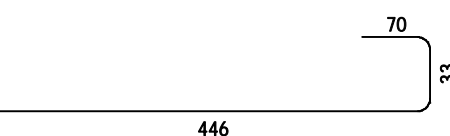
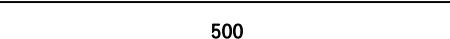
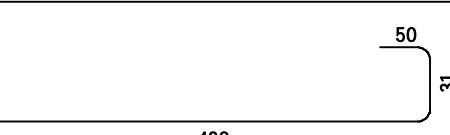
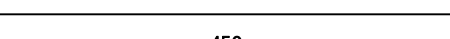
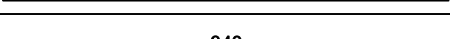
Šipke - specifikacija						
ozn	oblik i mjere [cm]	Ø	lg [m]	n [kom]	lgn [m]	Napomena
261		20	4.56	64	291.84	
262		20	4.00	10	40.00	
263		20	3.80	12	45.60	
264		20	6.00	80	480.00	
265		20	3.18	86	273.48	
266		20	5.00	168	840.00	
267		20	5.00	158	790.00	
268		20	5.49	67	367.83	
269		20	5.00	50	250.00	
270		20	5.19	24	124.56	
271		16	4.50	172	774.00	
272		10	2.40	3	7.20	

ISKAZ ARMATURE		
GRAĐEVINA:	REKONSTRUKCIJA TERMALNOG REK. CENT. TERME TUHELJ	
ISKAZ UZ NACRT:	ARM-TK-2-301-308	
SADRŽAJ:	ARMATURA TEMELJA -2	
DATUM:	24/06/2023	18/23

Šipke - rekapitulacija			
Ø [mm]	lgn [m]	Jedinična težina [kg/m ¹]	Težina [kg]
B500B			
8	5828.42	0.40	2302.23
10	26621.65	0.62	16425.56
12	0.00	0.89	0.00
14	3965.60	1.21	4798.38
16	799.82	1.58	1263.72
20	12130.43	2.47	29962.16
25	0.00	3.85	0.00
Ukupno (B500B)			54752.04
Ukupno			54752.04

ISKAZ ARMATURE		
GRAĐEVINA:	REKONSTRUKCIJA TERMALNOG REK. CENT. TERME TUHELJ	
ISKAZ UZ NACRT:	ARM-TK-2-301-308	
SADRŽAJ:	ARMATURA TEMELJA -2	
DATUM:	24/06/2023	19/23

Mreže - specifikacija							
Pozicija	Oznaka mreže	B [cm]	L [cm]	n	Jedinična težina [kg/m ²]	Ukupna težina [kg]	Napomena
TK-DIL 3 - 2 - TEMELJNA KONSTRUKCIJA - (1 kom)							
1	Q-524	215	600	34	8.31	3644.77	
1-1	Q-524	215	331	1	8.31	59.14	
1-2	Q-524	215	496	2	8.31	177.22	
1-3	Q-524	184	600	1	8.31	91.74	
1-4	Q-524	184	496	1	8.31	75.83	
1-5	Q-524	215	600	130	8.31	13935.87	
1-6	Q-524	215	410	1	8.31	73.27	
1-7	Q-524	215	411	1	8.31	73.43	
1-8	Q-524	215	412	1	8.31	73.60	
1-9	Q-524	215	413	1	8.31	73.76	
1-10	Q-524	215	414	1	8.31	73.92	
1-11	Q-524	215	415	1	8.31	74.09	
1-12	Q-524	215	416	1	8.31	74.25	
1-13	Q-524	215	600	1	8.31	107.11	
1-14	Q-524	215	537	1	8.31	95.92	
1-15	Q-524	215	419	1	8.31	74.94	
1-16	Q-524	95	293	1	8.31	23.18	
1-17	Q-524	183	498	1	8.31	75.57	
1-18	Q-524	126	343	1	8.31	35.88	
1-19	Q-524	179	548	1	8.31	81.40	
1-20	Q-524	202	545	1	8.31	91.47	
1-21	Q-524	202	211	1	8.31	35.35	
1-22	Q-524	215	392	1	8.31	70.04	
1-23	Q-524	215	483	1	8.31	86.34	
1-24	Q-524	150	416	1	8.31	51.79	
1-25	Q-524	215	307	1	8.31	54.92	
1-26	Q-524	201	600	1	8.31	100.20	
1-27	Q-524	215	599	1	8.31	107.05	
1-28	Q-524	77	458	1	8.31	29.22	
1-29	Q-524	215	145	1	8.31	25.82	
1-30	Q-524	215	292	1	8.31	52.25	
1-31	Q-524	215	145	1	8.31	25.93	
1-32	Q-524	215	146	1	8.31	26.03	
1-33	Q-524	215	146	1	8.31	26.13	
1-34	Q-524	215	147	1	8.31	26.23	
1-35	Q-524	215	147	1	8.31	26.34	
1-36	Q-524	215	148	1	8.31	26.44	

ISKAZ ARMATURE		
GRAĐEVINA:	REKONSTRUKCIJA TERMALNOG REK. CENT. TERME TUHELJ	
ISKAZ UZ NACRT:	ARM-TK-2-301-308	
SADRŽAJ:	ARMATURA TEMELJA -2	
DATUM:	24/06/2023	20/23

Mreže - specifikacija							
Pozicija	Oznaka mreže	B [cm]	L [cm]	n	Jedinična težina [kg/m ²]	Ukupna težina [kg]	Napomena
1-37	Q-524	215	149	1	8.31	26.54	
1-38	Q-524	215	149	1	8.31	26.64	
1-39	Q-524	97	149	1	8.31	12.00	
1-40	Q-524	151	600	1	8.31	75.35	
1-41	Q-524	215	298	1	8.31	53.23	
1-42	Q-524	215	403	1	8.31	72.07	
1-43	Q-524	215	509	1	8.31	90.91	
1-44	Q-524	215	59	1	8.31	10.60	
1-45	Q-524	215	165	1	8.31	29.44	
1-46	Q-524	215	270	1	8.31	48.29	
1-47	Q-524	215	376	1	8.31	67.13	
1-48	Q-524	215	481	1	8.31	85.97	
1-49	Q-524	215	587	1	8.31	104.82	
1-50	Q-524	215	124	1	8.31	22.17	
1-51	Q-524	215	146	1	8.31	26.01	
1-52	Q-524	215	258	1	8.31	46.17	
1-53	Q-524	126	346	1	8.31	36.21	
1-54	Q-524	215	154	1	8.31	27.49	
1-55	Q-524	215	83	1	8.31	14.83	
1-56	Q-524	210	466	1	8.31	81.36	
1-57	Q-524	213	169	1	8.31	29.81	
1-58	Q-524	215	108	1	8.31	19.36	
1-59	Q-524	102	541	1	8.31	45.82	
1-60	Q-524	215	460	10	8.31	821.88	
1-61	Q-524	45	460	1	8.31	17.20	
1-62	Q-524	215	518	2	8.31	185.15	
1-63	Q-524	215	582	2	8.31	208.14	
1-64	Q-524	215	92	2	8.31	32.82	
1-65	Q-524	214	81	2	8.31	28.79	
1-66	Q-524	170	427	1	8.31	60.28	
1-67	Q-524	153	153	2	8.31	39.06	
1-68	Q-524	184	368	2	8.31	112.72	
1-69	Q-524	144	315	1	8.31	37.76	
1-70	Q-524	204	494	1	8.31	83.79	
1-71	Q-524	215	485	1	8.31	86.70	
1-72	Q-524	215	506	2	8.31	180.88	
1-73	Q-524	164	600	1	8.31	81.87	
1-74	Q-524	164	506	1	8.31	69.07	

ISKAZ ARMATURE		
GRAĐEVINA:	REKONSTRUKCIJA TERMALNOG REK. CENT. TERME TUHELJ	
ISKAZ UZ NACRT:	ARM-TK-2-301-308	
SADRŽAJ:	ARMATURA TEMELJA -2	
DATUM:	24/06/2023	21/23

Mreže - specifikacija							
Pozicija	Oznaka mreže	B [cm]	L [cm]	n	Jedinična težina [kg/m ²]	Ukupna težina [kg]	Napomena
1-75	Q-524	215	202	1	8.31	36.08	
1-76	Q-524	215	165	1	8.31	29.46	
1-77	Q-524	215	273	1	8.31	48.81	
1-78	Q-524	215	153	1	8.31	27.38	
1-79	Q-524	203	600	1	8.31	101.02	
1-80	Q-524	215	272	1	8.31	48.59	
1-81	Q-524	215	153	1	8.31	27.38	
1-82	Q-524	215	271	1	8.31	48.36	
1-83	Q-524	215	151	1	8.31	27.03	
1-84	Q-524	215	269	1	8.31	48.14	
1-85	Q-524	125	525	1	8.31	54.41	
1-86	Q-524	125	600	1	8.31	62.21	
1-87	Q-524	72	89	1	8.31	5.37	
1-88	Q-524	215	268	1	8.31	47.92	
1-89	Q-524	72	224	1	8.31	13.45	
1-90	Q-524	83	93	1	8.31	6.39	
1-91	Q-524	83	600	1	8.31	41.38	
1-92	Q-524	215	333	1	8.31	59.50	
1-93	Q-524	215	549	1	8.31	98.15	
1-94	Q-524	215	473	1	8.31	84.54	
1-95	Q-524	215	487	1	8.31	87.10	
1-96	Q-524	203	172	1	8.31	28.98	
1-97	Q-524	215	426	1	8.31	76.04	
1-98	Q-524	215	535	1	8.31	95.59	
1-99	Q-524	80	491	1	8.31	32.54	
1-100	Q-524	215	315	1	8.31	56.36	
1-101	Q-524	118	291	1	8.31	28.53	
1-102	Q-524	215	560	1	8.31	100.07	
1-103	Q-524	215	459	1	8.31	82.04	
1-104	Q-524	215	60	1	8.31	10.73	
1-105	Q-524	215	570	1	8.31	101.84	
1-106	Q-524	128	350	1	8.31	37.15	
1-107	Q-524	215	574	1	8.31	102.64	
1-108	Q-524	215	564	1	8.31	100.77	
1-109	Q-524	185	102	1	8.31	15.72	
1-110	Q-524	137	377	1	8.31	42.88	
1-111	Q-524	215	207	1	8.31	37.06	
1-112	Q-524	215	291	1	8.31	51.98	

ISKAZ ARMATURE		
GRAĐEVINA:	REKONSTRUKCIJA TERMALNOG REK. CENT. TERME TUHELJ	
ISKAZ UZ NACRT:	ARM-TK-2-301-308	
SADRŽAJ:	ARMATURA TEMELJA -2	
DATUM:	24/06/2023	22/23

Mreže - specifikacija							
Pozicija	Oznaka mreže	B [cm]	L [cm]	n	Jedinična težina [kg/m ²]	Ukupna težina [kg]	Napomena
1-113	Q-524	215	317	1	8.31	56.66	
1-114	Q-524	215	292	1	8.31	52.18	
1-115	Q-524	215	484	1	8.31	86.48	
1-116	Q-524	215	293	1	8.31	52.38	
1-117	Q-524	215	299	1	8.31	53.40	
1-118	Q-524	215	258	1	8.31	46.14	
1-119	Q-524	215	294	1	8.31	52.58	
1-120	Q-524	215	261	1	8.31	46.71	
1-121	Q-524	215	258	1	8.31	46.11	
1-122	Q-524	215	295	1	8.31	52.79	
1-123	Q-524	215	224	1	8.31	40.02	
1-124	Q-524	215	258	1	8.31	46.07	
1-125	Q-524	215	297	1	8.31	52.99	
1-126	Q-524	215	187	1	8.31	33.32	
1-127	Q-524	215	258	1	8.31	46.04	
1-128	Q-524	215	501	1	8.31	89.52	
1-129	Q-524	101	104	1	8.31	8.73	
1-130	Q-524	215	248	1	8.31	44.37	
1-131	Q-524	174	446	1	8.31	64.33	
1-132	Q-524	138	142	1	8.31	16.32	
1-133	Q-524	102	263	1	8.31	22.38	
1-134	Q-524	215	407	1	8.31	72.73	
1-135	Q-524	215	517	1	8.31	92.45	
1-136	Q-524	124	77	1	8.31	7.97	
1-137	Q-524	215	453	1	8.31	80.96	
1-138	Q-524	156	303	1	8.31	39.33	
1-139	Q-524	215	389	1	8.31	69.47	
1-140	Q-524	215	566	1	8.31	101.05	
1-141	Q-524	215	107	1	8.31	19.20	
1-142	Q-524	215	204	1	8.31	36.51	
1-143	Q-524	112	301	1	8.31	27.99	
1-144	Q-524	143	333	1	8.31	39.57	
1-145	Q-524	179	600	2	8.31	178.33	
1-146	Q-524	179	600	2	8.31	178.36	
1-147	Q-524	179	600	2	8.31	178.39	
1-148	Q-524	179	600	2	8.31	178.42	
1-149	Q-524	179	600	2	8.31	178.45	
1-150	Q-524	179	600	2	8.31	178.48	

ISKAZ ARMATURE		
GRAĐEVINA:	REKONSTRUKCIJA TERMALNOG REK. CENT. TERME TUHELJ	
ISKAZ UZ NACRT:	ARM-TK-2-301-308	
SADRŽAJ:	ARMATURA TEMELJA -2	
DATUM:	24/06/2023	23/23

Mreže - specifikacija							
Pozicija	Oznaka mreže	B [cm]	L [cm]	n	Jedinična težina [kg/m2]	Ukupna težina [kg]	Napomena
1-151	Q-524	179	600	2	8.31	178.51	
1-152	Q-524	179	445	2	8.31	132.35	
1-153	Q-524	215	167	1	8.31	29.77	
1-154	Q-524	215	171	1	8.31	30.49	
1-155	Q-524	160	172	1	8.31	22.85	
1-156	Q-524	194	527	1	8.31	85.10	
1-157	Q-524	170	488	1	8.31	68.90	
1-158	Q-524	215	410	1	8.31	73.22	
1-159	Q-524	215	455	2	8.31	162.52	
1-160	Q-524	110	74	1	8.31	6.79	
1-161	Q-524	215	586	1	8.31	104.62	
1-162	Q-524	215	542	1	8.31	96.82	
1-163	Q-524	215	414	1	8.31	73.90	
1-164	Q-524	215	308	1	8.31	55.04	
1-165	Q-524	170	203	1	8.31	28.65	
Ukupno						28775.04	

NACRT SAVIJANJA ARMATURE FONTANE, MJ.1:50
TLOCRT TEMELJNE PLOČE

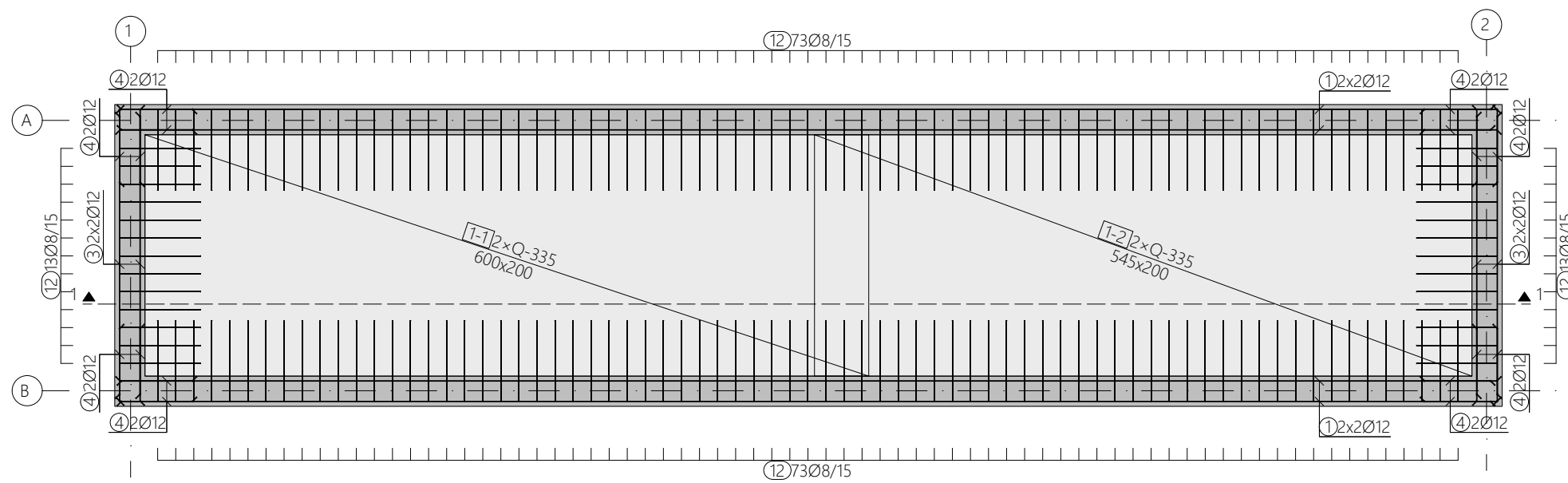

POGLED NA ZID U OSI A

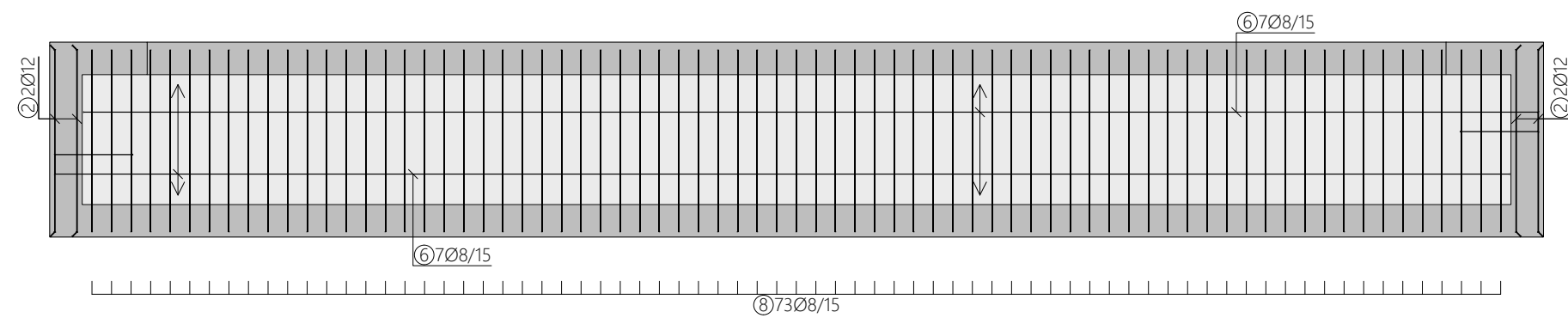

POGLED NA ZID U OSI B

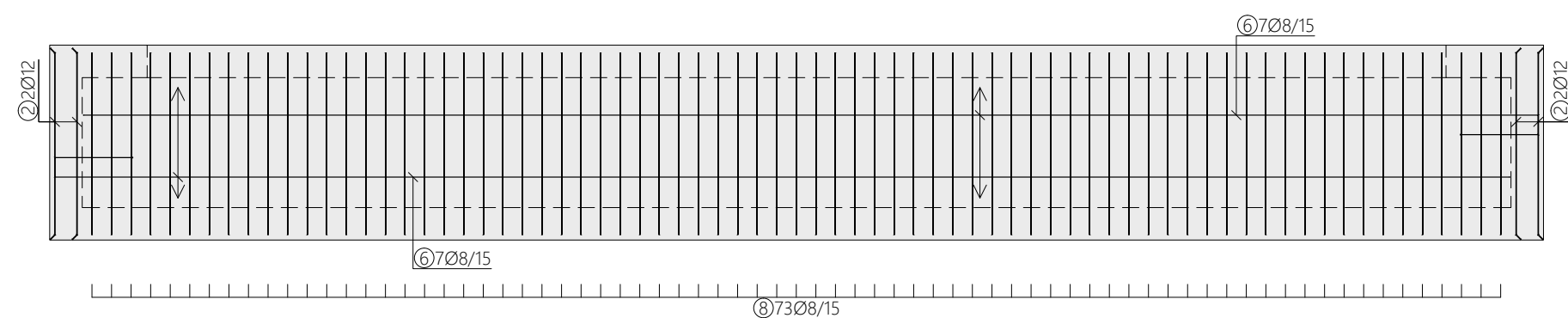

POGLED NA ZID U OSI 1

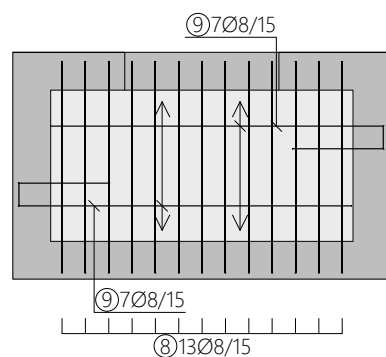

POGLED NA ZID U OSI 2

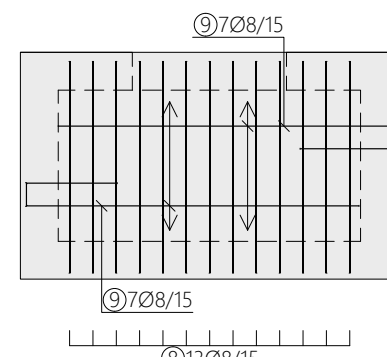

TLOCRT STROPNE PLOČE

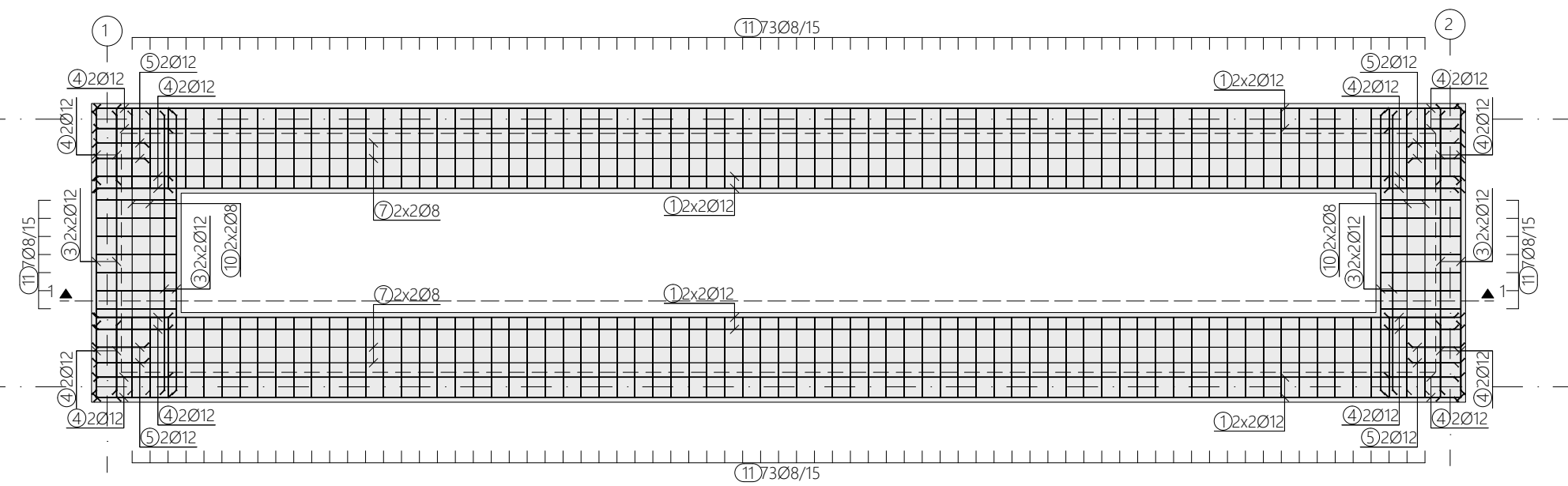

Šipke - specifikacija					
ozn	oblik i mjere [cm]	Ø	lg [m]	n [kom]	lgn [m]
fontana (1 kom)					
1	1135	12	11.35	24	272.40
2	140	12	3.40	8	27.20
	140				
3	230	12	2.30	24	55.20
4	65	12	1.45	40	58.00
	65				
5	45	12	1.05	8	8.40
	45				
6	60	8	11.95	28	334.60
	1120				
7	1135	8	11.35	8	90.80
8	140	8	3.32	172	571.04
	140				
9	60	8	2.95	28	82.60
	220				
10	230	8	2.30	8	18.40
11	67	8	1.86	160	297.60
	67				
12	65	8	1.45	172	249.40
	65				
13	25	8	1.01	44	44.44
	25				

Šipke - rekapitulacija			
Ø [mm]	lgn [m]	Jedinična težina [kg/m³]	Težina [kg]
B500B			
8	1688.88	0.40	667.11
10	0.00	0.62	0.00
12	421.20	0.89	374.03
Ukupno (B500B)			1041.13
Ukupno			1041.13

Mreže - specifikacija						
pozicija	Oznaka mreže	B [cm]	L [cm]	n	Jedinična težina [kg/m²]	Ukupna težina [kg]
fontana (1 kom)						
1-1	Q-335	200	600	2	5.38	129.12
1-2	Q-335	200	545	2	5.38	117.28
Ukupno						246.40

JAHAČI - 2 KOM / m2
PLOČA d=25 cm

NAPOMENA
Šipke prilagoditi i po potrebi rezati na licu mjesta. Preklap 50Ø.

NAPOMENA
Sve dimenzije provjeriti prema važećim planovima oplata.

Klasa betona	C 25/30
Armatura	B 500 B
Zaštitni sloj betona podzemnih zidova	
obostrano	Pripadajuća lista armature : ARM_TK-2_321-322_ISKAZ
4,0 cm	
Zaštitni sloj betona nadzemnih zidova	
obostrano	
3,0 cm	
Pripadajući armaturni nacrti	
ARM_TK-2_322	

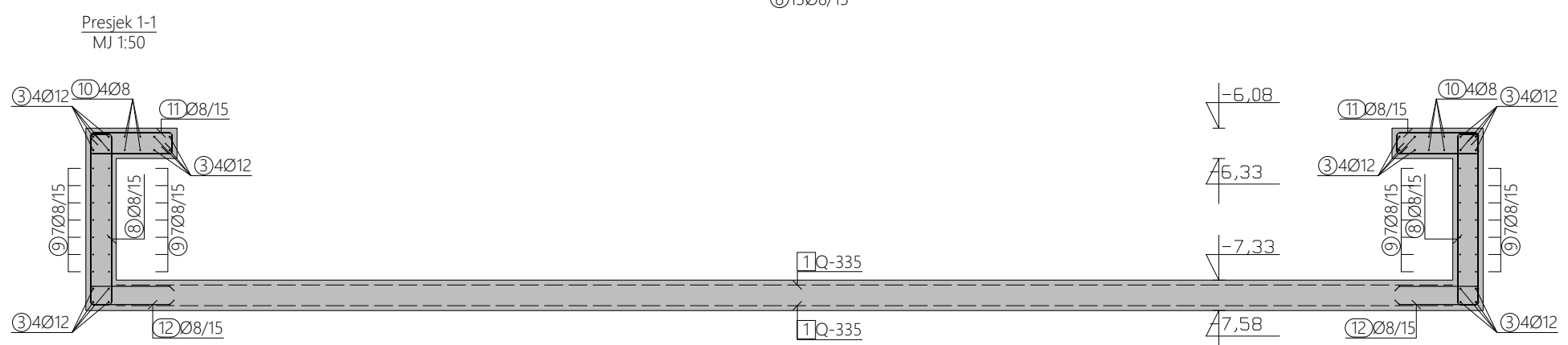

KONSTRUKTA
KONSTRUKTA d.o.o., za projektiranje i nadzor
Desinička 20, ZAGREB, OIB: 06674378579
ŽR: PRIVREDNA BANKA 2340009-1110164468
TEL: 01/36 43 828; FAX: 01/36 43 829
MAIL: info@konstrukta.hr

PEČAT I POTPIS:
Hrvatska Komora Inženjera Građevinarstva
Antonio Maglov
dipl. ing. građ.
Ovlašten inženjer građevinarstva
G 3775

INVESTITOR:	TERME TUHELJ d.o.o. Ljudevita Gaja 4, Tuhejske Toplice, 49215 Tuhej	GL. PROJEKTANT:	Tomislav Vreš, dipl. ing. arh.
GRAĐEVINA:	REKONSTRUKCIJA TERMALNOG REKREACUSKOG CENTRA TERME TUHELJ	PROJEKT. IZV. PR:	Antonio Maglov, dipl. ing. grad.
LOKACIJA:	na k.č.br. 3199/1, k.o. Črešnjevec	IZRADIO:	Antonio Maglov, dipl. ing. grad.
FAZA:	IZVEDBENI PROJEKT - ARMATURNI NACRTI	DATUM:	svibanj 2023.
SADRŽAJ:	ELEMENT - DILATACIJA 3 ARMATURA FONTANE	MJERILO:	1:50
		REVIZIJA:	00
		NACRT BR:	ARM - TK-2_321

NACRT SAVIJANJA ARMATURE STROJARNICE FONTANE, MJ.1:50
OSNOVNA ARMATURA TEMELJNE PLOČE

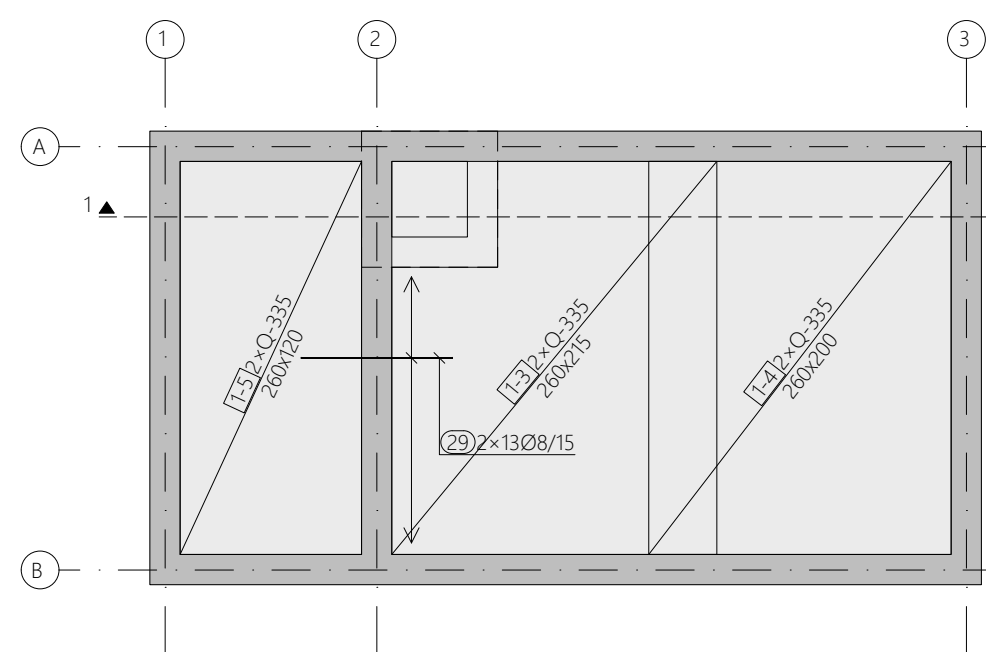

RUBNA ARMATURA TEMELJNE PLOČE

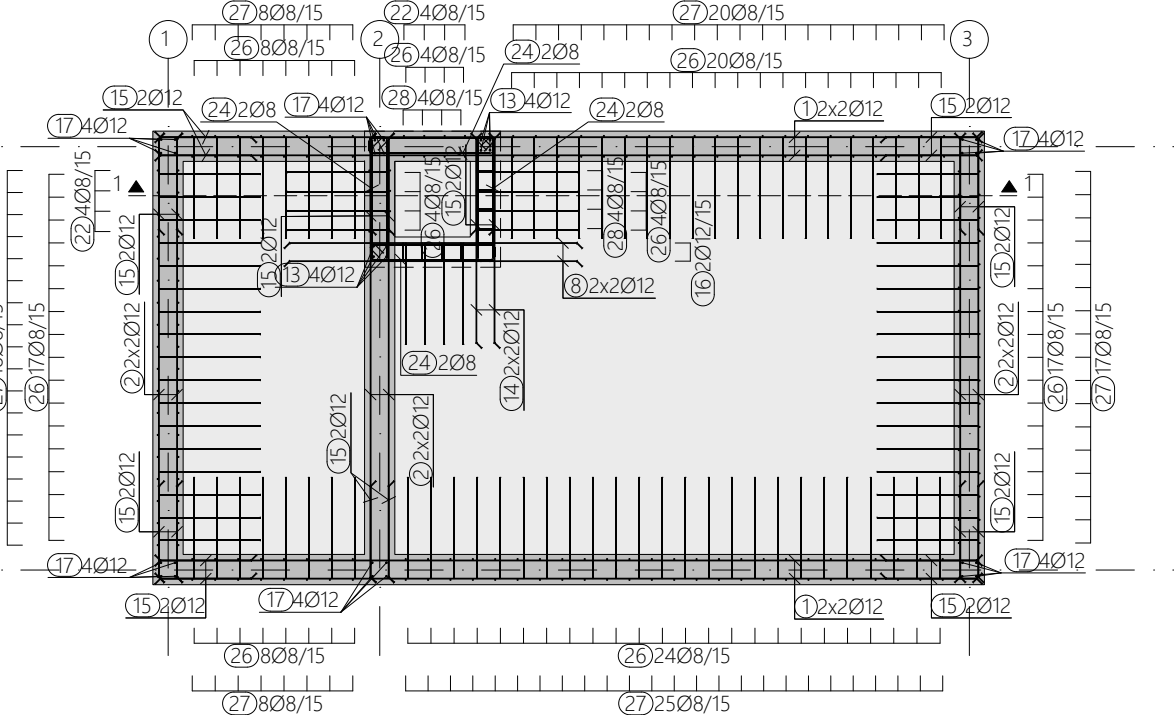

OSNOVNA ARMATURA STROPNE PLOČE

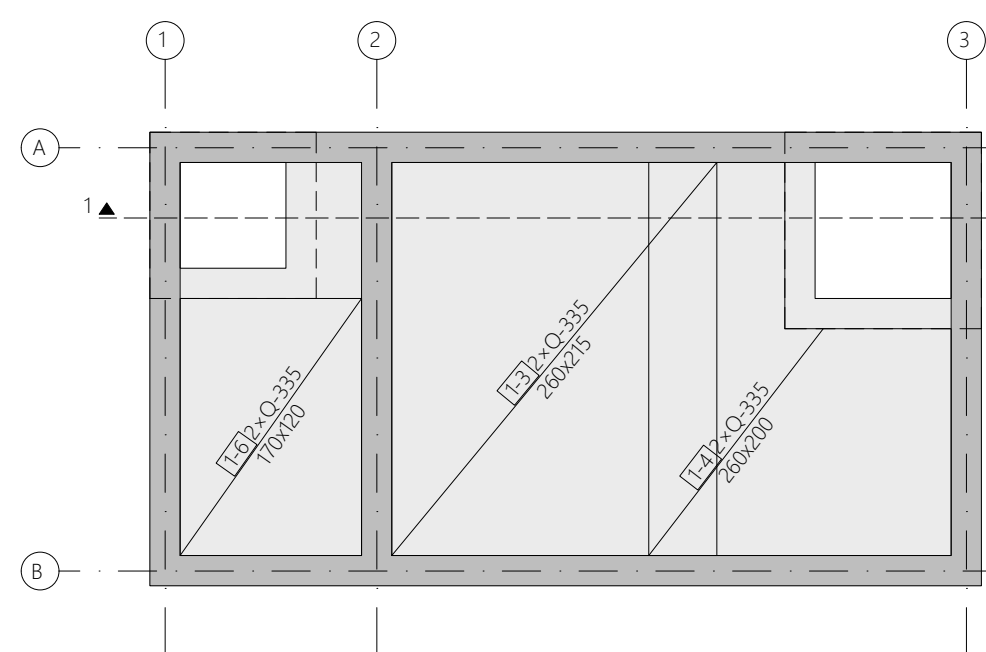

RUBNA ARMATURA STROPNE PLOČE

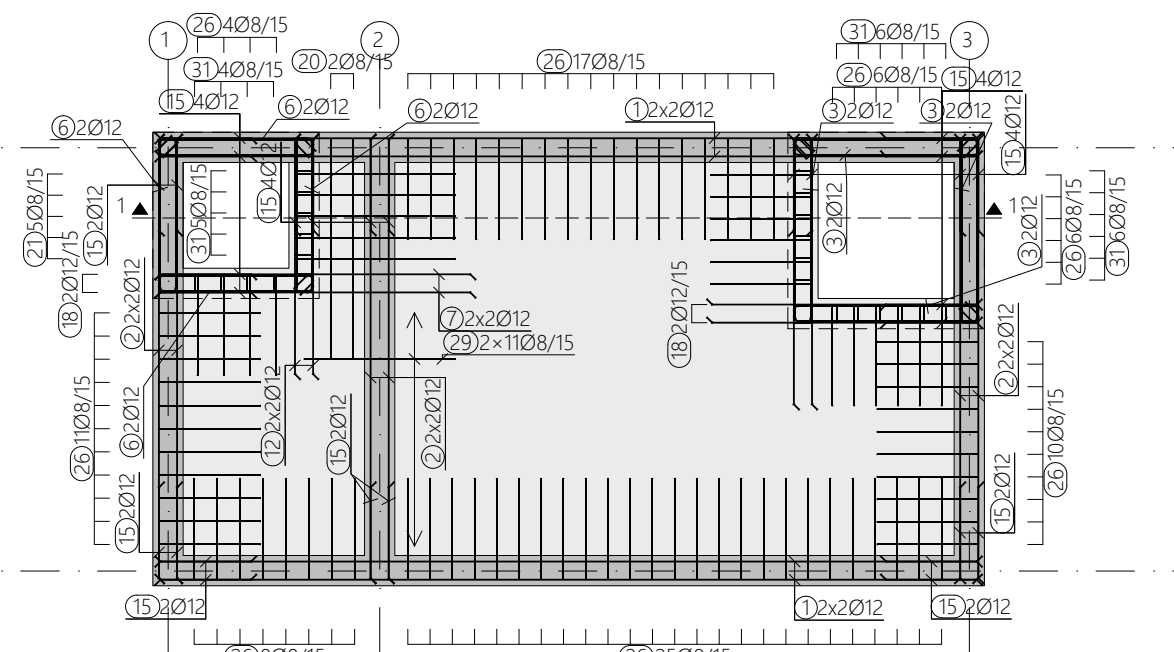

Šipke - specifikacija

ozn	oblik i mjere [cm]	Ø	lg [m]	n [kom]	lg _n [m]
strojarnica (1 kom)					
1	540	12	5.40	16	86.40
2	290	12	2.90	24	69.60
3	122	12	2.90	8	23.20
4	240	12	2.40	8	19.20
5	225	12	2.25	16	36.00
6	102	12	2.50	8	20.00
7	102	12	2.05	4	8.20
8	190	12	1.90	4	7.60
9	82	12	2.14	4	8.56
10	82	12	2.10	4	8.40
11	175	12	1.75	8	14.00
12	155	12	1.55	4	6.20
13	118	12	1.50	8	12.00
14	135	12	1.35	4	5.40
15	60	12	1.30	62	80.60
16	50	12	1.50	2	3.00

17	78	12	1.10	24	26.40
18	26	12	1.02	4	4.08
19	26	10	0.60	40	24.00
20	145	8	3.00	2	6.00
21	105	8	2.20	5	11.00
22	96	8	2.05	8	16.40
23	82	8	2.06	3	6.18
24	82	8	2.02	11	22.22
25	75	8	1.60	28	44.80
26	65	8	1.40	425	595.00
27	57	8	1.25	96	120.00

Mreže - specifikacija

pozicija	Oznaka mreže	B [cm]	L [cm]	n	Jedinična težina [kg/m ²]	Ukupna težina [kg]
strojarnica (1 kom)						
1-3	Q-335	215	260	4	5.38	120.30
1-4	Q-335	200	260	4	5.38	111.90
1-5	Q-335	120	260	2	5.38	33.57
1-6	Q-335	120	170	2	5.38	21.95
2-8	Q-335	90	210	6	5.38	61.01
2-9	Q-335	215	210	9	5.38	218.62
2-11	Q-335	120	210	4	5.38	54.23
2-12	Q-335	200	210	3	5.38	67.79
Ukupno						689.37

Šipke - rekapitulacija

Ø [mm]	lg _n [m]	Jedinična težina [kg/m]	Težina [kg]
B500B			
8	1022.56	0.40	403.91
10	24.00	0.62	14.81
12	438.84	0.89	389.69
Ukupno (B500B)			808.41
Ukupno			808.41

NAPOMENA
Šipke prilagoditi i po potrebi rezati na licu mjesta. Preklap 50Ø.

NAPOMENA
Sve dimenzije provjeriti prema važećim planovima opte.

JAHAČI - 2 KOM / m²

PLOČA d=20 cm

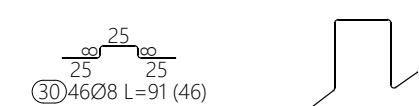

DETALJ POSTAVLJANJA DISTANCERA U ZIDOVE STROJARNICE

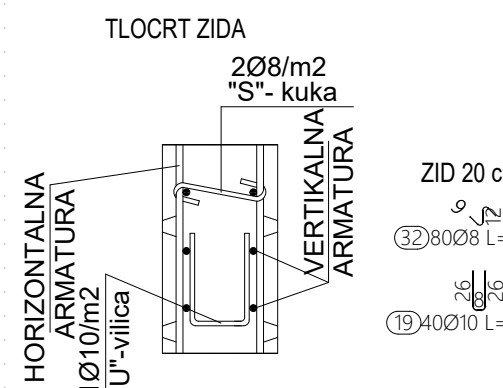

DETALJ UDUBLJENJA TEMELJNE PLOČE

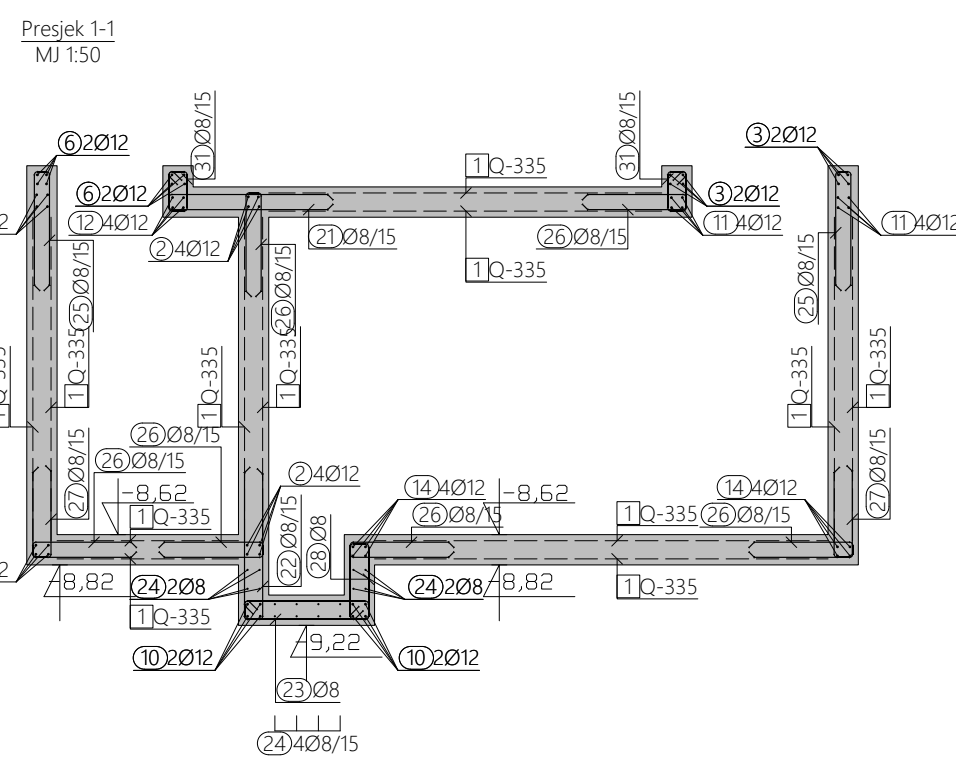
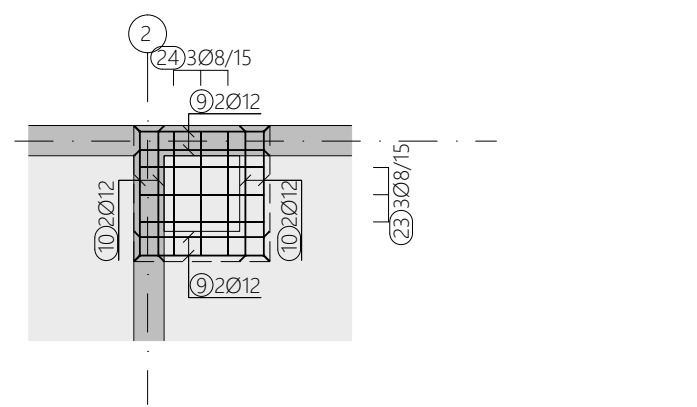

POGLED NA ZID U OSI 1

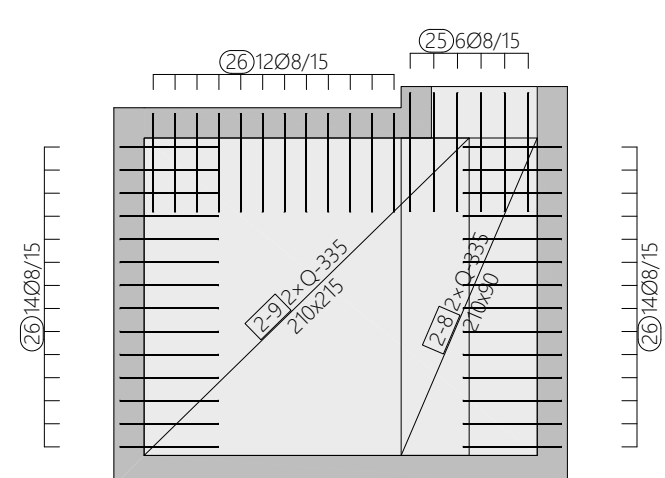

POGLED NA ZID U OSI 2

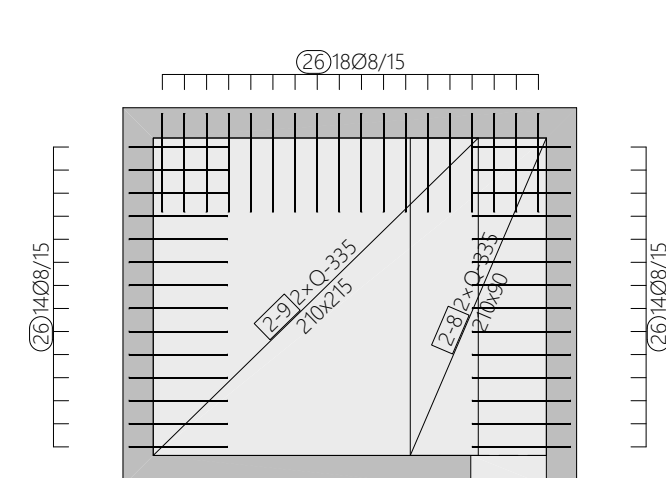

POGLED NA ZID U OSI 3

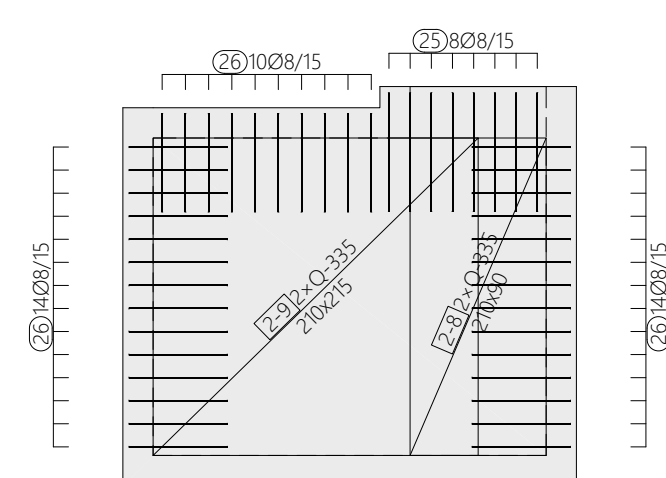

POGLED NA ZID U OSI A

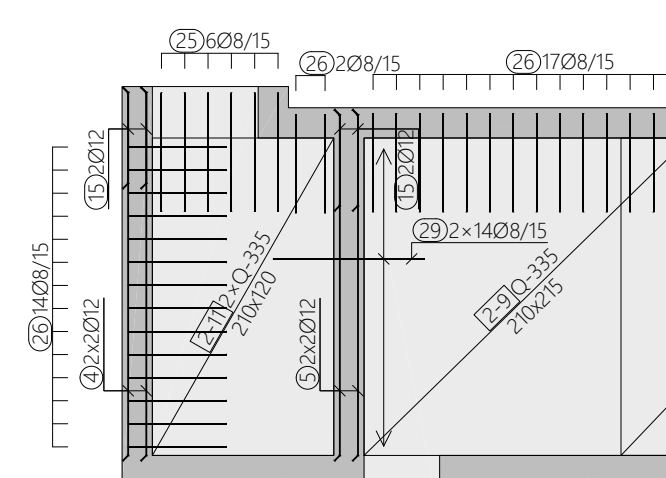

POGLED NA ZID U OSI B

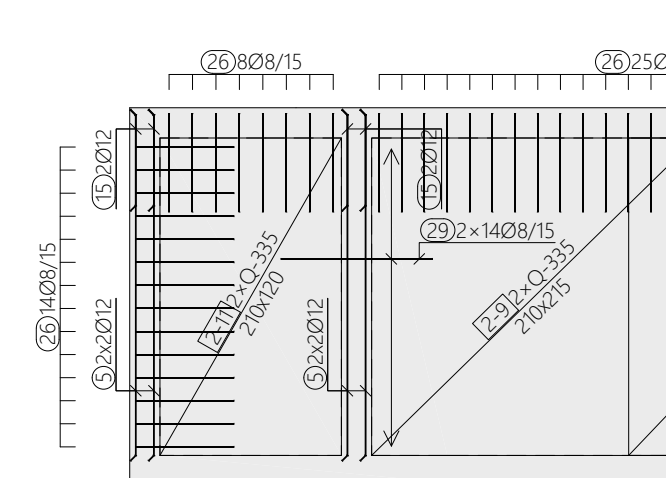

KONSTRUKTA





KONSTRUKTA d.o.o., za projektiranje i nadzor
Desinička 20, ZAGREB, OIB: 06674378579
ŽR: PRIVREDNA BANKA 2340009-1110164468
TEL: 01/36 43 828; FAX: 01/36 43 829
MAIL: info@konstrukta.hr

PEČAT I POTPIS:

Hrvatska Komora Inženjera Građevinarstva
Antonio Maglov, dipl. ing. grad.
Ovlašten inženjer građevinarstva G 3775

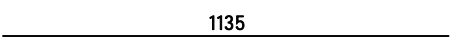
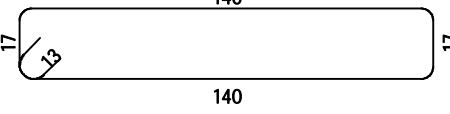
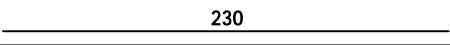
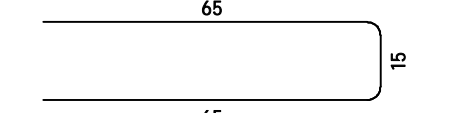
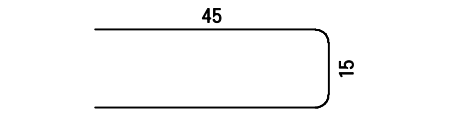
INVESTITOR:	TERME TUHELJ, d.o.o. Ljudevita Gaja 4, Tuhejske Toplice, 49215 Tuhej	GL. PROJEKTANT:	Tomislav Vreš, dipl. ing. arh.
GRADEVINA:	REKONSTRUKCIJA TERMALNOG REKREACIJSKOG CENTRA TERME TUHELJ	PROJEKT. IZV. PR:	Antonio Maglov, dipl. ing. grad.
LOKACIJA:	na k.č.br. 3199/1, k.o. Črešnjevac	IZRADIO:	Antonio Maglov, dipl. ing. grad.
FAZA:	IZVEDBENI PROJEKT - ARMATURNI NACRTI	DATUM:	svibanj 2023.
SADRŽAJ:	ELEMENT - DILATACIJA 3 ARMATURA STROJARNICE FONTANE	MJERILO:	1:50
		REVIZIJA:	00
		NACRT BR.:	ARM - TK-2-322

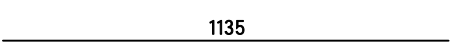
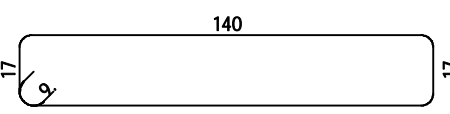

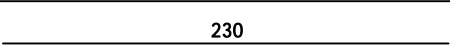
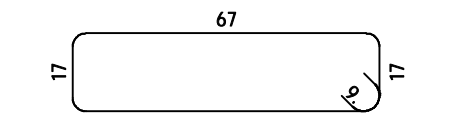
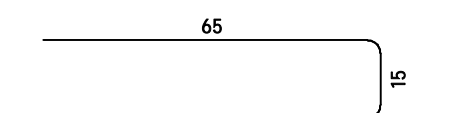
ISKAZ ARMATURE		
GRAĐEVINA:	REKONSTRUKCIJA TERMALNOG REKREACIJSKOG CENTRA TERME TUHELJ	
ISKAZ UZ NACRT:	ARM-E-2_321-322	
SADRŽAJ:	ARMATURA FONTANE I STROJARNICE FONTANE	
DATUM:	17/05/2023	1/6

Šipke - specifikacija						
ozn	oblik i mjere [cm]	Ø	lg [m]	n [kom]	lgn [m]	Napomena
fontana (1 kom)						
1		12	11.35	24	272.40	
2		12	3.40	8	27.20	
3		12	2.30	24	55.20	
4		12	1.45	40	58.00	
5		12	1.05	8	8.40	
6		8	11.95	28	334.60	
7		8	11.35	8	90.80	
8		8	3.32	172	571.04	
9		8	2.95	28	82.60	
10		8	2.30	8	18.40	
11		8	1.86	160	297.60	
12		8	1.45	172	249.40	

ISKAZ ARMATURE

GRAĐEVINA:	REKONSTRUKCIJA TERMALNOG REKREACIJSKOG CENTRA TERME TUHELJ	
ISKAZ UZ NACRT:	ARM-E-2_321-322	
SADRŽAJ:	ARMATURA FONTANE I STROJARNICE FONTANE	
DATUM:	17/05/2023	2/6

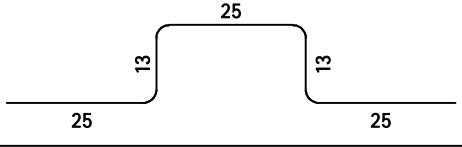
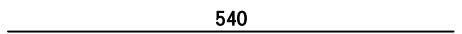
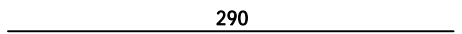
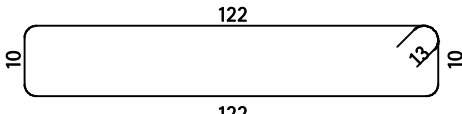
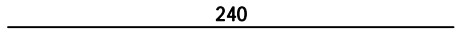
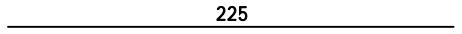
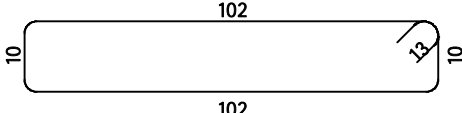
Šipke - specifikacija

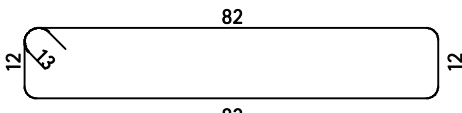
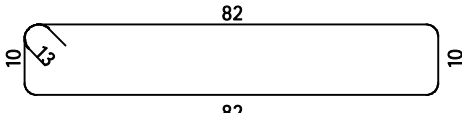
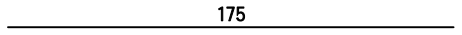
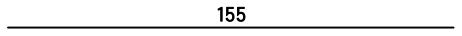
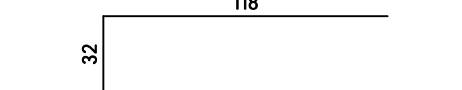
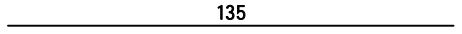
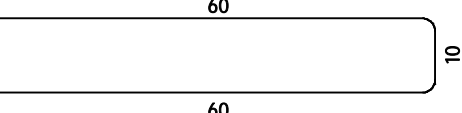
ozn	oblik i mjere [cm]	Ø	lg [m]	n [kom]	lgn [m]	Napomena
13		8	1.01	44	44.44	
strojarnica (1 kom)						
1		12	5.40	16	86.40	
2		12	2.90	24	69.60	
3		12	2.90	8	23.20	
4		12	2.40	8	19.20	
5		12	2.25	16	36.00	
6		12	2.50	8	20.00	
7		12	2.05	4	8.20	
8		12	1.90	4	7.60	
9		12	2.14	4	8.56	
10		12	2.10	4	8.40	
11		12	1.75	8	14.00	
12		12	1.55	4	6.20	
13		12	1.50	8	12.00	
14		12	1.35	4	5.40	
15		12	1.30	62	80.60	

ISKAZ ARMATURE

GRAĐEVINA:	REKONSTRUKCIJA TERMALNOG REKREACIJSKOG CENTRA TERME TUHELJ	
ISKAZ UZ NACRT:	ARM-E-2_321-322	
SADRŽAJ:	ARMATURA FONTANE I STROJARNICE FONTANE	
DATUM:	17/05/2023	3/6

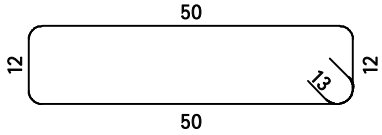
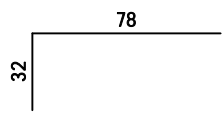
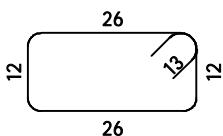
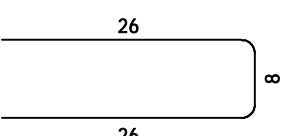
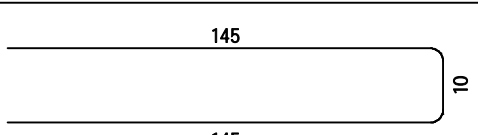
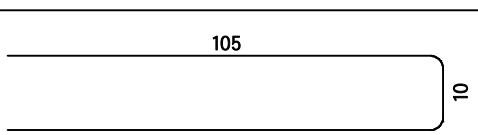
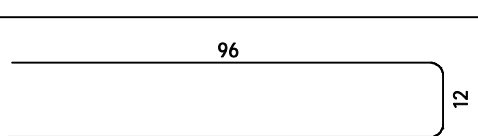
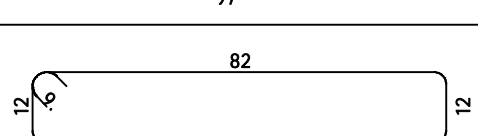
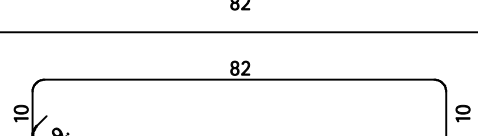
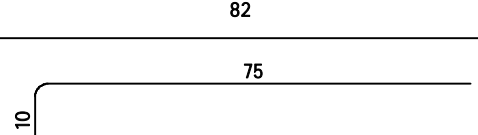
Šipke - specifikacija						
ozn	oblik i mjere [cm]	Ø	lg [m]	n [kom]	lgn [m]	Napomena
16		12	1.50	2	3.00	
17		12	1.10	24	26.40	
18		12	1.02	4	4.08	
19		10	0.60	40	24.00	
20		8	3.00	2	6.00	
21		8	2.20	5	11.00	
22		8	2.05	8	16.40	
23		8	2.06	3	6.18	
24		8	2.02	11	22.22	
25		8	1.60	28	44.80	

ISKAZ ARMATURE

GRAĐEVINA:	REKONSTRUKCIJA TERMALNOG REKREACIJSKOG CENTRA TERME TUHELJ	
ISKAZ UZ NACRT:	ARM-E-2_321-322	
SADRŽAJ:	ARMATURA FONTANE I STROJARNICE FONTANE	
DATUM:	17/05/2023	4/6

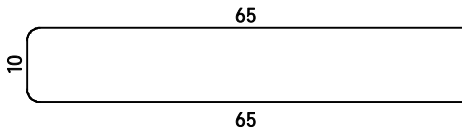
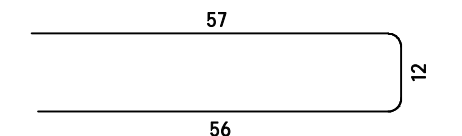
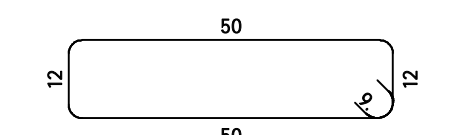
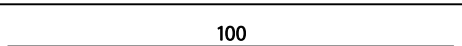
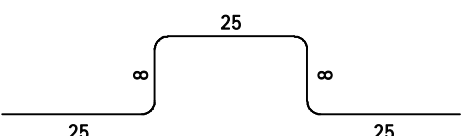
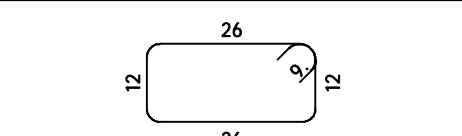
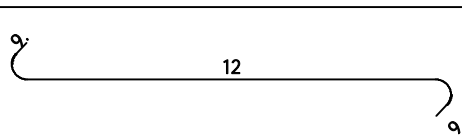
Šipke - specifikacija						
ozn	oblik i mjere [cm]	Ø	lg [m]	n [kom]	lgn [m]	Napomena
26		8	1.40	425	595.00	
27		8	1.25	96	120.00	
28		8	1.42	8	11.36	
29		8	1.00	104	104.00	
30		8	0.91	46	41.86	
31		8	0.94	21	19.74	
32		8	0.30	80	24.00	

ISKAZ ARMATURE		
GRAĐEVINA:	REKONSTRUKCIJA TERMALNOG REKREACIJSKOG CENTRA TERME TUHELJ	
ISKAZ UZ NACRT:	ARM-E-2_321-322	
SADRŽAJ:	ARMATURA FONTANE I STROJARNICE FONTANE	
DATUM:	17/05/2023	5/6

Šipke - rekapitulacija			
Ø [mm]	lgn [m]	Jedinična težina [kg/m ¹]	Težina [kg]
B500B			
8	2711.44	0.40	1071.02
10	24.00	0.62	14.81
12	860.04	0.89	763.72
Ukupno (B500B)			1849.54
Ukupno			1849.54

ISKAZ ARMATURE		
GRAĐEVINA:	REKONSTRUKCIJA TERMALNOG REKREACIJSKOG CENTRA TERME TUHELJ	
ISKAZ UZ NACRT:	ARM-E-2_321-322	
SADRŽAJ:	ARMATURA FONTANE I STROJARNICE FONTANE	
DATUM:	17/05/2023	6/6

Mreže - specifikacija							
Pozicija	Oznaka mreže	B [cm]	L [cm]	n	Jedinična težina [kg/m ²]	Ukupna težina [kg]	Napomena
fontana (1 kom)							
1-1	Q-335	200	600	2	5.38	129.12	
1-2	Q-335	200	545	2	5.38	117.28	
Ukupno						246.40	
strojarnica (1 kom)							
1-3	Q-335	215	260	4	5.38	120.30	
1-4	Q-335	200	260	4	5.38	111.90	
1-5	Q-335	120	260	2	5.38	33.57	
1-6	Q-335	120	170	2	5.38	21.95	
2-8	Q-335	90	210	6	5.38	61.01	
2-9	Q-335	215	210	9	5.38	218.62	
2-11	Q-335	120	210	4	5.38	54.23	
2-12	Q-335	200	210	3	5.38	67.79	
Ukupno						689.37	

NACRT SAVIJANJA ARMATURE DIZALA, DILATACIJA 3

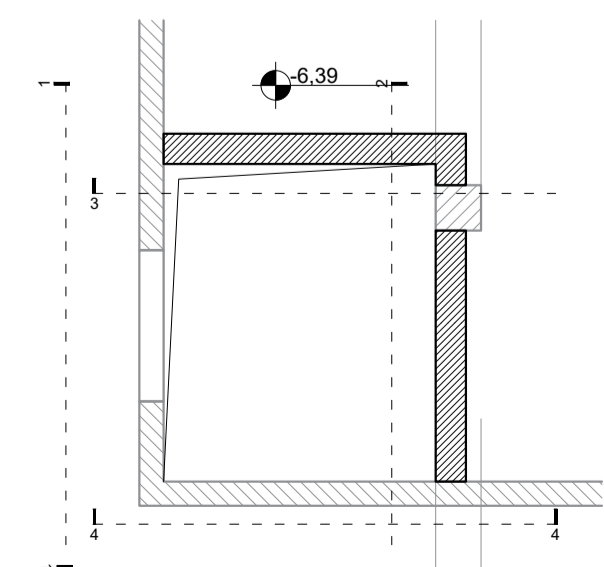
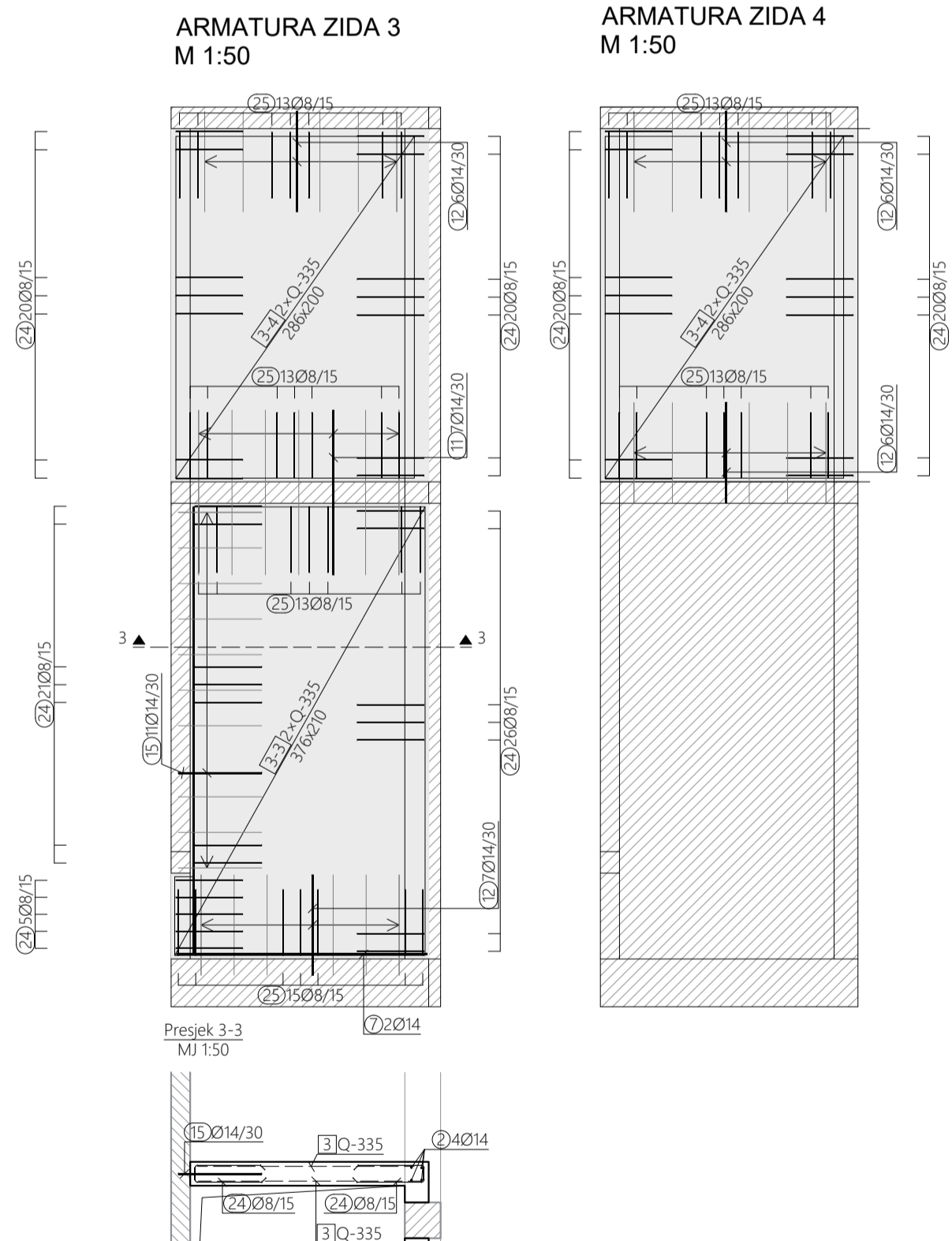
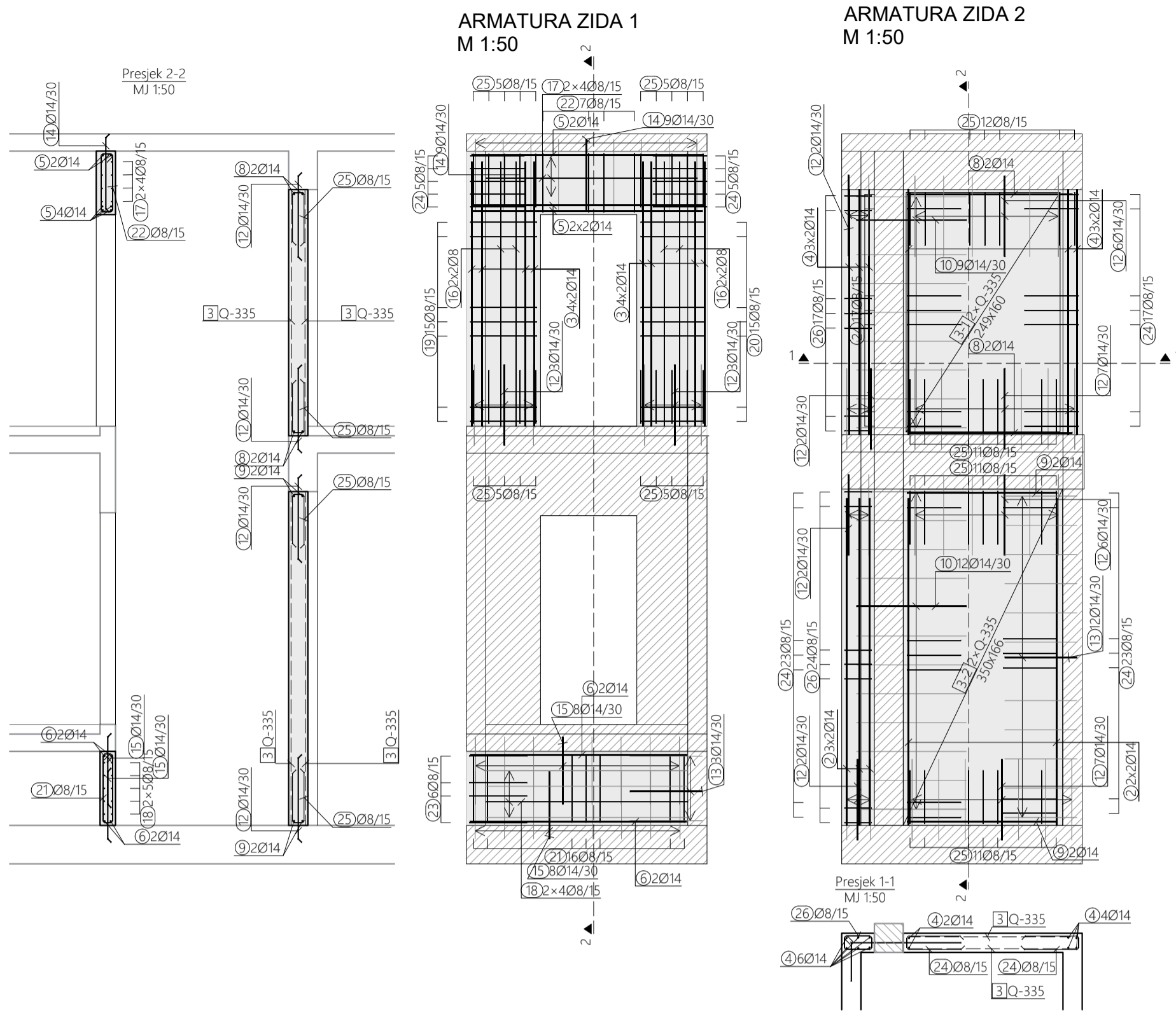

DISPOZICIJA

NAPOMENA:
Veza između novog betona i postojećeg betona se ostvaruje ankerima (šipkama) Ø14 koje je potrebno ubušiti min 2/3 debljine zida u postojeći beton na međusobnoj udaljenosti 30cm. Koristiti sistem naknadnog kemijskog sidrenja (npr. HILTI HIT-RE 500 V3).

DETALJ POSTAVLJANJA DISTANCERA U ZID

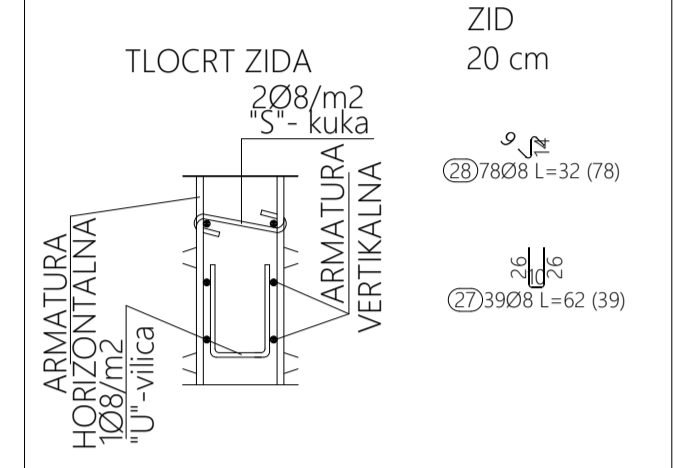

Šipke - specifikacija						
ozn	oblik i mjere [cm]	Ø	lg [m]	n [kom]	lgn [m]	
Armatura dizala D3 (1 kom)						
1	375	14	3.75	2	7.50	
2	340	14	3.40	10	34.00	
3	275	14	2.75	16	44.00	
4	255	14	2.55	12	30.60	
5	240	14	2.40	6	14.40	
6	225	14	2.25	4	9.00	
7	210	14	2.10	2	4.20	
8	170	14	1.70	4	6.80	
9	155	14	1.55	4	6.20	
10	114	14	1.54	21	32.34	
11	138	14	1.38	7	9.66	
12	84	14	0.84	65	54.60	
13	75	14	0.75	15	11.25	
14	74	14	0.74	9	6.66	
15	70	14	0.70	27	18.90	
16	275	8	2.75	8	22.00	
17	220	8	2.20	8	17.60	
18	210	8	2.10	8	16.80	
19	71	8	1.88	15	28.20	
20	67	8	1.80	15	27.00	
21	71	8	1.80	16	28.80	
22	60	8	1.62	7	11.34	
23	60	8	1.28	6	7.68	
24	55	8	1.25	222	277.50	
25	52	8	1.15	145	166.75	
26	28	8	1.02	41	41.82	
27	26	8	0.62	39	24.18	
28	14	8	0.32	78	24.96	

Šipke - rekapitulacija			
Ø [mm]	lgn [m]	Jedinična težina [kg/m²]	Težina [kg]
B500B			
8	694.63	0.40	274.38
14	290.11	1.21	351.03
Ukupno (B500B)			625.41
Ukupno			625.41

Mreže - specifikacija						
Pozicija	Oznaka mreže	B [cm]	L [cm]	n	Jedinična težina [kg/m²]	Ukupna težina [kg]
Armatura dizala D3 (1 kom)						
3-1	Q-335	160	249	2	5.38	42.84
3-2	Q-335	166	350	2	5.38	62.29
3-3	Q-335	210	376	2	5.38	84.95
3-4	Q-335	200	286	4	5.38	123.31
Ukupno						313.38

NAPOMENA
Šipke prilagoditi i po potrebi rezati na licu mjesta. Preklap 50Ø.

NAPOMENA
Sve dimenzije provjeriti prema važećim planovima oplata.

Klasa betona	C 30/37		
Armatura	B 500 B		
Zaštitni sloj betona	Pripadajuća lista armature :		
dolje	gore	bočno	ARM_TK-2_323_ISKAZ
3,0 cm	3,0 cm	3,0 cm	
Pripadajući armaturni nacrti			
ARM_TK-2_323			

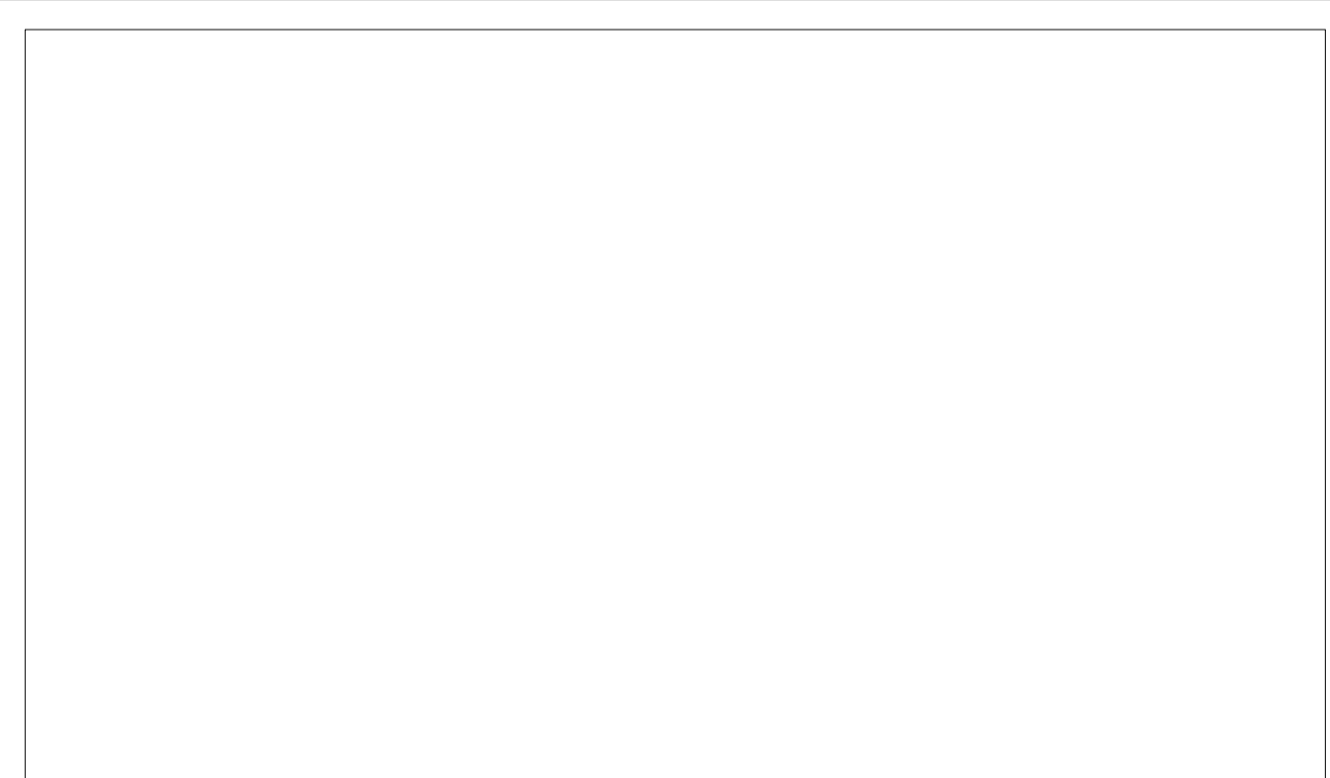

KONSTRUKTA
KONSTRUKTA d.o.o., za projektiranje i nadzor
Desinička 20, ZAGREB, OIB: 06674378579
ŽR: PRIVREDNA BANKA 2340009-1110164468
TEL: 01/36 43 828; FAX: 01/36 43 829
MAIL: info@konstrukta.hr

PEČAT I POTPIS:
Hrvatska Komora Inženjera Građevinarstva
Antonio Maglov
dip. ing. građ.
Ovlašteni inženjer građevinarstva
G 3775

INVESTITOR:	TERME TUHELJ d.o.o. Ljudevita Gaja 4, Tuhejske Toplice, 49215 Tuhej	GL. PROJEKTANT:	Tomislav Vreš, dipl. ing. arh.
GRADEVINA:	REKONSTRUKCIJA TERMALNOG REKREACUSKOG CENTRA TERME TUHELJ	PROJEKT. IZV. PR:	Antonio Maglov, dipl. ing. građ.
LOKACIJA:	na k.č.br. 3199/1, k.o. Črešnjevec	IZRADIO:	Antonio Maglov, dipl. ing. građ.
FAZA:	IZVEDBENI PROJEKT - ARMATURNI NACRTI	DATUM:	svibanj, 2023.
SADRŽAJ:	ELEMENT - DILATACIJA 3 ARMATURA DIZALA PLOČE I ZIDOVİ	MJERILO:	1:50 REVIZIJA: 00
		NACRT BR:	ARM - TK-2 - 323

ISKAZ ARMATURE	
GRAĐEVINA:	REKONSTRUKCIJA TERMALNOG REKREACIJSKOG CENTRA TERME TUHELJ
ISKAZ UZ NACRT:	TK-2-323
SADRŽAJ:	ARMATURA DIZALA DILATACIJE 3
DATUM:	26/07/2023
	1/4

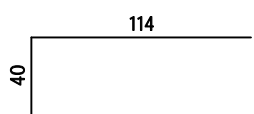
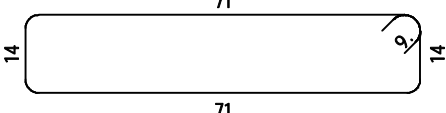
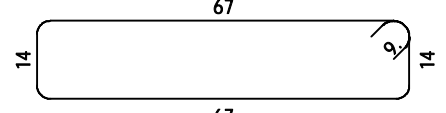
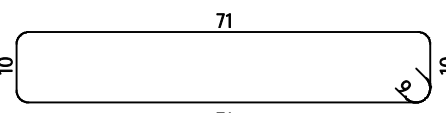
Šipke - specifikacija						
ozn	oblik i mjere [cm]	Ø	lg [m]	n [kom]	lgn [m]	Napomena
Armatura dizala D3 (1 kom)						
1	375	14	3.75	2	7.50	
2	340	14	3.40	10	34.00	
3	275	14	2.75	16	44.00	
4	255	14	2.55	12	30.60	
5	240	14	2.40	6	14.40	
6	225	14	2.25	4	9.00	
7	210	14	2.10	2	4.20	
8	170	14	1.70	4	6.80	
9	155	14	1.55	4	6.20	
10		14	1.54	21	32.34	
11	138	14	1.38	7	9.66	
12	84	14	0.84	65	54.60	
13	75	14	0.75	15	11.25	
14	74	14	0.74	9	6.66	
15	70	14	0.70	27	18.90	
16	275	8	2.75	8	22.00	
17	220	8	2.20	8	17.60	
18	210	8	2.10	8	16.80	
19		8	1.88	15	28.20	
20		8	1.80	15	27.00	
21		8	1.80	16	28.80	

ISKAZ ARMATURE

GRAĐEVINA:	REKONSTRUKCIJA TERMALNOG REKREACIJSKOG CENTRA TERME TUHELJ	
ISKAZ UZ NACRT:	TK-2-323	
SADRŽAJ:	ARMATURA DIZALA DILATACIJE 3	
DATUM:	26/07/2023	2/4

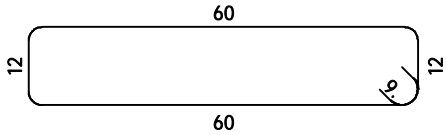
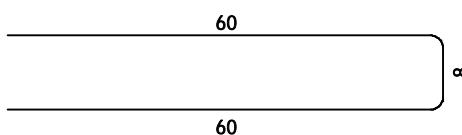
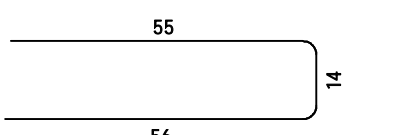
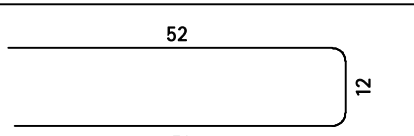
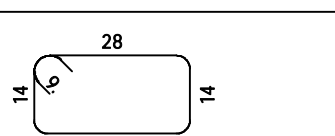
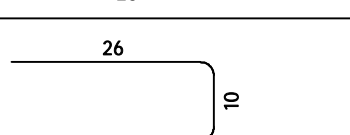
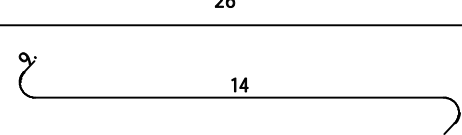
Šipke - specifikacija						
ozn	oblik i mjere [cm]	Ø	lg [m]	n [kom]	lgn [m]	Napomena
22		8	1.62	7	11.34	
23		8	1.28	6	7.68	
24		8	1.25	222	277.50	
25		8	1.15	145	166.75	
26		8	1.02	41	41.82	
27		8	0.62	39	24.18	
28		8	0.32	78	24.96	

ISKAZ ARMATURE			
GRAĐEVINA:	REKONSTRUKCIJA TERMALNOG REKREACIJSKOG CENTRA TERME TUHELJ		
ISKAZ UZ NACRT:	TK-2-323		
SADRŽAJ:	ARMATURA DIZALA DILATACIJE 3		
DATUM:	26/07/2023		3/4

Šipke - rekapitulacija			
Ø [mm]	lgn [m]	Jedinična težina [kg/m ¹]	Težina [kg]
B500B			
8	694.63	0.40	274.38
14	290.11	1.21	351.03
Ukupno (B500B)			625.41
Ukupno			625.41

ISKAZ ARMATURE		
GRAĐEVINA:	REKONSTRUKCIJA TERMALNOG REKREACIJSKOG CENTRA TERME TUHELJ	
ISKAZ UZ NACRT:	TK-2-323	
SADRŽAJ:	ARMATURA DIZALA DILATACIJE 3	
DATUM:	26/07/2023	4/4

Mreže - specifikacija							
Pozicija	Oznaka mreže	B [cm]	L [cm]	n	Jedinična težina [kg/m ²]	Ukupna težina [kg]	Napomena
Armatura dizala D3 (1 kom)							
3-1	Q-335	160	249	2	5.38	42.84	
3-2	Q-335	166	350	2	5.38	62.29	
3-3	Q-335	210	376	2	5.38	84.95	
3-4	Q-335	200	286	4	5.38	123.31	
Ukupno						313.38	

NACRT SAVIJANJA ARMATURE OKOLISA

ARMATURA DONJE ZONE I ANKERI BAZENA, M 1:50

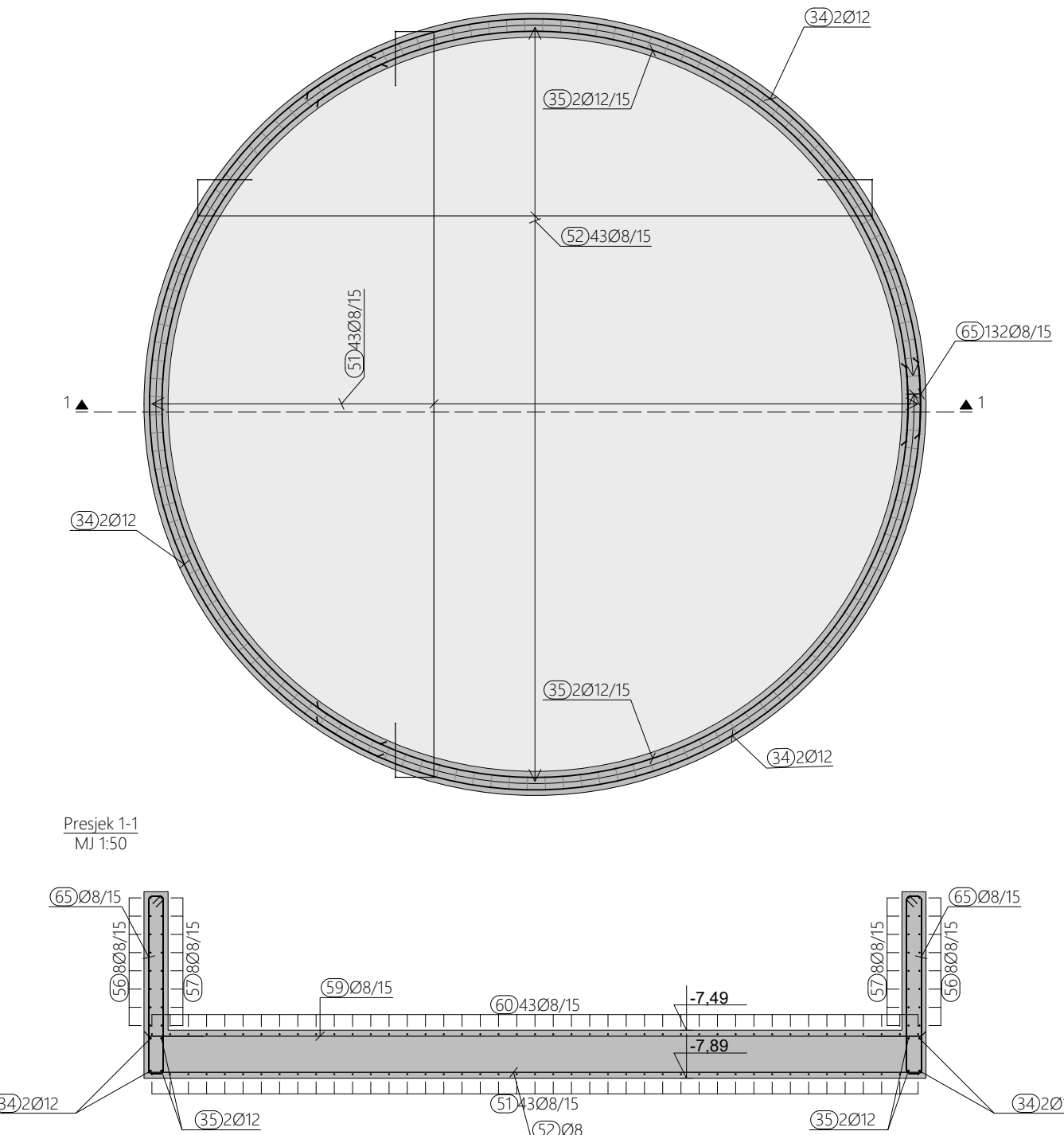

ARMATURA GORNJE ZONE BAZENA, M 1:50

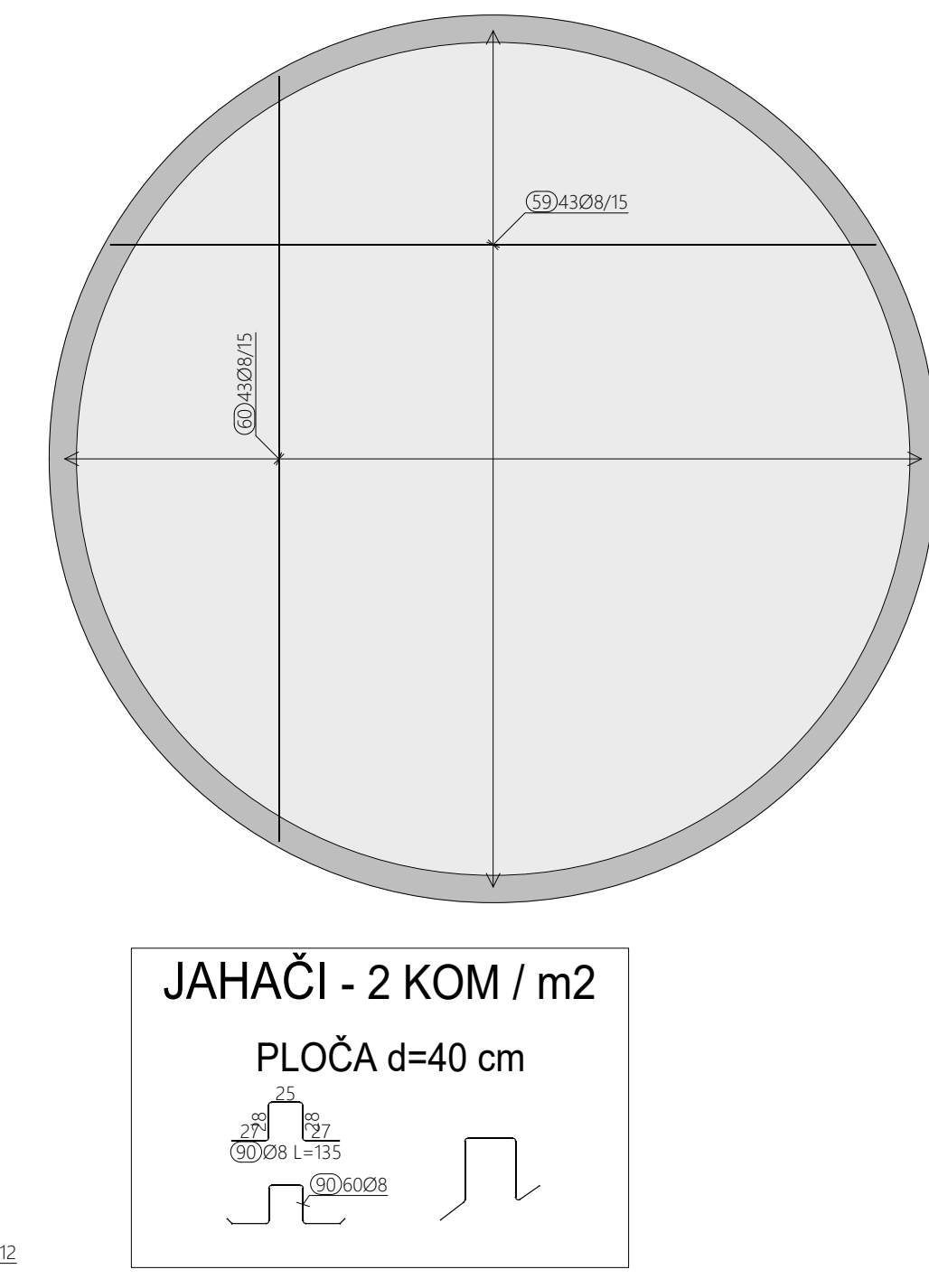

RUBNA OJACANJA BAZENA, M 1:50



JAHAČI - 2 KOM / m²
PLOČA d=40 cm

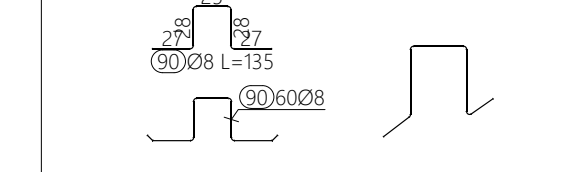

ARMATURA TEMELJNE KONSTRUKCIJE - PLATO 1

DONJA ZONA, RUBNA ARMATURA, ANKERI, GORNJA ZONA, M 1:50

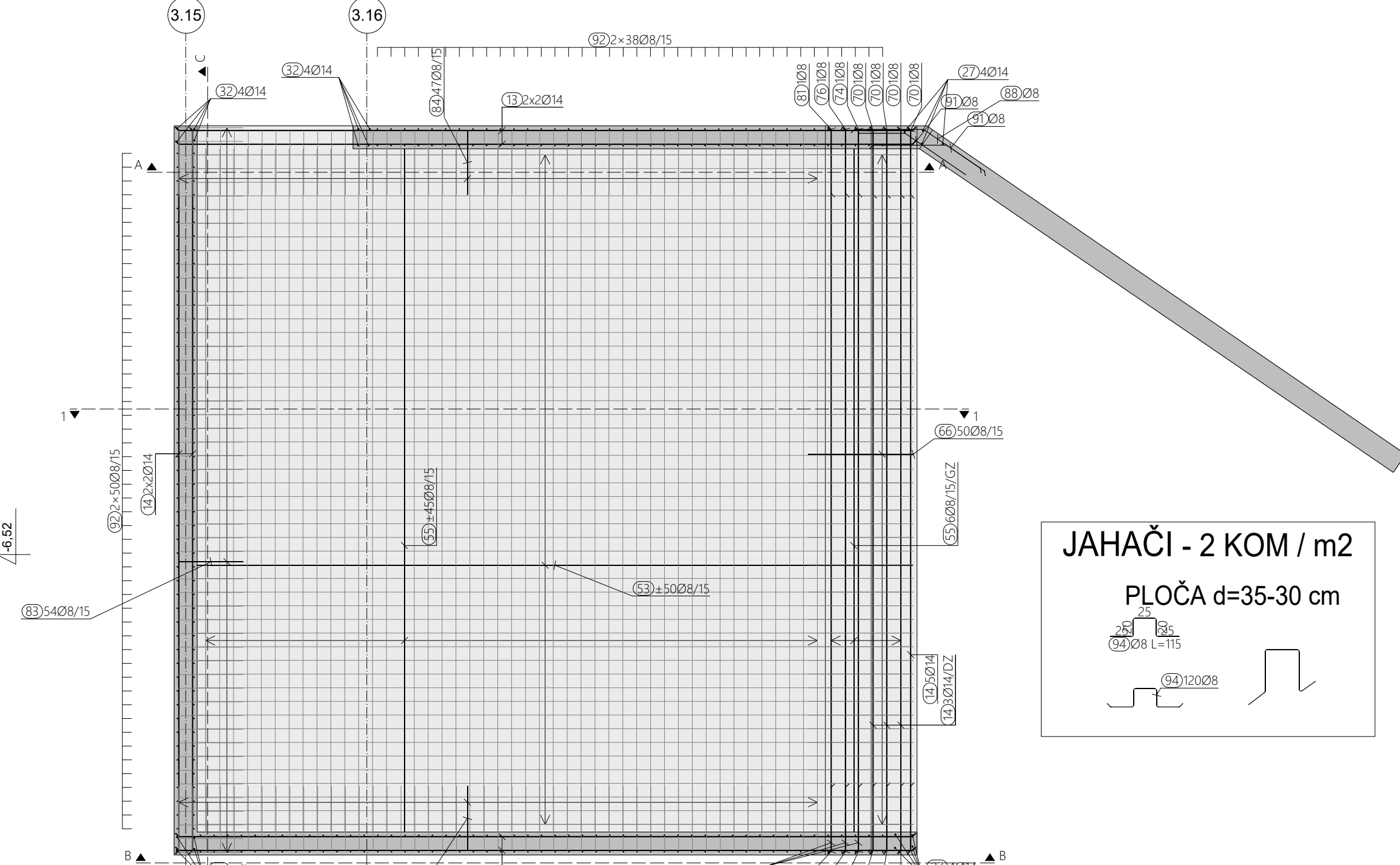

JAHAČI - 2 KOM / m²
PLOČA d=35-30 cm

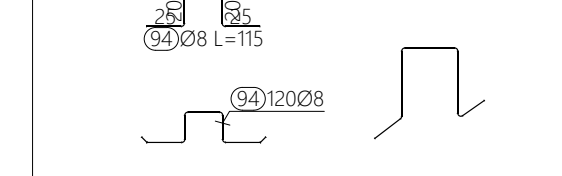

NACRT SAVIJANJA ARMATURE OKOLISA

ARMATURA STROPNE PLOČE, M 1:50

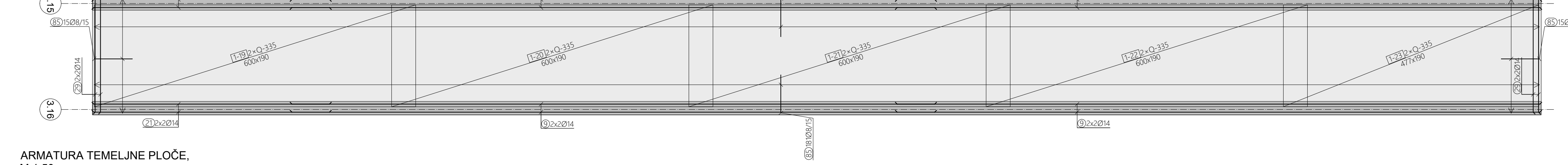

JAHAČI - 2 KOM / m²
PLOČA d=25 cm

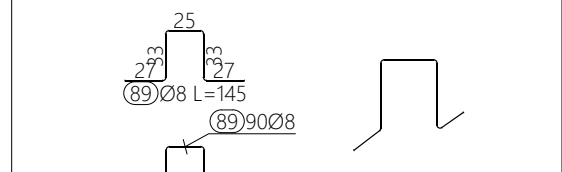

ARMATURA TEMELJNE PLOČE, M 1:50

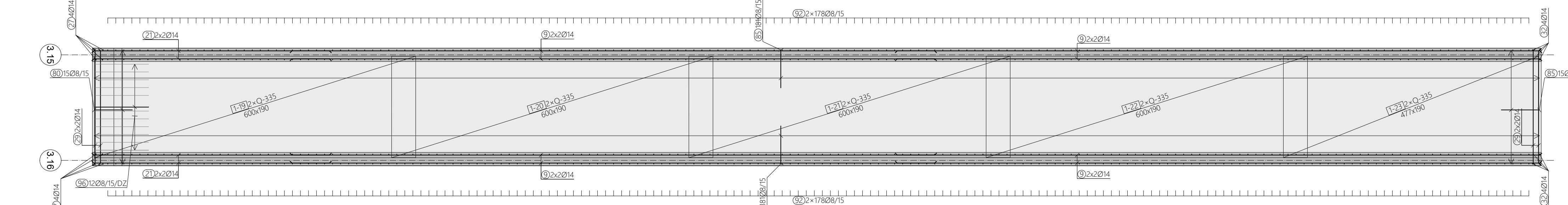

JAHAČI - 2 KOM / m²
PLOČA d=25 cm

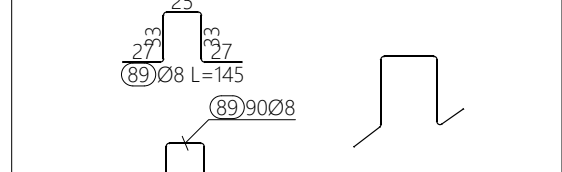

DETALJ POSTAVLJANJA DISTANCERA U ZID

TLOCRT ZIDA 208/m² 25 cm



DETALJ POSTAVLJANJA DISTANCERA U ZID

TLOCRT ZIDA 208/m² 25 cm



ARMATURA ZIDA U OSI 3.15, M 1:50

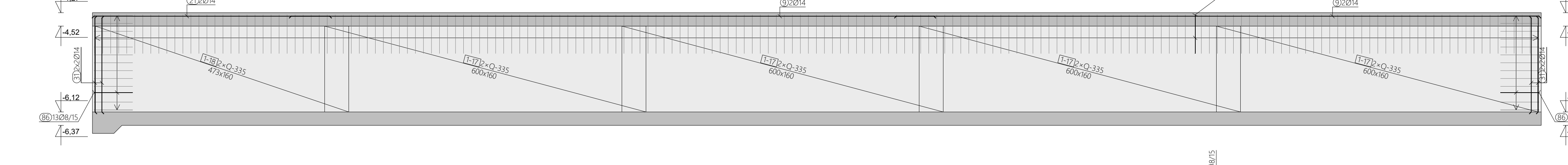

ARMATURA ZIDA U OSI 3.16, M 1:50

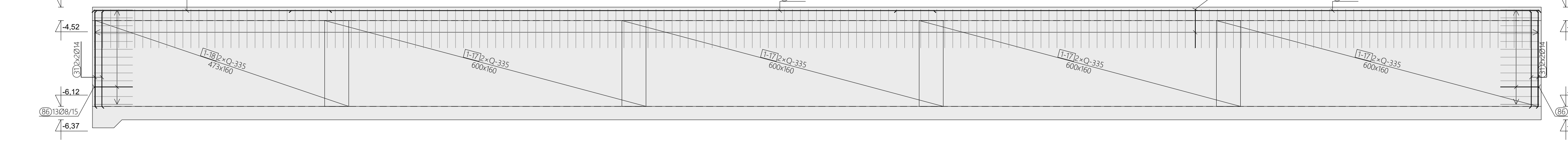

ARMATURA TEMELJNE KONSTRUKCIJE - PLATO 2

DONJA ZONA, RUBNA ARMATURA, ANKERI, GORNJA ZONA, M 1:50

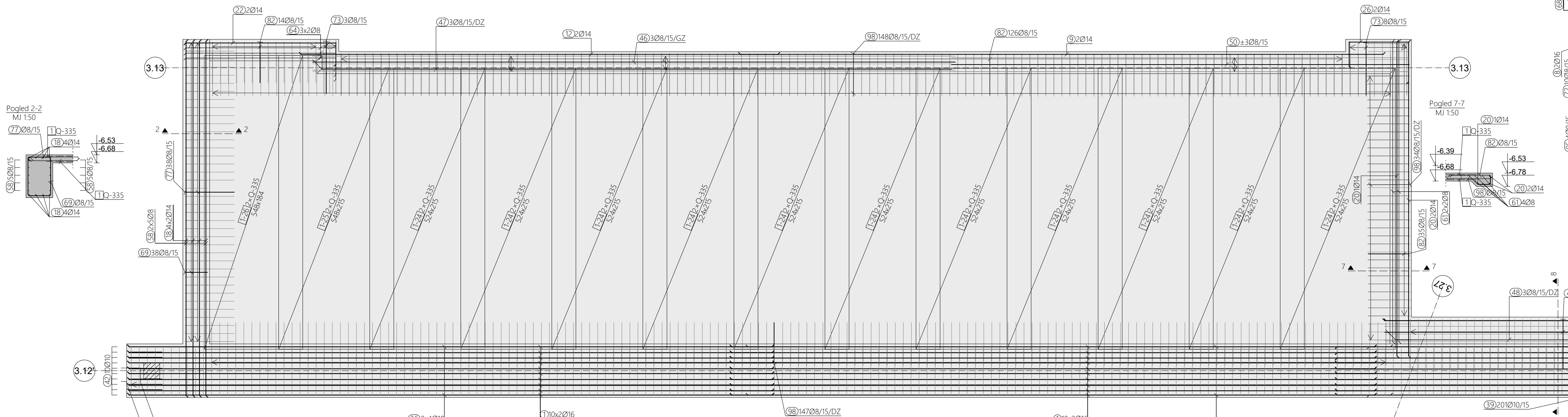

JAHAČI - 2 KOM / m²
PLOČA d=15 cm

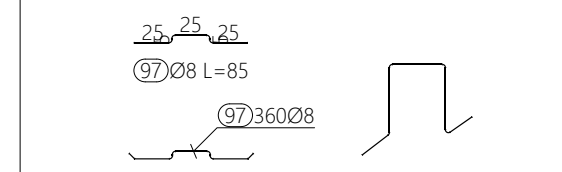

DONJA ZONA, RUBNA ARMATURA, ANKERI, GORNJA ZONA, M 1:50

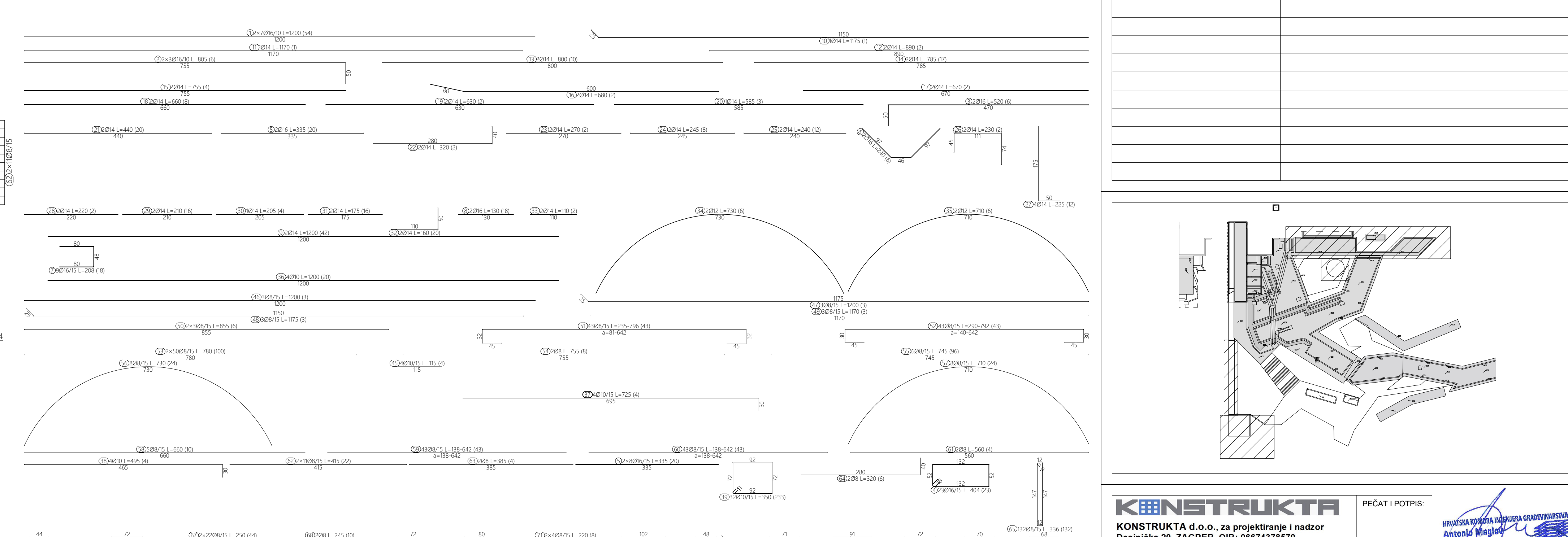
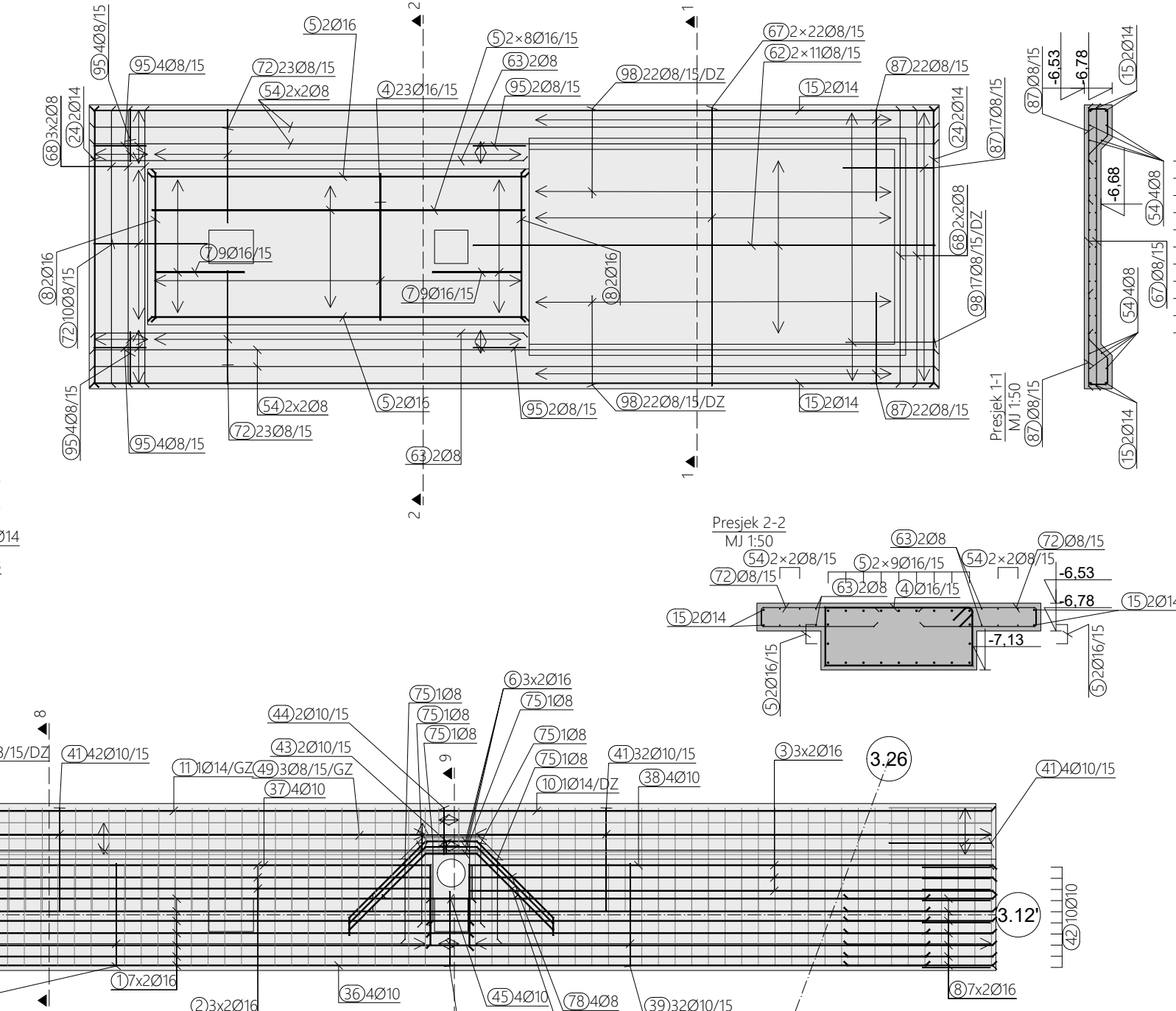

NAPOMENA
Šipke prilagoditi i po potrebi rezati na licu mjesta. Preklap 500.

NAPOMENA
Sve dimenzije provjeriti prema važećim planovima optate.

Klasa betona	C 30/37
Armatura	B 500 B
Zaštitni sloj betona	
doje	gore
4,0 cm	4,0 cm
Pripadajući armaturni nacrti	
Pripadajuća armaturna nacrti	

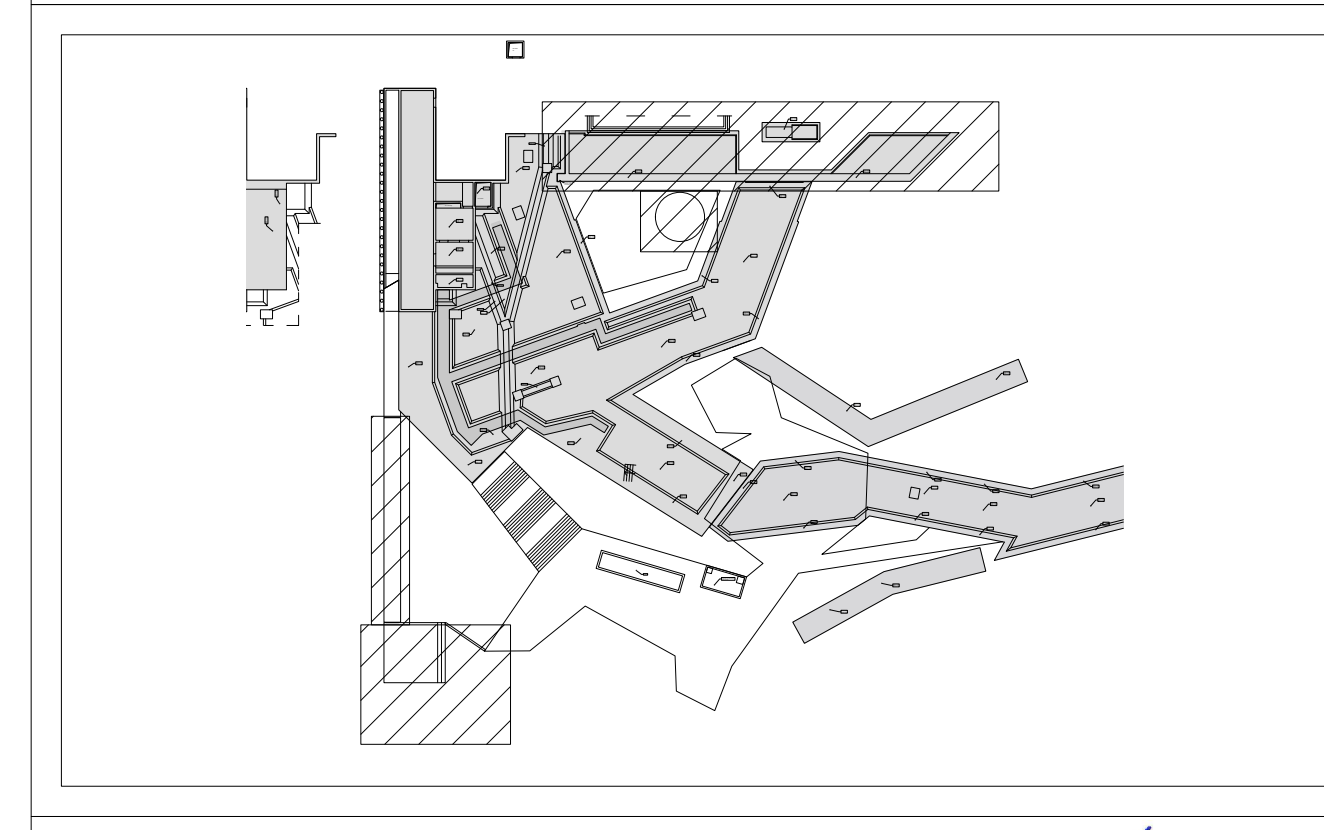



KONSTRUKTA PEČAT I POTPISE

KONSTRUKTA d.o.o. za projektiranje i nadzor
Dionica 29, ZAGREB, OIB: 666747069
ZIR: PRIVREDNA BANKA 2340009-110164468
TEL: 0136 43 828; FAX: 0136 43 829
MAIL: info@konstrakta.hr

INVESTITOR: TERME TUHEL d.o.o. Ljudevita Gaja 4, Tuškanje Toplica, 49215 Tuškanje
GRADJEVINA: REKONSTRUKCIJA TERMANSKO-RENSKOGARSKO CENTRA TERME TUHELJ
LOKACIJA: na k.č.br. 3199/1, k.o. Orešnjevec
FAZA: IZVEDBENI PROJEKT - ARMATURNI NACRTI
SADRŽAJ: ELEMENT - PLOČA TK-2 DILATACIJA S ARMATURA OKOLISA 1

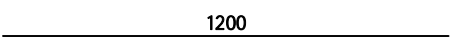
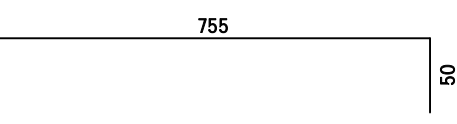
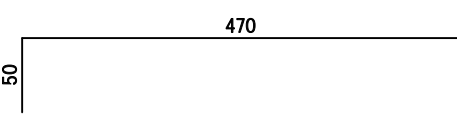
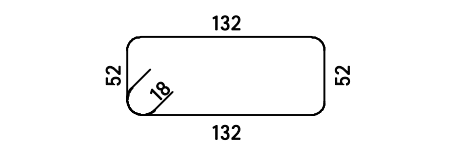
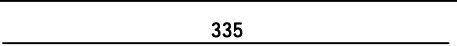
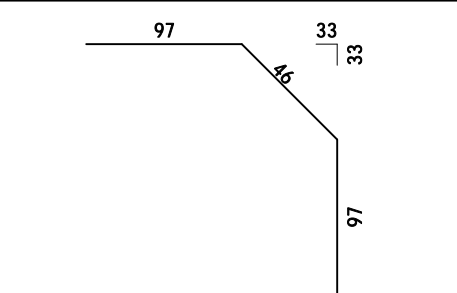
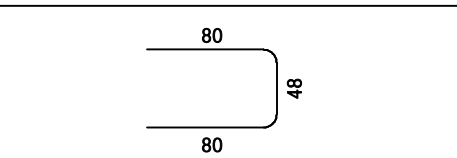
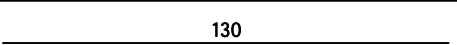
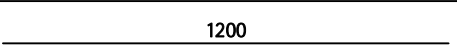

GL. PROJEKTANT: Tomislav Vreć, dipl. ing. arh.
PROJEKT. UV. PR. ZBRADJO: Antono Maglov, dipl. ing. grad.
DATUM: 09.06.2023
MISRELO: 1:50
REVIZIJA: 00
NACRT BR.: ARM - TK-2 - 324

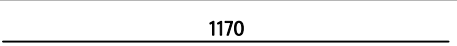
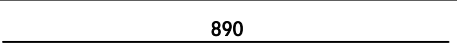
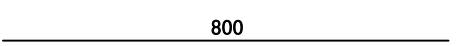
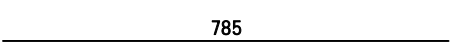
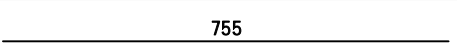
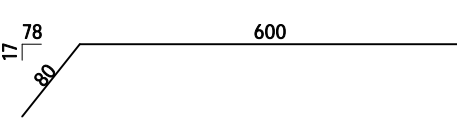
ISKAZ ARMATURE		
GRAĐEVINA:	REKONSTRUKCIJA TERMALNOG REKREACIJSKOG CENTRA TERME TUHELJ	
ISKAZ UZ NACRT:	TK-2_324	
SADRŽAJ:	ARMATURA OKOLIŠA 1	
DATUM:	srpanj, 2023.	

Šipke - specifikacija						
ozn	oblik i mjere [cm]	Ø	lg [m]	n [kom]	lgn [m]	Napomena
OKOLIŠ (1 kom)						
1		16	12.00	54	648.00	
2		16	8.05	6	48.30	
3		16	5.20	6	31.20	
4		16	4.04	23	92.92	
5		16	3.35	20	67.00	
6		16	2.40	6	14.40	
7		16	2.08	18	37.44	
8		16	1.30	18	23.40	
9		14	12.00	42	504.00	
10		14	11.75	1	11.75	
11		14	11.70	1	11.70	
12		14	8.90	2	17.80	
13		14	8.00	10	80.00	
14		14	7.85	17	133.45	
15		14	7.55	4	30.20	
16		14	6.80	2	13.60	

ISKAZ ARMATURE

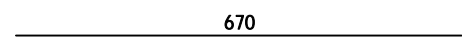
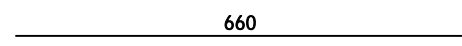
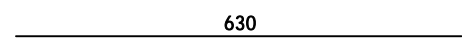
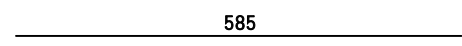
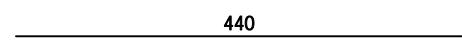
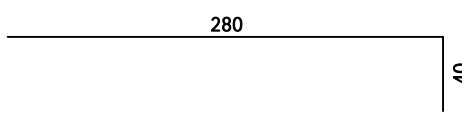
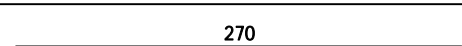
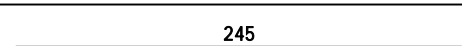
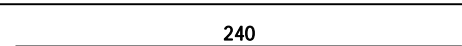
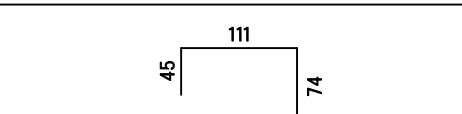
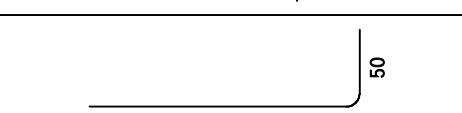
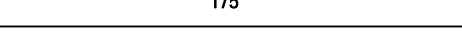
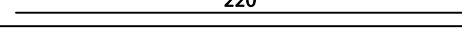
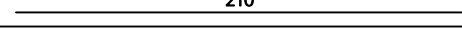
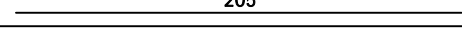
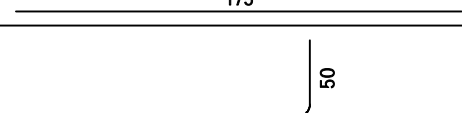
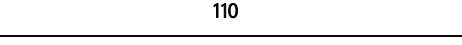
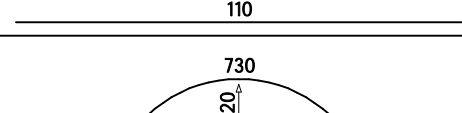
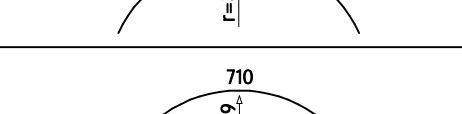
GRAĐEVINA:	REKONSTRUKCIJA TERMALNOG REKREACIJSKOG CENTRA TERME TUHELJ	
ISKAZ UZ NACRT:	TK-2_324	
SADRŽAJ:	ARMATURA OKOLIŠA 1	
DATUM:	srpanj, 2023.	2/10

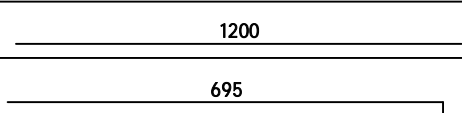
Šipke - specifikacija						
ozn	oblik i mjere [cm]	Ø	lg [m]	n [kom]	lgn [m]	Napomena
17		14	6.70	2	13.40	
18		14	6.60	8	52.80	
19		14	6.30	2	12.60	
20		14	5.85	3	17.55	
21		14	4.40	20	88.00	
22		14	3.20	2	6.40	
23		14	2.70	2	5.40	
24		14	2.45	8	19.60	
25		14	2.40	12	28.80	
26		14	2.30	2	4.60	
27		14	2.25	12	27.00	
28		14	2.20	2	4.40	
29		14	2.10	16	33.60	
30		14	2.05	4	8.20	
31		14	1.75	16	28.00	
32		14	1.60	20	32.00	
33		14	1.10	2	2.20	
34		12	7.30	6	43.80	
35		12	7.10	6	42.60	
36		10	12.00	20	240.00	
37		10	7.25	4	29.00	

ISKAZ ARMATURE

GRAĐEVINA:	REKONSTRUKCIJA TERMALNOG REKREACIJSKOG CENTRA TERME TUHELJ	
ISKAZ UZ NACRT:	TK-2_324	
SADRŽAJ:	ARMATURA OKOLIŠA 1	
DATUM:	srpanj, 2023.	3/10

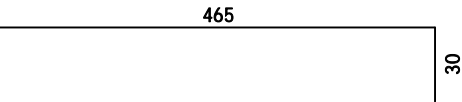
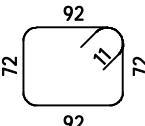
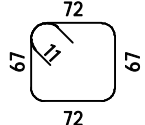
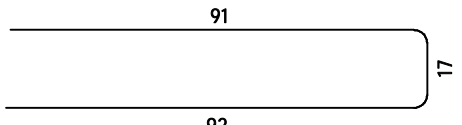
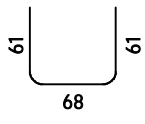
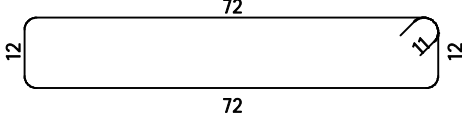
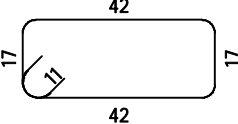
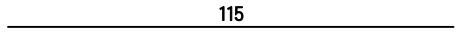
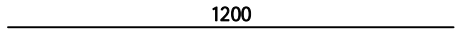
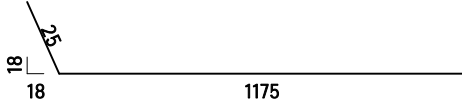
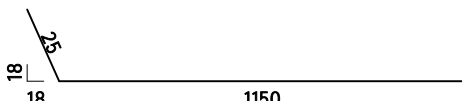
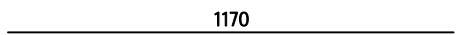
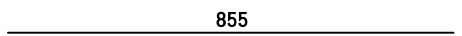
Šipke - specifikacija						
ozn	oblik i mjere [cm]	Ø	lg [m]	n [kom]	lgn [m]	Napomena
38		10	4.95	4	19.80	
39		10	3.50	233	815.50	
40		10	3.00	2	6.00	
41		10	2.00	78	156.00	
42		10	1.90	20	38.00	
43		10	1.90	2	3.80	
44		10	1.40	2	2.80	
45		10	1.15	4	4.60	
46		8	12.00	3	36.00	
47		8	12.00	3	36.00	
48		8	11.75	3	35.25	
49		8	11.70	3	35.10	
50		8	8.55	6	51.30	

ISKAZ ARMATURE

GRAĐEVINA:	REKONSTRUKCIJA TERMALNOG REKREACIJSKOG CENTRA TERME TUHELJ	
ISKAZ UZ NACRT:	TK-2_324	
SADRŽAJ:	ARMATURA OKOLIŠA 1	
DATUM:	srpanj, 2023.	4/10

Šipke - specifikacija

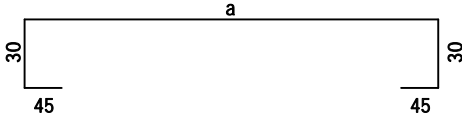
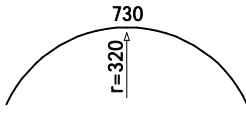
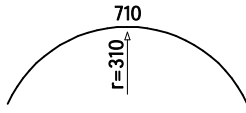
ozn	oblik i mjere [cm]	Ø	lg [m]	n [kom]	lgn [m]	Napomena
51	 <p>a a = 81, 210, 283, 338, 383, 420, 453, 482, 507, 529, 549, 566, 581, 594, 606, 616, 624, 630, 636, 639, 641, 642, 641, 639, 636, 630, 624, 616, 606, 594, 581, 566, 549, 529, 507, 482, 453, 420, 383, 338, 283, 210, 81</p>	8	*6.51	1 x 43	280.00	
52	 <p>a a = 140, 237, 301, 352, 394, 429, 460, 488, 512, 533, 552, 569, 583, 596, 607, 617, 625, 631, 636, 639, 641, 642, 641, 639, 636, 631, 625, 617, 607, 596, 583, 569, 552, 533, 512, 488, 460, 429, 394, 352, 301, 237, 140</p>	8	*6.55	1 x 43	281.76	
53	780	8	7.80	100	780.00	
54	755	8	7.55	8	60.40	
55	745	8	7.45	96	715.20	
56	 <p>730 r=320</p>	8	7.30	24	175.20	
57	 <p>710 r=310</p>	8	7.10	24	170.40	
58	660	8	6.60	10	66.00	
59	<p>a a = 138, 236, 301, 351, 393, 429, 460, 487, 511, 533, 552, 568, 583, 596, 607, 616, 624, 631, 636, 639, 641, 642, 641, 639, 636, 631, 624, 616, 607, 596, 583, 568, 552, 533, 511, 487, 460, 429, 393, 351, 301, 236, 138</p>	8	*5.05	1 x 43	217.06	
60	<p>a a = 138, 236, 301, 351, 393, 429, 460, 487, 511, 533, 552, 568, 583, 596, 607, 616, 624, 631, 636, 639, 641, 642, 641, 639, 636, 631, 624, 616, 607, 596, 583, 568, 552, 533, 511, 487, 460, 429, 393, 351, 301, 236, 138</p>	8	*5.05	1 x 43	217.06	
61	560	8	5.60	4	22.40	
62	415	8	4.15	22	91.30	
63	385	8	3.85	4	15.40	

ISKAZ ARMATURE

GRAĐEVINA:	REKONSTRUKCIJA TERMALNOG REKREACIJSKOG CENTRA TERME TUHELJ	
ISKAZ UZ NACRT:	TK-2_324	
SADRŽAJ:	ARMATURA OKOLIŠA 1	
DATUM:	srpanj, 2023.	5/10

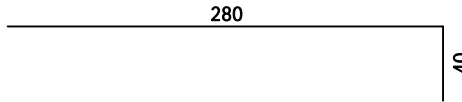
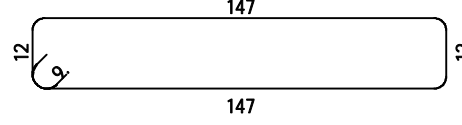
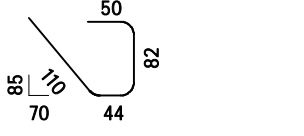
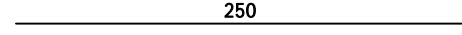
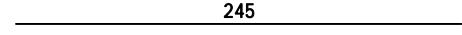
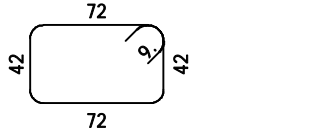
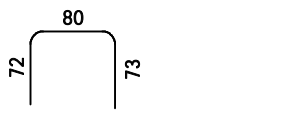
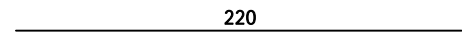
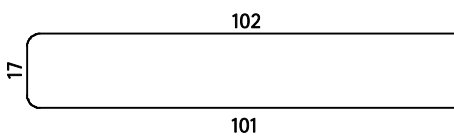
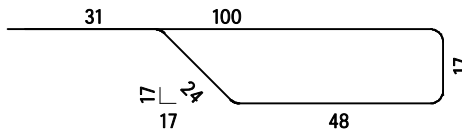
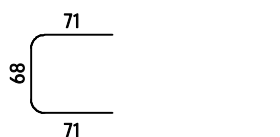
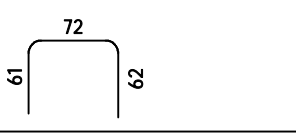
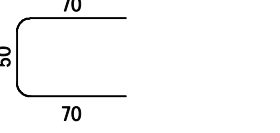
Šipke - specifikacija						
ozn	oblik i mjere [cm]	Ø	lg [m]	n [kom]	lgn [m]	Napomena
64		8	3.20	6	19.20	
65		8	3.36	132	443.52	
66		8	2.86	50	143.00	
67		8	2.50	44	110.00	
68		8	2.45	10	24.50	
69		8	2.46	38	93.48	
70		8	2.25	8	18.00	
71		8	2.20	8	17.60	
72		8	2.20	56	123.20	
73		8	2.20	11	24.20	
74		8	2.10	2	4.20	
75		8	1.95	6	11.70	
76		8	1.90	2	3.80	

ISKAZ ARMATURE

GRAĐEVINA:	REKONSTRUKCIJA TERMALNOG REKREACIJSKOG CENTRA TERME TUHELJ	
ISKAZ UZ NACRT:	TK-2_324	
SADRŽAJ:	ARMATURA OKOLIŠA 1	
DATUM:	srpanj, 2023.	6/10

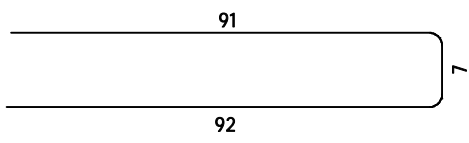
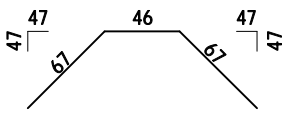
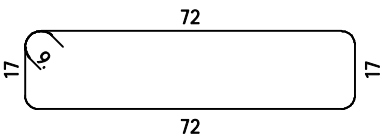
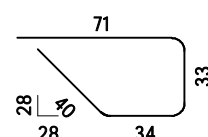
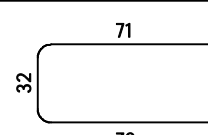
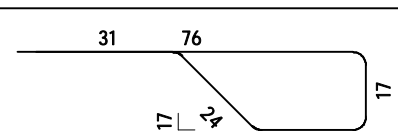
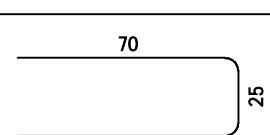
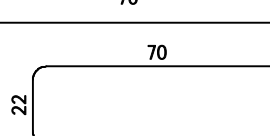
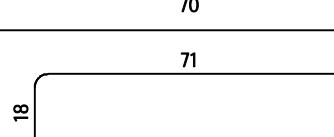
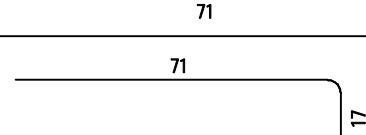
Šipke - specifikacija						
ozn	oblik i mjere [cm]	Ø	lg [m]	n [kom]	lgn [m]	Napomena
77		8	1.90	38	72.20	
78		8	1.80	8	14.40	
79		8	1.96	11	21.56	
80		8	1.78	15	26.70	
81		8	1.75	2	3.50	
82		8	1.72	175	301.00	
83		8	1.65	54	89.10	
84		8	1.62	94	152.28	
85		8	1.60	769	1230.40	
86		8	1.60	654	1046.40	

ISKAZ ARMATURE

GRAĐEVINA:	REKONSTRUKCIJA TERMALNOG REKREACIJSKOG CENTRA TERME TUHELJ	
ISKAZ UZ NACRT:	TK-2_324	
SADRŽAJ:	ARMATURA OKOLIŠA 1	
DATUM:	srpanj, 2023.	7/10

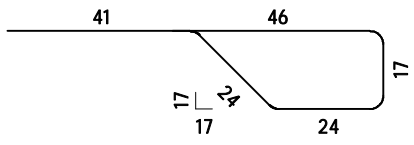
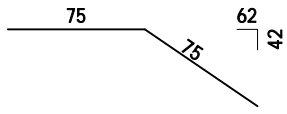
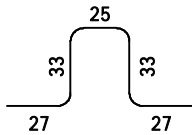
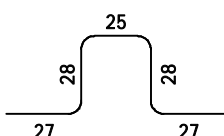
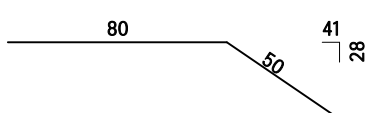
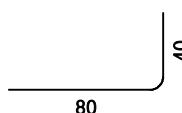
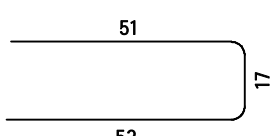
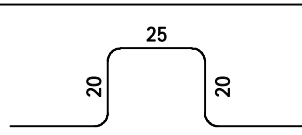
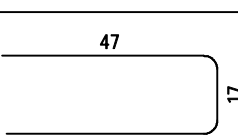
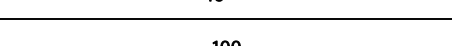
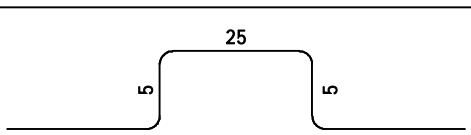
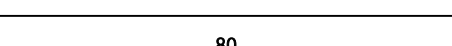
Šipke - specifikacija						
ozn	oblik i mjere [cm]	Ø	lg [m]	n [kom]	lgn [m]	Napomena
87		8	1.52	61	92.72	
88		8	1.50	14	21.00	
89		8	1.45	180	261.00	
90		8	1.35	60	81.00	
91		8	1.30	28	36.40	
92		8	1.20	990	1188.00	
93		8	1.20	83	99.60	
94		8	1.15	120	138.00	
95		8	1.10	20	22.00	
96		8	1.00	12	12.00	
97		8	0.85	360	306.00	
98		8	0.80	390	312.00	

ISKAZ ARMATURE		
GRAĐEVINA:	REKONSTRUKCIJA TERMALNOG REKREACIJSKOG CENTRA TERME TUHELJ	
ISKAZ UZ NACRT:	TK-2_324	
SADRŽAJ:	ARMATURA OKOLIŠA 1	
DATUM:	srpanj, 2023.	8/10

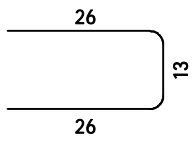
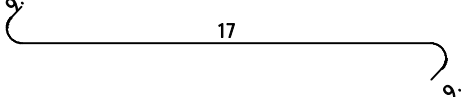
Šipke - specifikacija						
ozn	oblik i mjere [cm]	Ø	lg [m]	n [kom]	lgn [m]	Napomena
99		8	0.65	148	96.20	
100		8	0.35	296	103.60	

ISKAZ ARMATURE		
GRAĐEVINA:	REKONSTRUKCIJA TERMALNOG REKREACIJSKOG CENTRA TERME TUHELJ	
ISKAZ UZ NACRT:	TK-2_324	
SADRŽAJ:	ARMATURA OKOLIŠA 1	
DATUM:	srpanj, 2023.	9/10

Šipke - rekapitulacija			
Ø [mm]	lgn [m]	Jedinična težina [kg/m ¹]	Težina [kg]
B500B			
8	10049.29	0.40	3969.47
10	1315.50	0.62	811.66
12	86.40	0.89	76.72
14	1187.05	1.21	1436.33
16	962.66	1.58	1521.00
Ukupno (B500B)			7815.19
Ukupno			7815.19

ISKAZ ARMATURE		
GRAĐEVINA:	REKONSTRUKCIJA TERMALNOG REKREACIJSKOG CENTRA TERME TUHELJ	
ISKAZ UZ NACRT:	TK-2_324	
SADRŽAJ:	ARMATURA OKOLIŠA 1	
DATUM:	srpanj, 2023.	10/10

Mreže - specifikacija							
Pozicija	Oznaka mreže	B [cm]	L [cm]	n	Jedinična težina [kg/m ²]	Ukupna težina [kg]	Napomena
OKOLIŠ (1 kom)							
1-1	Q-335	215	246	8	5.38	227.82	
1-2	Q-335	65	246	2	5.38	17.22	
1-3	Q-335	215	206	2	5.38	47.77	
1-4	Q-335	215	180	2	5.38	41.74	
1-5	Q-335	215	154	2	5.38	35.71	
1-6	Q-335	113	128	2	5.38	15.59	
1-7	Q-335	215	244	2	5.38	56.44	
1-8	Q-335	215	244	2	5.38	56.34	
1-9	Q-335	215	243	2	5.38	56.24	
1-10	Q-335	215	243	2	5.38	56.14	
1-11	Q-335	95	242	2	5.38	24.72	
1-12	Q-335	215	166	2	5.38	38.32	
1-13	Q-335	215	200	2	5.38	46.34	
1-14	Q-335	215	235	2	5.38	54.36	
1-15	Q-335	98	241	2	5.38	25.47	
1-16	Q-335	45	130	2	5.38	6.29	
1-17	Q-335	160	600	16	5.38	826.37	
1-18	Q-335	160	473	4	5.38	162.86	
1-19	Q-335	190	600	4	5.38	245.30	
1-20	Q-335	190	600	4	5.38	245.24	
1-21	Q-335	190	600	4	5.38	245.17	
1-22	Q-335	190	600	4	5.38	245.10	
1-23	Q-335	190	477	4	5.38	194.78	
1-24	Q-335	215	524	22	5.38	1333.44	
1-25	Q-335	215	548	2	5.38	126.77	
1-26	Q-335	184	548	2	5.38	108.40	
Ukupno						4539.94	

NACRT SAVIJANJA ARMATURE STROPNE PLOČE - ETAŽA -2

RUBNA ARMATURA I ARMATURA DONJE ZONE,
PLOČA NA VISINSKOJ KOTI -2.64/-2.89,
M 1:50

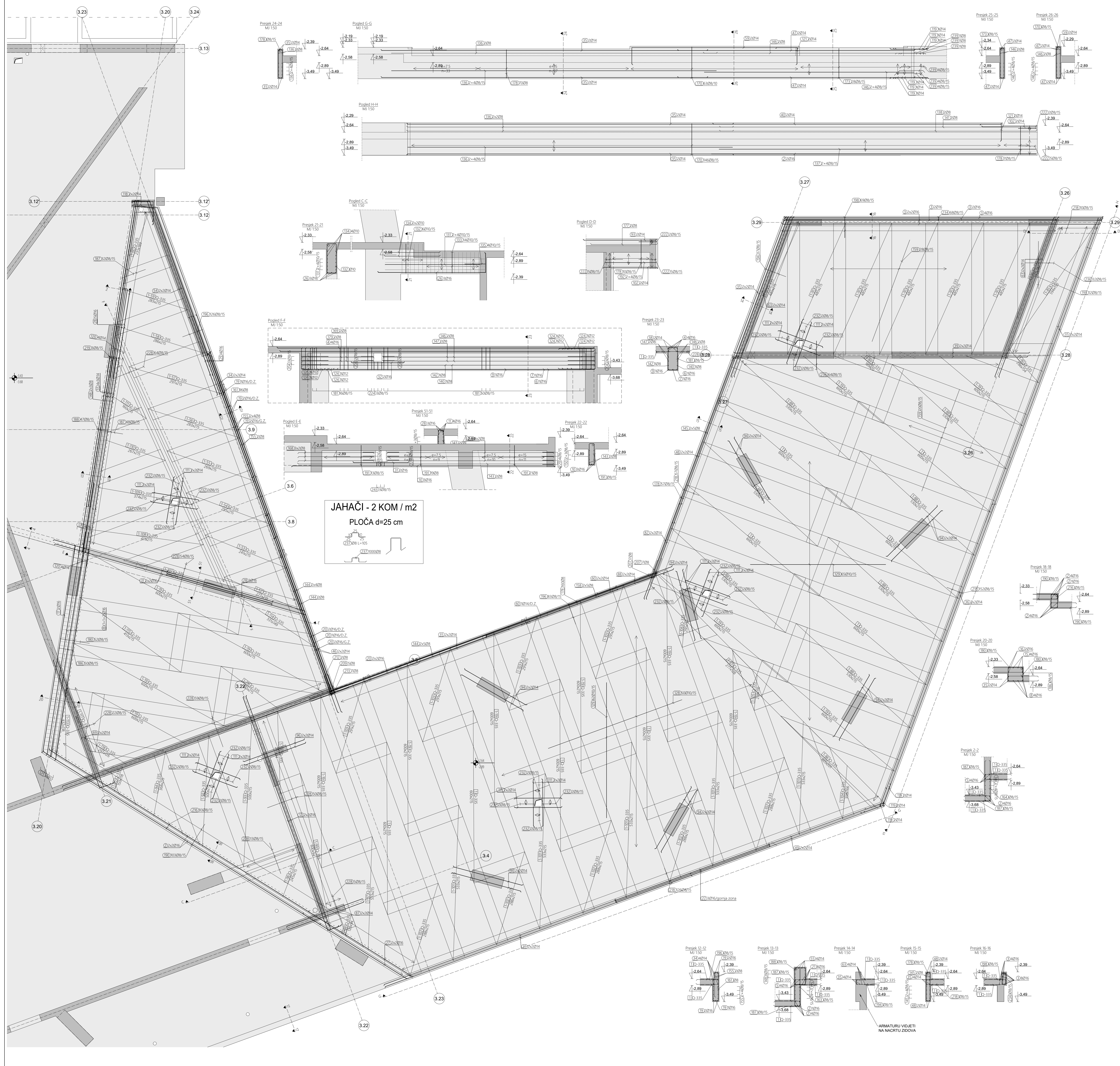

Red. br.	Opis	Ukupno	Ukupno dužina	Ukupno površina	Ukupno masa
1	1.000	1000	1000	1000	1000
2
3
4
5
6
7
8
9
10
11
12
13
14
15
16
17
18
19
20
21
22
23
24
25
26
27
28
29
30
31
32
33
34
35
36
37
38
39
40
41
42
43
44
45
46
47
48
49
50
51
52
53
54
55
56
57
58
59
60
61
62
63
64
65
66
67
68
69
70
71
72
73
74
75
76
77
78
79
80
81
82
83
84
85
86
87
88
89
90
91
92
93
94
95
96
97
98
99
100

NAPOMENA
Slike prilagoditi po potrebi rezali na licu mjesta. Preklap 50%.
NAPOMENA
Sve dimenzije provjeriti prema važećim planovima optate.

Klasa betona		C 30/37	
Armatura		B 500 B	
Zaštitni sloj betona		Pripadajuća klasa armature	ARM_E-2_301-308_ISKAZ
dolje	gore	bočno	3.0 cm
Pripadajući armaturni nacrti			
ARM_E-2_302-308			
ARM_E-2_321			

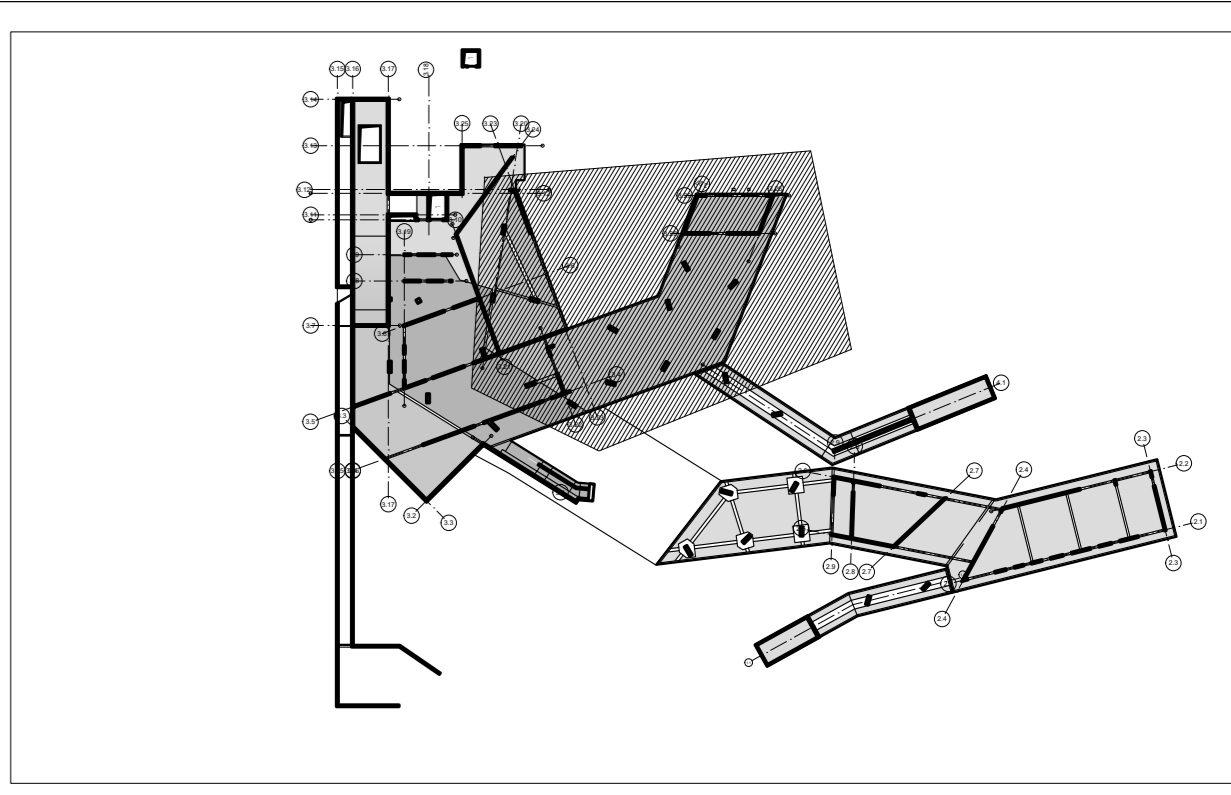

KONSTRUKTA PEČAT I POTPIS

KONSTRUKTA d.o.o. za projektiranje i nadzor
Desimka 29, ZAGREB, OIB: 0687437579
Zr: PRIVREDNA BANKA 2340000-111014468
TEL: 01136 43 828; FAX: 01136 43 829
MAIL: info@konstrukt.hr

INVESTITOR: TERME TUREŠJI d.o.o. Ujdojna Gopa 4,
Turešji Topoli, 88212 Turešji
GRAĐEVNA: REKONSTRUKCIJA TERMOBANE REKONSTRUKCIJSKOG
CENTRA TERME TUREŠJI
LOKACIJA: na k.č.br. 3119/1, k.o. Črešnjavec
FAZ: IZVEŠENI PROJEKT - ARMATURNI NACRTI
ŠKORIŠ: ELEMENT - PLOČA E-2 DILATACIJA 3
RUB. ARMATURA I DONJA ZONA

GL. PROJEKTANT: Tomislav Vest, dpt. ing. arh.
PROJEKT. LEV. PR: Arno Maglov, dpt. ing. graf.
IZRABIO: Arno Maglov, dpt. ing. graf.
DATUM: 19.09.2023.
MISLO: 1:50
REVOLVA: 00
NACRT BR: **ARM - E-2 - 301**

RUBNA ARMATURA I ARMATURA DONJE ZONE.
PLOČA NA VISINSKOJ KOTI -3.74/-3.99.
M 1:50

JAHAČI - 2 KOM / m²
PLOČA d=25 cm

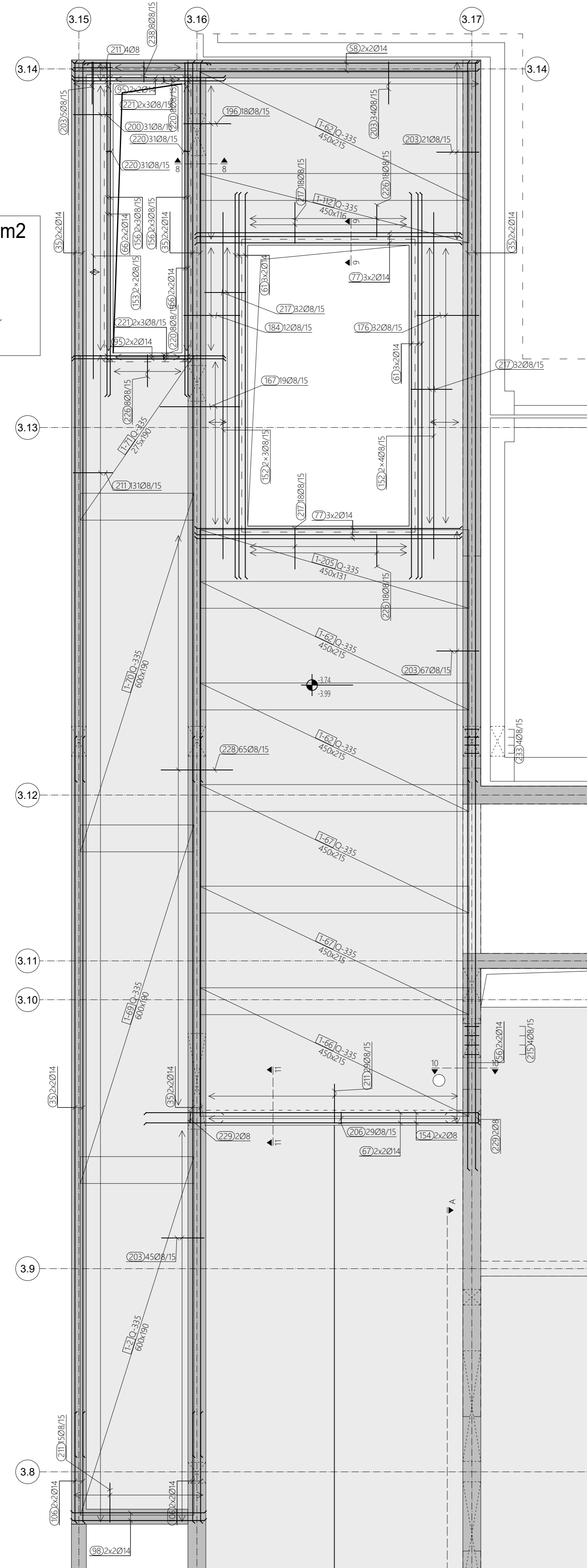

RUBNA ARMATURA I ARMATURA DONJE ZONE.
PLOČA NA VISINSKOJ KOTI -2.64/-2.89.
M 1:50

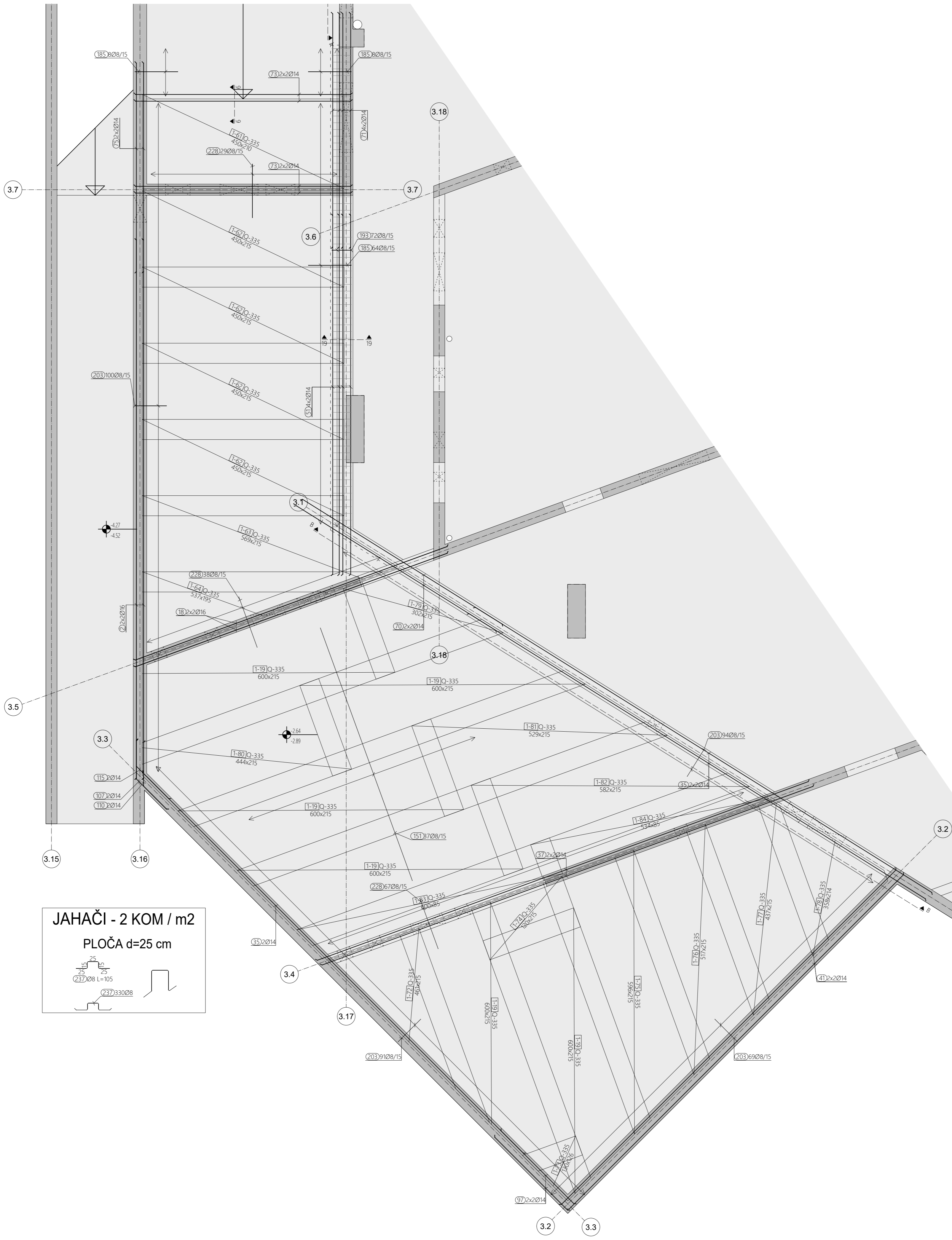

JAHAČI - 2 KOM / m²
PLOČA d=25 cm

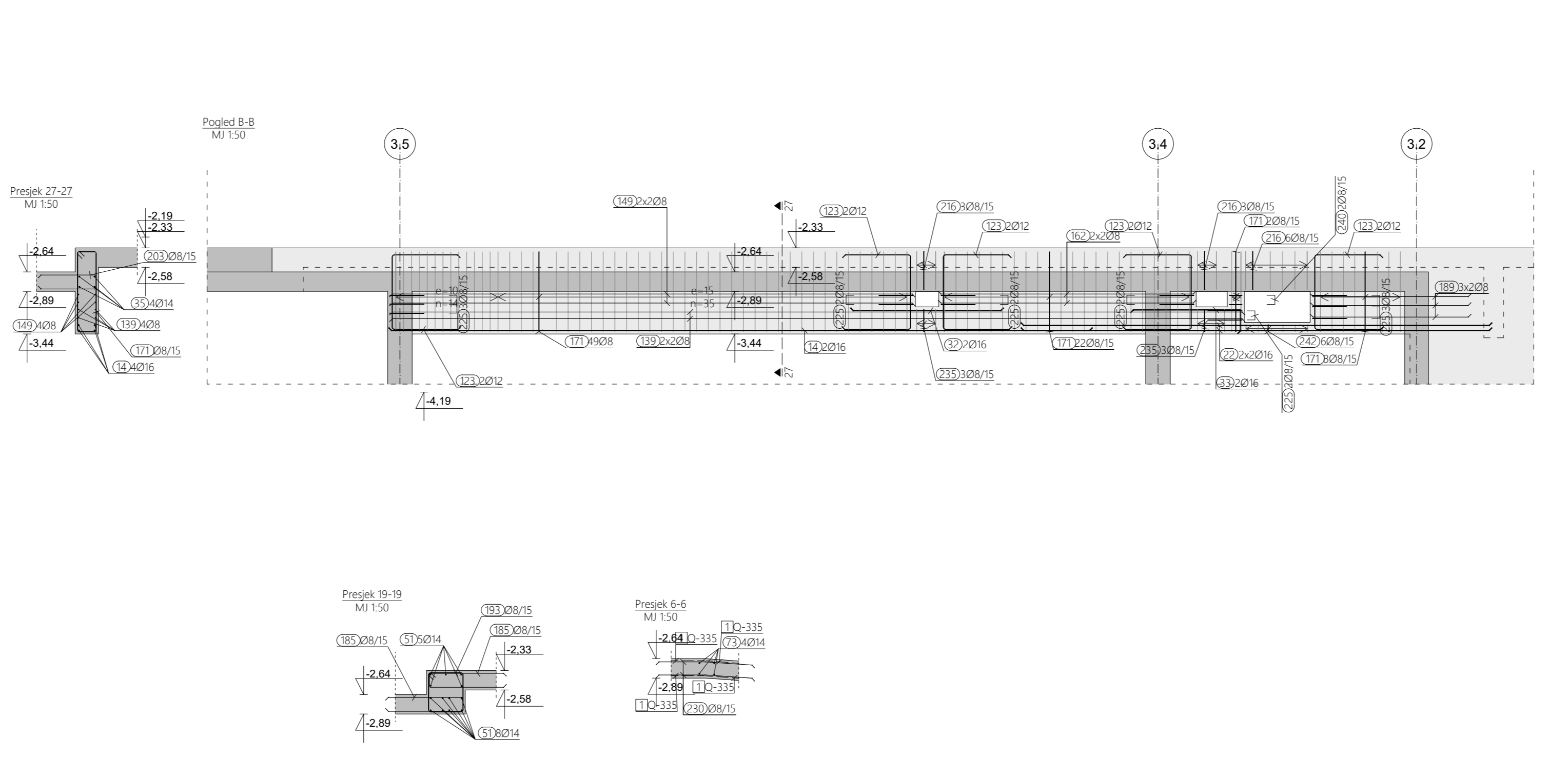

Šifra	Opis	Šifra	Opis	Šifra	Opis	Šifra	Opis
1	300	10	100	20	200	30	300
2	300	10	100	20	200	30	300
3	300	10	100	20	200	30	300
4	300	10	100	20	200	30	300
5	300	10	100	20	200	30	300
6	300	10	100	20	200	30	300
7	300	10	100	20	200	30	300
8	300	10	100	20	200	30	300
9	300	10	100	20	200	30	300
10	300	10	100	20	200	30	300
11	300	10	100	20	200	30	300
12	300	10	100	20	200	30	300
13	300	10	100	20	200	30	300
14	300	10	100	20	200	30	300
15	300	10	100	20	200	30	300
16	300	10	100	20	200	30	300
17	300	10	100	20	200	30	300
18	300	10	100	20	200	30	300
19	300	10	100	20	200	30	300
20	300	10	100	20	200	30	300
21	300	10	100	20	200	30	300
22	300	10	100	20	200	30	300
23	300	10	100	20	200	30	300
24	300	10	100	20	200	30	300
25	300	10	100	20	200	30	300
26	300	10	100	20	200	30	300
27	300	10	100	20	200	30	300
28	300	10	100	20	200	30	300
29	300	10	100	20	200	30	300
30	300	10	100	20	200	30	300
31	300	10	100	20	200	30	300
32	300	10	100	20	200	30	300
33	300	10	100	20	200	30	300
34	300	10	100	20	200	30	300
35	300	10	100	20	200	30	300
36	300	10	100	20	200	30	300
37	300	10	100	20	200	30	300
38	300	10	100	20	200	30	300
39	300	10	100	20	200	30	300
40	300	10	100	20	200	30	300
41	300	10	100	20	200	30	300
42	300	10	100	20	200	30	300
43	300	10	100	20	200	30	300
44	300	10	100	20	200	30	300
45	300	10	100	20	200	30	300
46	300	10	100	20	200	30	300
47	300	10	100	20	200	30	300
48	300	10	100	20	200	30	300
49	300	10	100	20	200	30	300
50	300	10	100	20	200	30	300
51	300	10	100	20	200	30	300
52	300	10	100	20	200	30	300
53	300	10	100	20	200	30	300
54	300	10	100	20	200	30	300
55	300	10	100	20	200	30	300
56	300	10	100	20	200	30	300
57	300	10	100	20	200	30	300
58	300	10	100	20	200	30	300
59	300	10	100	20	200	30	300
60	300	10	100	20	200	30	300
61	300	10	100	20	200	30	300
62	300	10	100	20	200	30	300
63	300	10	100	20	200	30	300
64	300	10	100	20	200	30	300
65	300	10	100	20	200	30	300
66	300	10	100	20	200	30	300
67	300	10	100	20	200	30	300
68	300	10	100	20	200	30	300
69	300	10	100	20	200	30	300
70	300	10	100	20	200	30	300
71	300	10	100	20	200	30	300
72	300	10	100	20	200	30	300
73	300	10	100	20	200	30	300
74	300	10	100	20	200	30	300
75	300	10	100	20	200	30	300
76	300	10	100	20	200	30	300
77	300	10	100	20	200	30	300
78	300	10	100	20	200	30	300
79	300	10	100	20	200	30	300
80	300	10	100	20	200	30	300
81	300	10	100	20	200	30	300
82	300	10	100	20	200	30	300
83	300	10	100	20	200	30	300
84	300	10	100	20	200	30	300
85	300	10	100	20	200	30	300
86	300	10	100	20	200	30	300
87	300	10	100	20	200	30	300
88	300	10	100	20	200	30	300
89	300	10	100	20	200	30	300
90	300	10	100	20	200	30	300
91	300	10	100	20	200	30	300
92	300	10	100	20	200	30	300
93	300	10	100	20	200	30	300
94	300	10	100	20	200	30	300
95	300	10	100	20	200	30	300
96	300	10	100	20	200	30	300
97	300	10	100	20	200	30	300
98	300	10	100	20	200	30	300
99	300	10	100	20	200	30	300
100	300	10	100	20	200	30	300

NAPOMENA
Šipke prilagoditi i po potrebi rezati na licu mjesta. Preklap 500.

NAPOMENA
Sve dimenzije provjeriti prema važećim planovima oplate.

Klasa betona	C 30/37
Armatura	B 500 B
Zaštitni sloj betona	3,0 cm
dođe	3,0 cm
bočno	3,0 cm
Pripadajući armaturni nacrti	ARM_E-2_301_303-308
	ARM_E-2_321

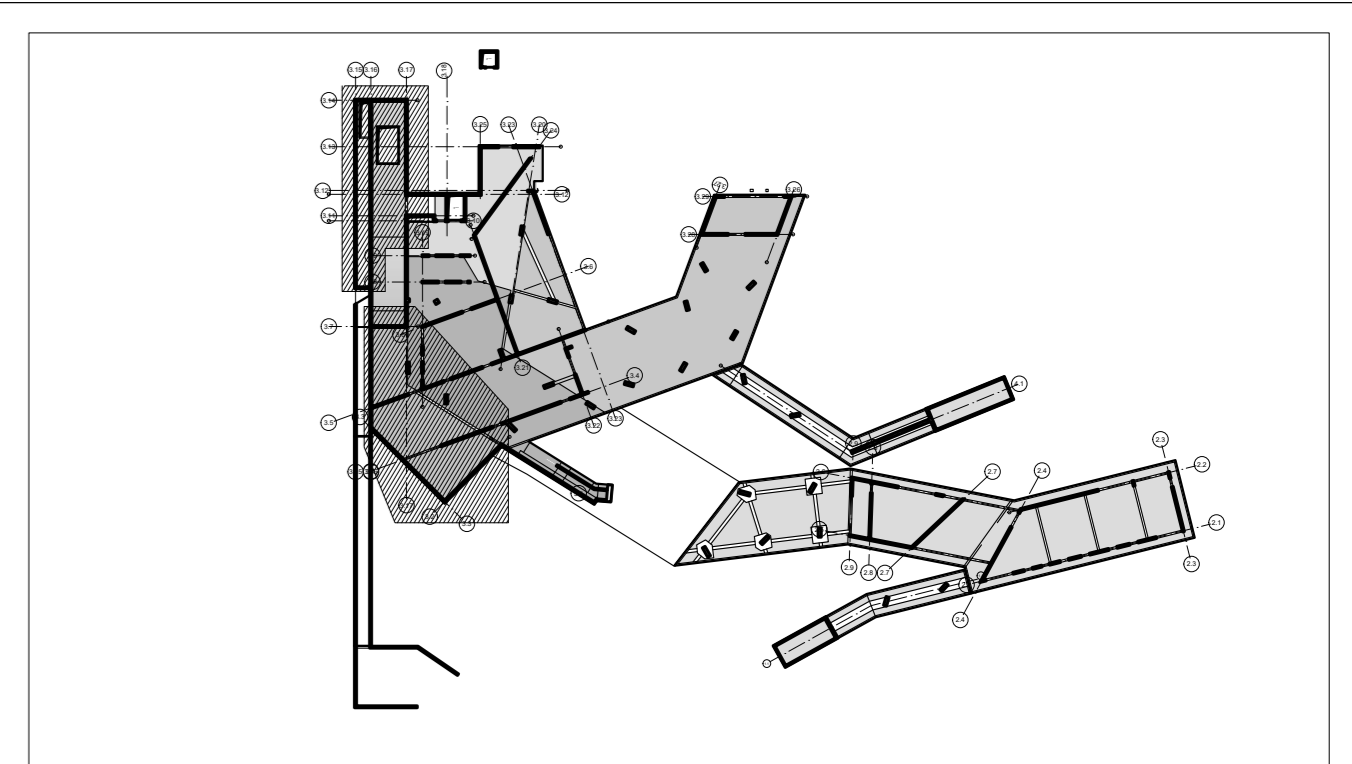

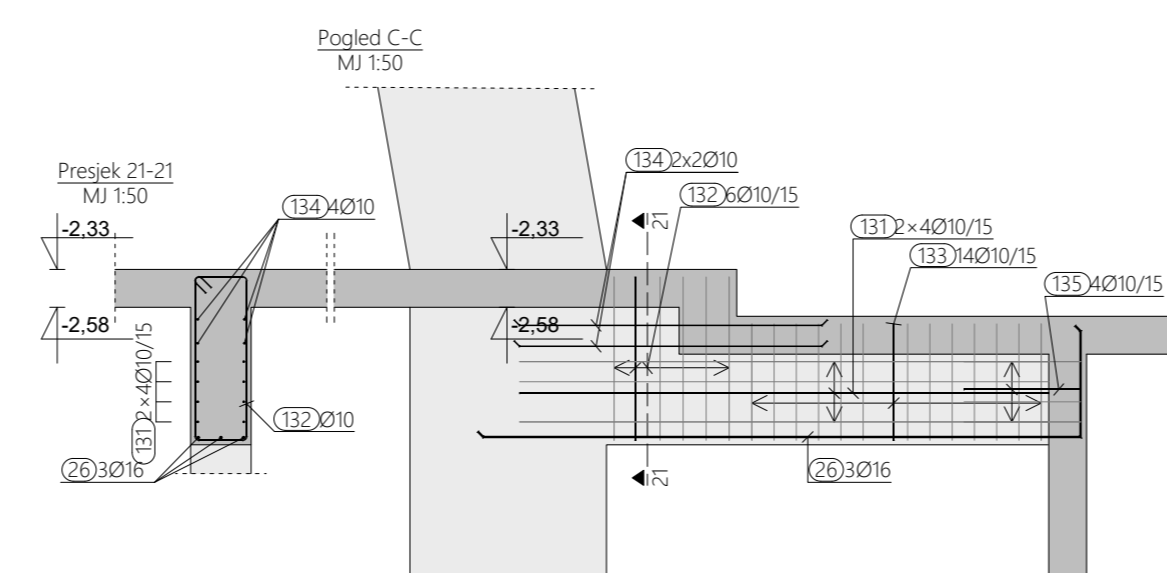
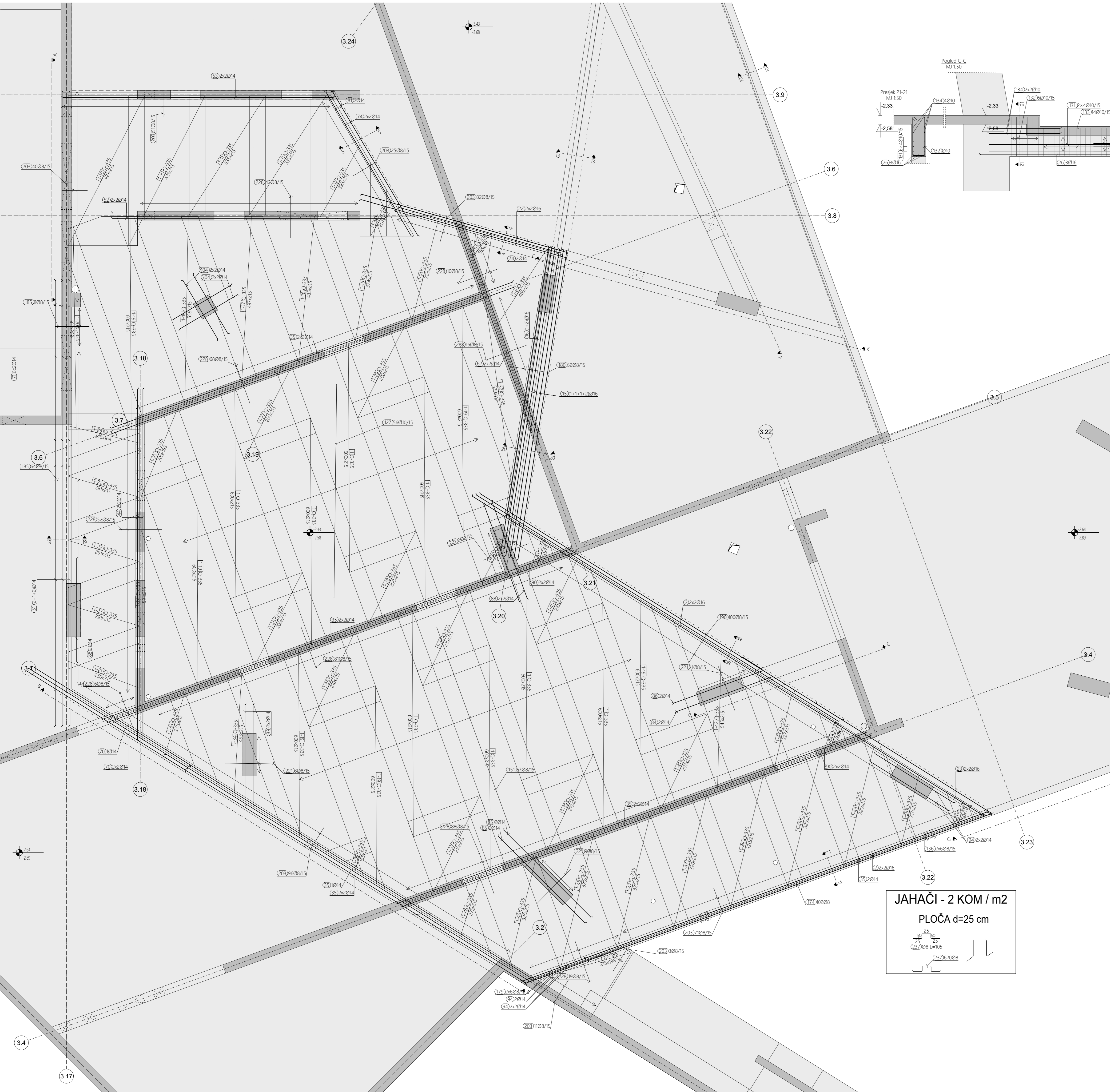

JAHAČI - 2 KOM / m²
PLOČA d=25 cm

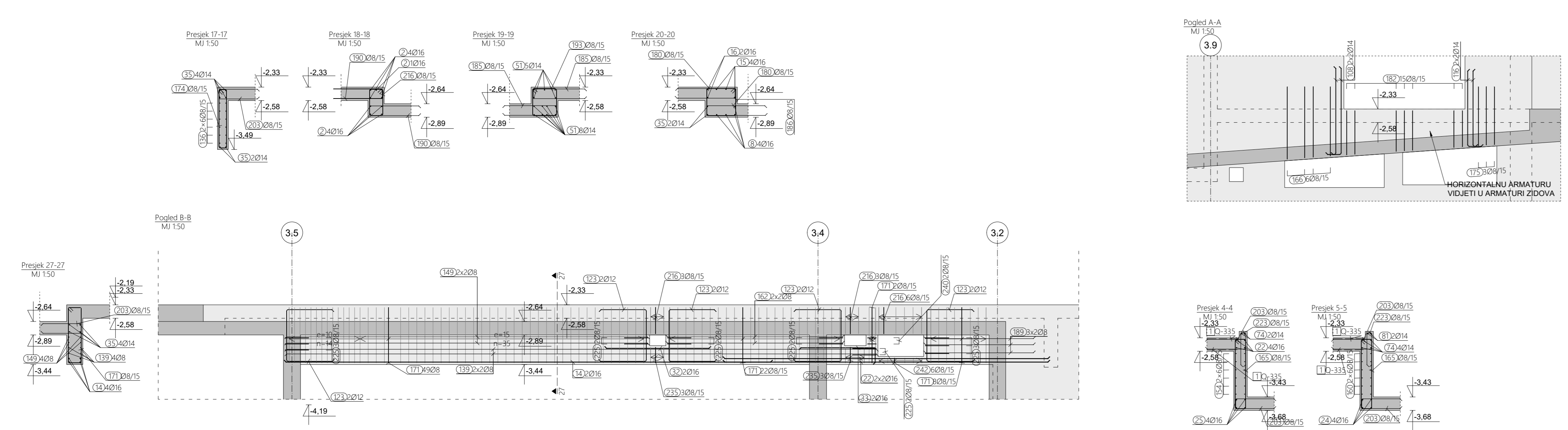

Redni broj	Šifra	Opis	Visina (cm)	Debljina (cm)	Udaljenost od ruba (cm)	Udaljenost od ruba (cm)	Udaljenost od ruba (cm)	Udaljenost od ruba (cm)	Udaljenost od ruba (cm)
1	100	100	4.00	4.00	4.00	4.00	4.00	4.00	4.00
2	100	100	4.00	4.00	4.00	4.00	4.00	4.00	4.00
3	100	100	4.00	4.00	4.00	4.00	4.00	4.00	4.00
4	100	100	4.00	4.00	4.00	4.00	4.00	4.00	4.00
5	100	100	4.00	4.00	4.00	4.00	4.00	4.00	4.00
6	100	100	4.00	4.00	4.00	4.00	4.00	4.00	4.00
7	100	100	4.00	4.00	4.00	4.00	4.00	4.00	4.00
8	100	100	4.00	4.00	4.00	4.00	4.00	4.00	4.00
9	100	100	4.00	4.00	4.00	4.00	4.00	4.00	4.00
10	100	100	4.00	4.00	4.00	4.00	4.00	4.00	4.00
11	100	100	4.00	4.00	4.00	4.00	4.00	4.00	4.00
12	100	100	4.00	4.00	4.00	4.00	4.00	4.00	4.00
13	100	100	4.00	4.00	4.00	4.00	4.00	4.00	4.00
14	100	100	4.00	4.00	4.00	4.00	4.00	4.00	4.00
15	100	100	4.00	4.00	4.00	4.00	4.00	4.00	4.00
16	100	100	4.00	4.00	4.00	4.00	4.00	4.00	4.00
17	100	100	4.00	4.00	4.00	4.00	4.00	4.00	4.00
18	100	100	4.00	4.00	4.00	4.00	4.00	4.00	4.00
19	100	100	4.00	4.00	4.00	4.00	4.00	4.00	4.00
20	100	100	4.00	4.00	4.00	4.00	4.00	4.00	4.00
21	100	100	4.00	4.00	4.00	4.00	4.00	4.00	4.00
22	100	100	4.00	4.00	4.00	4.00	4.00	4.00	4.00
23	100	100	4.00	4.00	4.00	4.00	4.00	4.00	4.00
24	100	100	4.00	4.00	4.00	4.00	4.00	4.00	4.00
25	100	100	4.00	4.00	4.00	4.00	4.00	4.00	4.00
26	100	100	4.00	4.00	4.00	4.00	4.00	4.00	4.00
27	100	100	4.00	4.00	4.00	4.00	4.00	4.00	4.00
28	100	100	4.00	4.00	4.00	4.00	4.00	4.00	4.00
29	100	100	4.00	4.00	4.00	4.00	4.00	4.00	4.00
30	100	100	4.00	4.00	4.00	4.00	4.00	4.00	4.00
31	100	100	4.00	4.00	4.00	4.00	4.00	4.00	4.00
32	100	100	4.00	4.00	4.00	4.00	4.00	4.00	4.00
33	100	100	4.00	4.00	4.00	4.00	4.00	4.00	4.00
34	100	100	4.00	4.00	4.00	4.00	4.00	4.00	4.00
35	100	100	4.00	4.00	4.00	4.00	4.00	4.00	4.00
36	100	100	4.00	4.00	4.00	4.00	4.00	4.00	4.00
37	100	100	4.00	4.00	4.00	4.00	4.00	4.00	4.00
38	100	100	4.00	4.00	4.00	4.00	4.00	4.00	4.00
39	100	100	4.00	4.00	4.00	4.00	4.00	4.00	4.00
40	100	100	4.00	4.00	4.00	4.00	4.00	4.00	4.00
41	100	100	4.00	4.00	4.00	4.00	4.00	4.00	4.00
42	100	100	4.00	4.00	4.00	4.00	4.00	4.00	4.00
43	100	100	4.00	4.00	4.00	4.00	4.00	4.00	4.00
44	100	100	4.00	4.00	4.00	4.00	4.00	4.00	4.00
45	100	100	4.00	4.00	4.00	4.00	4.00	4.00	4.00
46	100	100	4.00	4.00	4.00	4.00	4.00	4.00	4.00
47	100	100	4.00	4.00	4.00	4.00	4.00	4.00	4.00
48	100	100	4.00	4.00	4.00	4.00	4.00	4.00	4.00
49	100	100	4.00	4.00	4.00	4.00	4.00	4.00	4.00
50	100	100	4.00	4.00	4.00	4.00	4.00	4.00	4.00
51	100	100	4.00	4.00	4.00	4.00	4.00	4.00	4.00
52	100	100	4.00	4.00	4.00	4.00	4.00	4.00	4.00
53	100	100	4.00	4.00	4.00	4.00	4.00	4.00	4.00
54	100	100	4.00	4.00	4.00	4.00	4.00	4.00	4.00
55	100	100	4.00	4.00	4.00	4.00	4.00	4.00	4.00
56	100	100	4.00	4.00	4.00	4.00	4.00	4.00	4.00
57	100	100	4.00	4.00	4.00	4.00	4.00	4.00	4.00
58	100	100	4.00	4.00	4.00	4.00	4.00	4.00	4.00
59	100	100	4.00	4.00	4.00	4.00	4.00	4.00	4.00
60	100	100	4.00	4.00	4.00	4.00	4.00	4.00	4.00
61	100	100	4.00	4.00	4.00	4.00	4.00	4.00	4.00
62	100	100	4.00	4.00	4.00	4.00	4.00	4.00	4.00
63	100	100	4.00	4.00	4.00	4.00	4.00	4.00	4.00
64	100	100	4.00	4.00	4.00	4.00	4.00	4.00	4.00
65	100	100	4.00	4.00	4.00	4.00	4.00	4.00	4.00
66	100	100	4.00	4.00	4.00	4.00	4.00	4.00	4.00
67	100	100	4.00	4.00	4.00	4.00	4.00	4.00	4.00
68	100	100	4.00	4.00	4.00	4.00	4.00	4.00	4.00
69	100	100	4.00	4.00	4.00	4.00	4.00	4.00	4.00
70	100	100	4.00	4.00	4.00	4.00	4.00	4.00	4.00
71	100	100	4.00	4.00	4.00	4.00	4.00	4.00	4.00
72	100	100	4.00	4.00	4.00	4.00	4.00	4.00	4.00
73	100	100	4.00	4.00	4.00	4.00	4.00	4.00	4.00
74	100	100	4.00	4.00	4.00	4.00	4.00	4.00	4.00
75	100	100	4.00	4.00	4.00	4.00	4.00	4.00	4.00
76	100	100	4.00	4.00	4.00	4.00	4.00	4.00	4.00
77	100	100	4.00	4.00	4.00	4.00	4.00	4.00	4.00
78	100	100	4.00	4.00	4.00	4.00	4.00	4.00	4.00
79	100	100	4.00	4.00	4.00	4.00	4.00	4.00	4.00
80	100	100	4.00	4.00	4.00	4.00	4.00	4.00	4.00
81	100	100	4.00	4.00	4.00	4.00	4.00	4.00	4.00
82	100	100	4.00	4.00	4.00	4.00	4.00	4.00	4.00
83	100	100	4.00	4.00	4.00	4.00	4.00	4.00	4.00
84	100	100	4.00	4.00	4.00	4.00	4.00	4.00	4.00
85	100	100	4.00	4.00	4.00	4.00	4.00	4.00	4.00
86	100	100	4.00	4.00	4.00	4.00	4.00	4.00	4.00
87	100	100	4.00	4.00	4.00	4.00	4.00	4.00	4.00
88	100	100	4.00	4.00	4.00	4.00	4.00	4.00	4.00
89	100	100	4.00	4.00	4.00	4.00	4.00	4.00	4.00
90	100	100	4.00	4.00	4.00	4.00	4.00	4.00	4.00
91	100	100	4.00	4.00	4.00	4.00	4.00	4.00	4.00
92	100	100	4.00	4.00	4.00	4.00	4.00	4.00	4.00
93	100	100	4.00	4.00	4.00	4.00	4.00	4.00	4.00
94	100	100	4.00	4.00	4.00	4.00	4.00	4.00	4.00
95	100	100	4.00	4.00	4.00	4.00	4.00	4.00	4.00
96	100	100	4.00	4.00	4.00	4.00	4.00	4.00	4.00
97	100	100	4.00	4.00	4.00	4.00	4.00	4.00	4.00
98	100	100	4.00	4.00	4.00	4.00	4.00	4.00	4.00
99	100	100	4.00	4.00	4.00	4.00	4.00	4.00	4.00
100	100	100	4.00	4.00	4.00	4.00	4.00	4.00	4.00

NAPOMENA
Šipke prilagoditi i po potrebi rezati na licu mjesta. Preklap 500.

NAPOMENA
Sve dimenzije provjeriti prema važećim planovima oplate.

Klasa betona		C 30/37	
Armatura		B 500 B	
Zaštitni sloj betona			
dođe	gore	bočno	Pripadajuća lista armature: ARM_E-2_301-308_ISKAZ
3,0 cm	3,0 cm	3,0 cm	
Pripadajući armaturni nacrti			
ARM_E-2_301-302_304-308			
ARM_E-2_321			

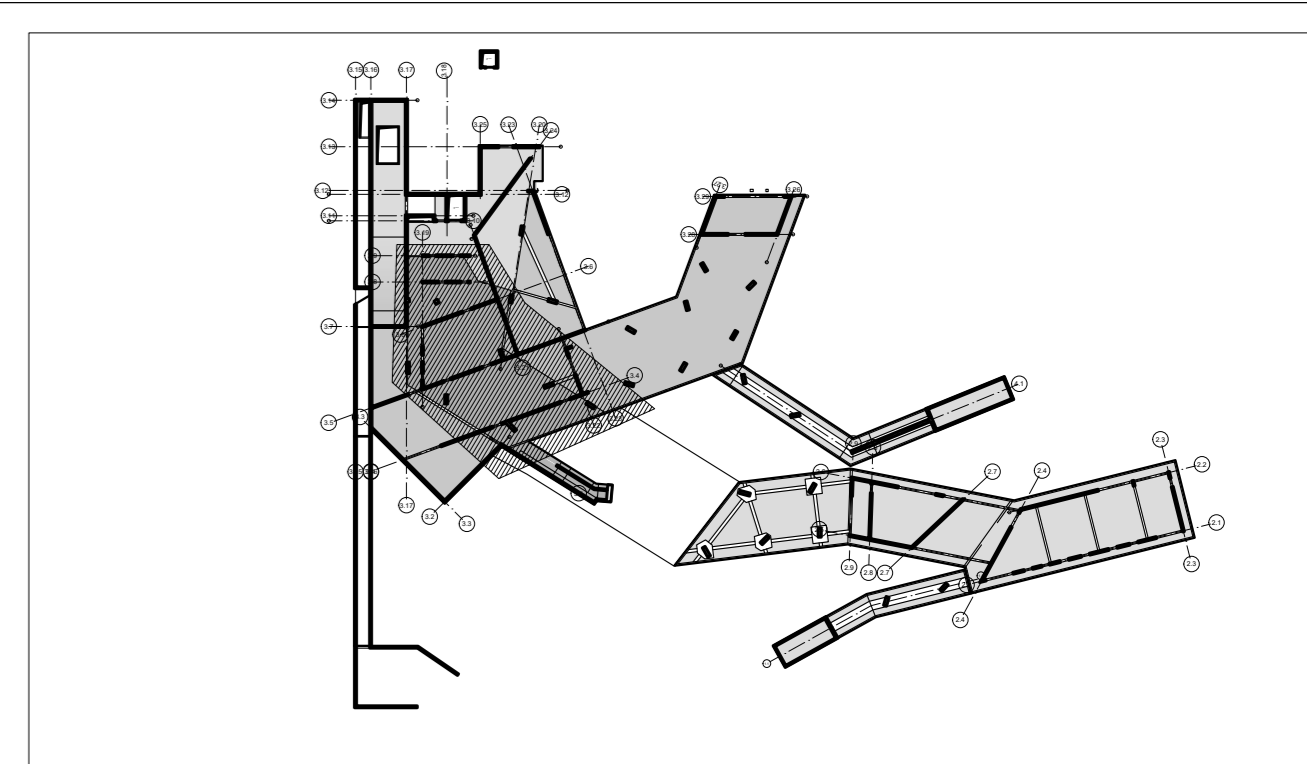

KONSTRUKTA	PEČAT I POTPIŠ:	
KONSTRUKTA d.o.o., za projektiranje i nadzor Bavarska 26, ZAGREB, OIB: 0667437079 ŽR: PRIVREDNA BANKA 2340009-110164468 TEL: 0136 43 826; FAX: 0136 43 829 MAIL: info@konstrukt.hr	GL. PROJEKTANT: Tomislav Vrh, dipl. ing. arh.	
INVESTITOR: TERME TUNJEV I d.o.o. Ljudekova Gajeva 4, Tunjevske Toplice, 48115 Tunje	PROJEKT IZV. PR: Antonio Maglov, dipl. ing. grad.	
GRAĐEVINA: REKONSTRUKCIJA TERMALNOG REKREACIJSKOG CENTRA TERME TUNJEV I	IZRADIO: Antonio Maglov, dipl. ing. grad.	
LOKACIJA: na k. b. br. 3199/1, k. o. Črednjevec	DATUM: septem. 2023.	
FAZA: IZVODENI PROJEKT - ARMATURNI NACRTI	MAJERLO: 1:50 1:25 REVIZIJA: 00	
ŠARŽAR: ELEMENT - PLOČA E-2	NACRT BR: ARM - E-2 - 303	
DILATACIJA 3		
RUB. ARMATURA I DONJA ZONA		

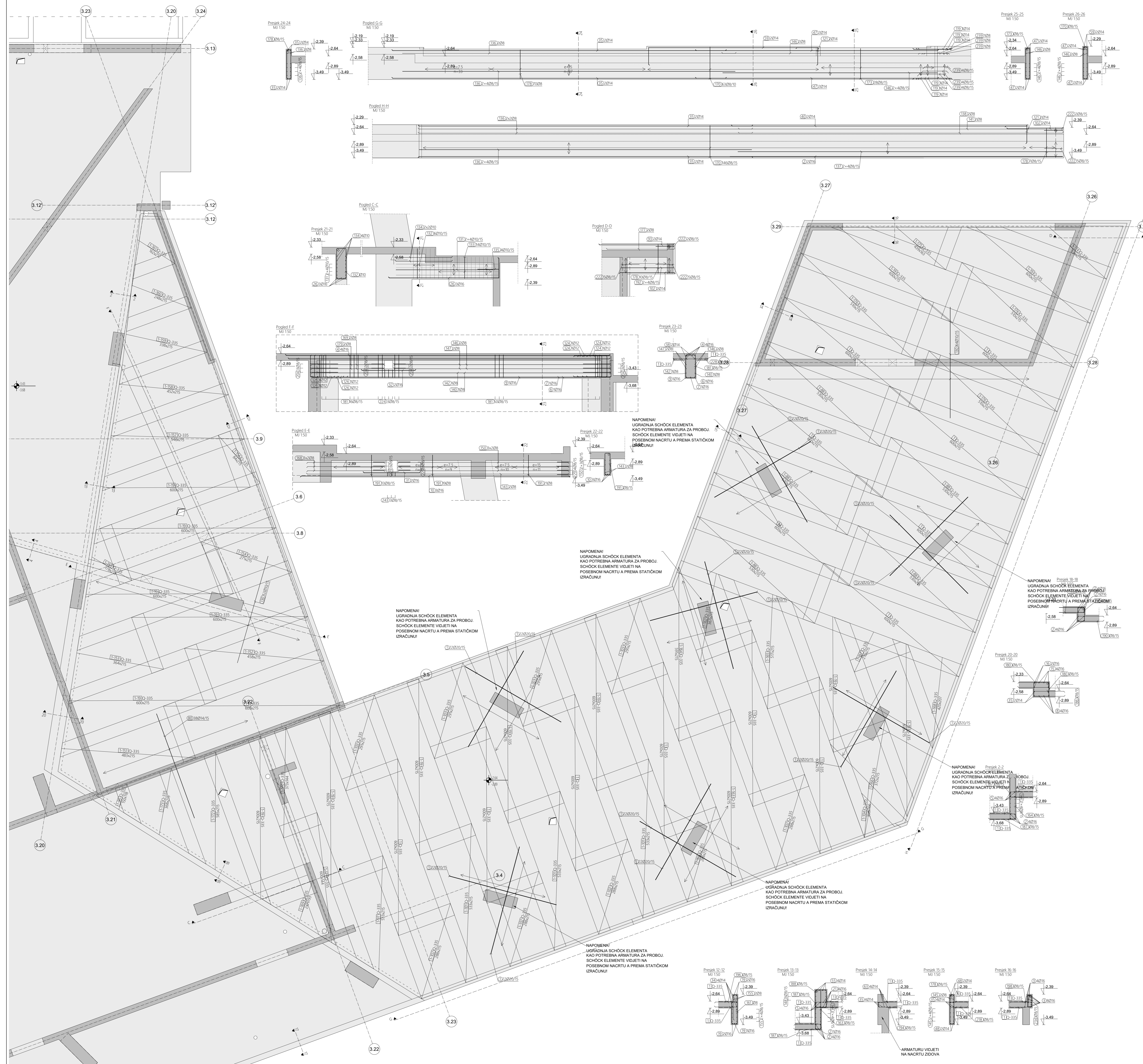

Tab. - op. lista

Red. br.	Opis	Ukupno	Ukupno	Ukupno
1	Ø10/200	408	150	408
2	Ø12/100	10	35	10
3	Ø10/200	10	35	10
4	Ø10/200	10	35	10
5	Ø10/200	10	35	10
6	Ø10/200	10	35	10
7	Ø10/200	10	35	10
8	Ø10/200	10	35	10
9	Ø10/200	10	35	10
10	Ø10/200	10	35	10
11	Ø10/200	10	35	10
12	Ø10/200	10	35	10
13	Ø10/200	10	35	10
14	Ø10/200	10	35	10
15	Ø10/200	10	35	10
16	Ø10/200	10	35	10
17	Ø10/200	10	35	10
18	Ø10/200	10	35	10
19	Ø10/200	10	35	10
20	Ø10/200	10	35	10
21	Ø10/200	10	35	10
22	Ø10/200	10	35	10
23	Ø10/200	10	35	10
24	Ø10/200	10	35	10
25	Ø10/200	10	35	10
26	Ø10/200	10	35	10
27	Ø10/200	10	35	10
28	Ø10/200	10	35	10
29	Ø10/200	10	35	10
30	Ø10/200	10	35	10
31	Ø10/200	10	35	10
32	Ø10/200	10	35	10
33	Ø10/200	10	35	10
34	Ø10/200	10	35	10
35	Ø10/200	10	35	10
36	Ø10/200	10	35	10
37	Ø10/200	10	35	10
38	Ø10/200	10	35	10
39	Ø10/200	10	35	10
40	Ø10/200	10	35	10

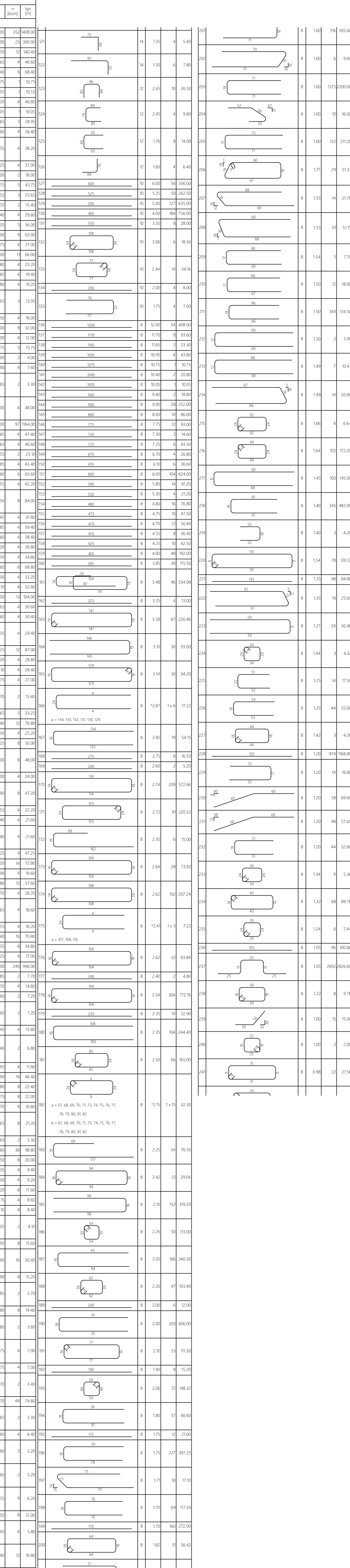

NAPOMENA
Šipke prilagoditi po potrebi rezati na licu mjesta. Preklap 50%.

NAPOMENA
Sve dimenzije provjeriti prema važećim planovima optate.

Klasa betona	C 30/37				
Armatura	B 500 B				
Zaštitni sloj betona	Preporučena faza armature: ARM_E-2_301-308_ISKAZ				
dođe	gore	bočno	3,0 cm	3,0 cm	3,0 cm
Prilagodljivi armaturni nacrti					
ARM_E-2_301-304_306-308					
ARM_E-2_321					

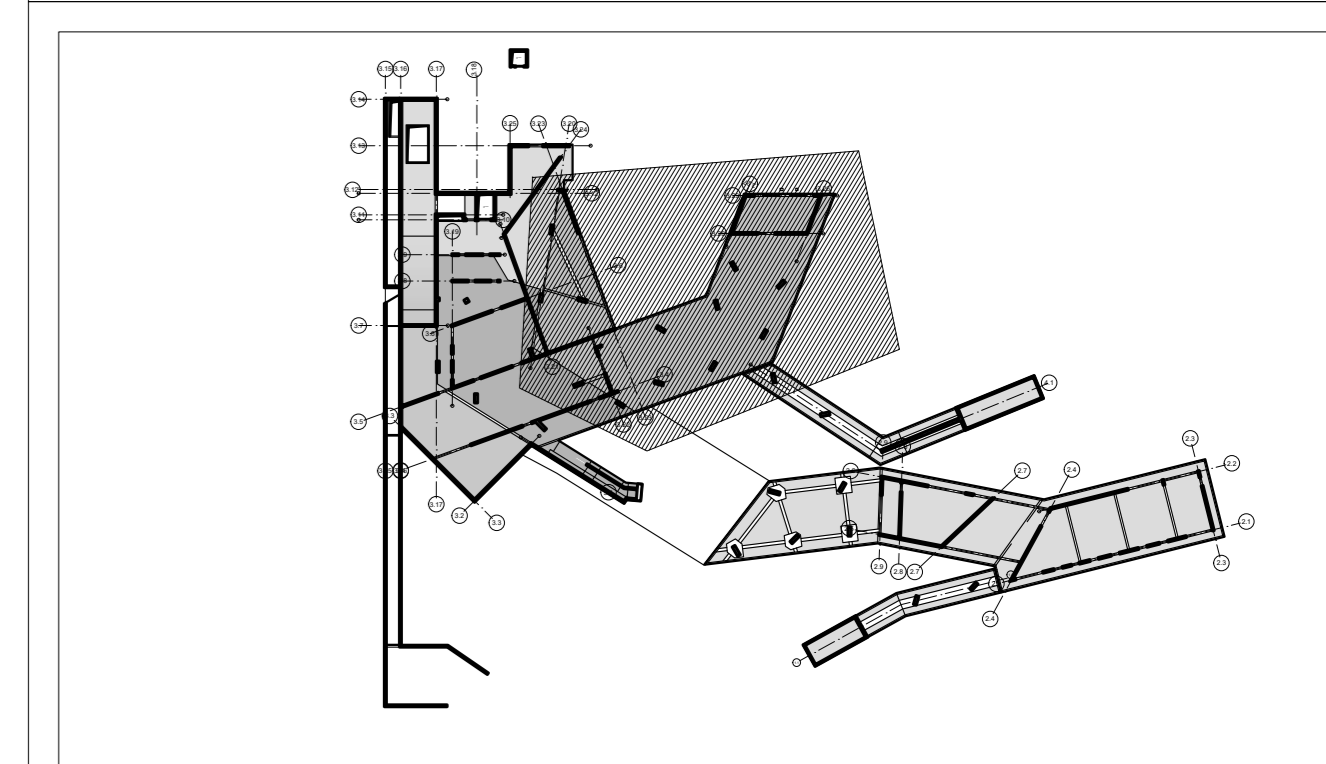

KONSTRUKTA PEČAT I POTIS

KONSTRUKTA d.o.o. - za projektiranje i nadzor
Desimka 29, ZA GREB, OIB: 0667437579
Zr: PRIVREDNA BANKA 2340000-111014468
TEL: 01196 43 828; FAX: 01196 43 829
MAIL: info@konstrukta.hr

INVESTITOR: TERME TUNJEVI d.o.o. Ujdojna Gopa 4, Tunjevi Topolci, 88212 Tunjevi

GL. PROJEKTANT: Tomislav Vest, dipl. ing. arh.

GRAĐEVINA: REKONSTRUKCIJA TERMALENOG REKREACIJSKOG CENTRA TERME TUNJEVI

PROJEKT. LEV. PR: Arđino Magdo, dipl. ing. graf.

IZRAČAK: Arđino Magdo, dipl. ing. graf.

LOKACIJA: na k.č.br. 3199/1, k.o. Črešnjevec

DATUM: 19.09.2023.

FAZ: IZVEDBENI PROJEKT - ARMATURNI NACRTI

MIERLO: 1:50; 1:25; REVOLUCIJA: 00

SADRŽAJ: ELEMENT - PLOČA E-2

NACRT BR: ARM - E-2 - 305

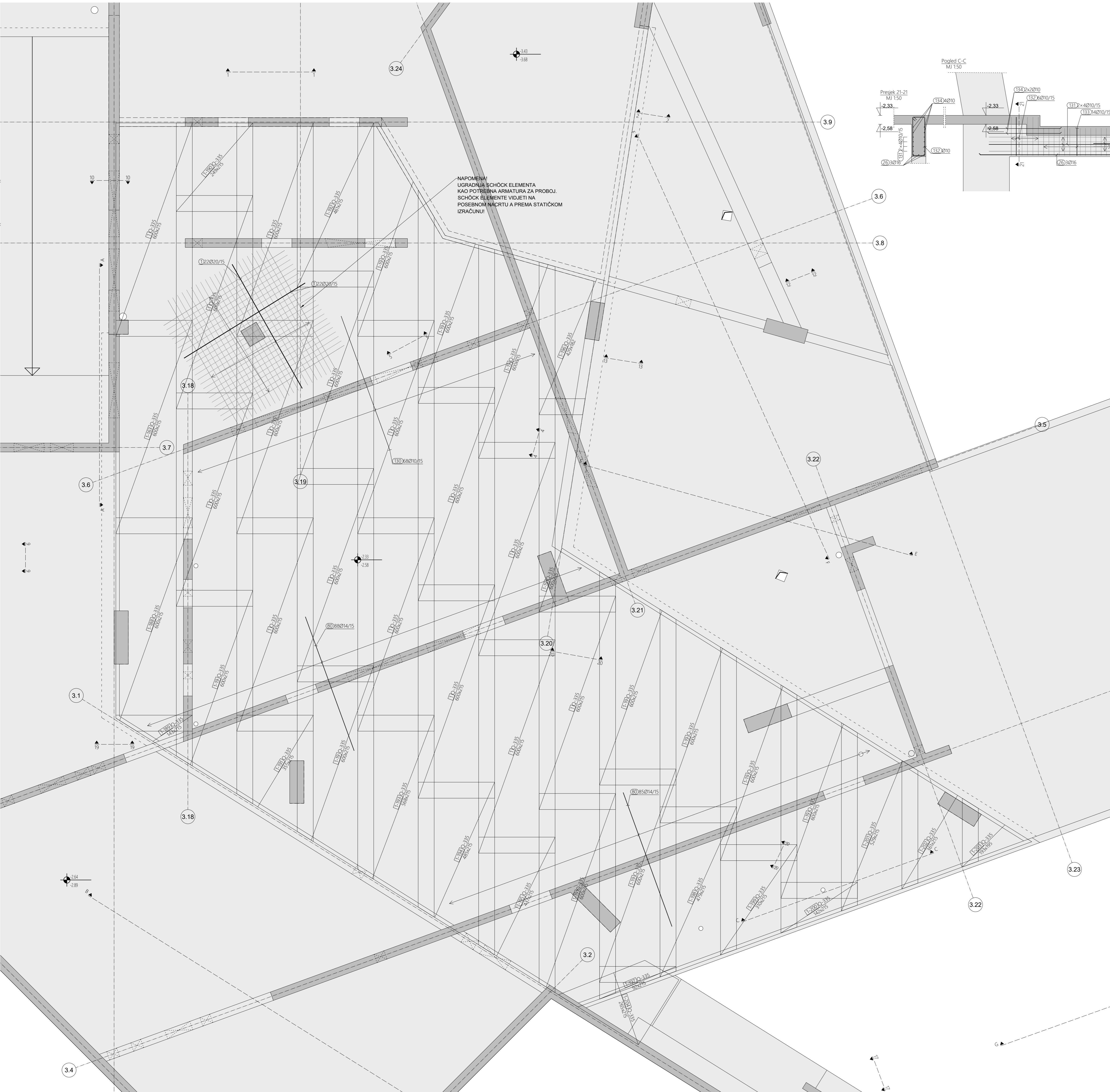

NAPOMENA
UGRADNJA ŠCOKIČK ELEMENTA
KAO POTREBNA ARMATURA ZA PROBUJ.
ŠCOKIČK ELEMENTE VIDJETI NA
POSEBNOJ MORTU A PREMA STATIONOM
IZRAZUJUI

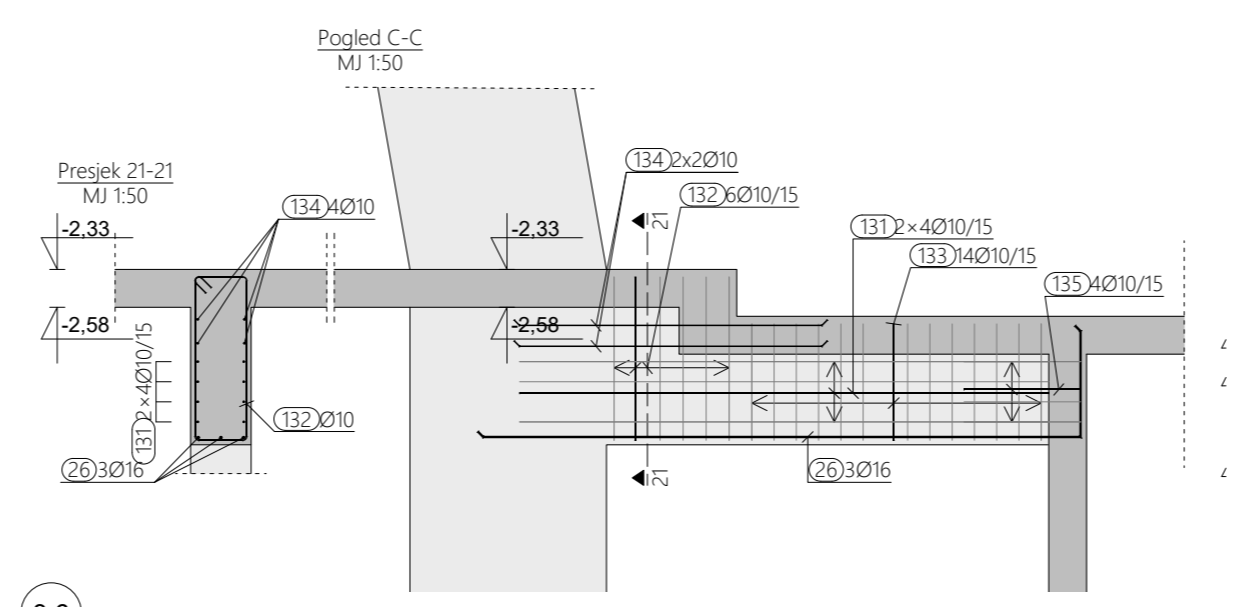

Šifra	Opis	Šifra	Opis	Šifra	Opis
1	Ø12	101	Ø12	191	Ø12
2	Ø12	102	Ø12	192	Ø12
3	Ø12	103	Ø12	193	Ø12
4	Ø12	104	Ø12	194	Ø12
5	Ø12	105	Ø12	195	Ø12
6	Ø12	106	Ø12	196	Ø12
7	Ø12	107	Ø12	197	Ø12
8	Ø12	108	Ø12	198	Ø12
9	Ø12	109	Ø12	199	Ø12
10	Ø12	110	Ø12	200	Ø12
11	Ø12	111	Ø12	201	Ø12
12	Ø12	112	Ø12	202	Ø12
13	Ø12	113	Ø12	203	Ø12
14	Ø12	114	Ø12	204	Ø12
15	Ø12	115	Ø12	205	Ø12
16	Ø12	116	Ø12	206	Ø12
17	Ø12	117	Ø12	207	Ø12
18	Ø12	118	Ø12	208	Ø12
19	Ø12	119	Ø12	209	Ø12
20	Ø12	120	Ø12	210	Ø12
21	Ø12	121	Ø12	211	Ø12
22	Ø12	122	Ø12	212	Ø12
23	Ø12	123	Ø12	213	Ø12
24	Ø12	124	Ø12	214	Ø12
25	Ø12	125	Ø12	215	Ø12
26	Ø12	126	Ø12	216	Ø12
27	Ø12	127	Ø12	217	Ø12
28	Ø12	128	Ø12	218	Ø12
29	Ø12	129	Ø12	219	Ø12
30	Ø12	130	Ø12	220	Ø12
31	Ø12	131	Ø12	221	Ø12
32	Ø12	132	Ø12	222	Ø12
33	Ø12	133	Ø12	223	Ø12
34	Ø12	134	Ø12	224	Ø12
35	Ø12	135	Ø12	225	Ø12
36	Ø12	136	Ø12	226	Ø12
37	Ø12	137	Ø12	227	Ø12
38	Ø12	138	Ø12	228	Ø12
39	Ø12	139	Ø12	229	Ø12
40	Ø12	140	Ø12	230	Ø12
41	Ø12	141	Ø12	231	Ø12
42	Ø12	142	Ø12	232	Ø12
43	Ø12	143	Ø12	233	Ø12
44	Ø12	144	Ø12	234	Ø12
45	Ø12	145	Ø12	235	Ø12
46	Ø12	146	Ø12	236	Ø12
47	Ø12	147	Ø12	237	Ø12
48	Ø12	148	Ø12	238	Ø12
49	Ø12	149	Ø12	239	Ø12
50	Ø12	150	Ø12	240	Ø12
51	Ø12	151	Ø12	241	Ø12
52	Ø12	152	Ø12	242	Ø12
53	Ø12	153	Ø12	243	Ø12
54	Ø12	154	Ø12	244	Ø12
55	Ø12	155	Ø12	245	Ø12
56	Ø12	156	Ø12	246	Ø12
57	Ø12	157	Ø12	247	Ø12
58	Ø12	158	Ø12	248	Ø12
59	Ø12	159	Ø12	249	Ø12
60	Ø12	160	Ø12	250	Ø12
61	Ø12	161	Ø12	251	Ø12
62	Ø12	162	Ø12	252	Ø12
63	Ø12	163	Ø12	253	Ø12
64	Ø12	164	Ø12	254	Ø12
65	Ø12	165	Ø12	255	Ø12
66	Ø12	166	Ø12	256	Ø12
67	Ø12	167	Ø12	257	Ø12
68	Ø12	168	Ø12	258	Ø12
69	Ø12	169	Ø12	259	Ø12
70	Ø12	170	Ø12	260	Ø12
71	Ø12	171	Ø12	261	Ø12
72	Ø12	172	Ø12	262	Ø12
73	Ø12	173	Ø12	263	Ø12
74	Ø12	174	Ø12	264	Ø12
75	Ø12	175	Ø12	265	Ø12
76	Ø12	176	Ø12	266	Ø12
77	Ø12	177	Ø12	267	Ø12
78	Ø12	178	Ø12	268	Ø12
79	Ø12	179	Ø12	269	Ø12
80	Ø12	180	Ø12	270	Ø12
81	Ø12	181	Ø12	271	Ø12
82	Ø12	182	Ø12	272	Ø12
83	Ø12	183	Ø12	273	Ø12
84	Ø12	184	Ø12	274	Ø12
85	Ø12	185	Ø12	275	Ø12
86	Ø12	186	Ø12	276	Ø12
87	Ø12	187	Ø12	277	Ø12
88	Ø12	188	Ø12	278	Ø12
89	Ø12	189	Ø12	279	Ø12
90	Ø12	190	Ø12	280	Ø12
91	Ø12	191	Ø12	281	Ø12
92	Ø12	192	Ø12	282	Ø12
93	Ø12	193	Ø12	283	Ø12
94	Ø12	194	Ø12	284	Ø12
95	Ø12	195	Ø12	285	Ø12
96	Ø12	196	Ø12	286	Ø12
97	Ø12	197	Ø12	287	Ø12
98	Ø12	198	Ø12	288	Ø12
99	Ø12	199	Ø12	289	Ø12
100	Ø12	200	Ø12	290	Ø12
101	Ø12	201	Ø12	291	Ø12
102	Ø12	202	Ø12	292	Ø12
103	Ø12	203	Ø12	293	Ø12
104	Ø12	204	Ø12	294	Ø12
105	Ø12	205	Ø12	295	Ø12
106	Ø12	206	Ø12	296	Ø12
107	Ø12	207	Ø12	297	Ø12
108	Ø12	208	Ø12	298	Ø12
109	Ø12	209	Ø12	299	Ø12
110	Ø12	210	Ø12	300	Ø12

NAPOMENA
Šipke prilagoditi i po potrebi rezati
na licu mjesta. Preklap 500.

NAPOMENA
Sve dimenzije provjeriti prema
važićim planovima oplata.

Klasa betona	C 30/37
Armatura	B 500 B
Zaštitni sloj betona	
dođe	3.0 cm
gore	3.0 cm
bočno	3.0 cm
Pripadajući armaturni nacrti	ARM_E-2_301-306_ISKAZ
ARM_E-2_301-306_308	
ARM_E-2_321	

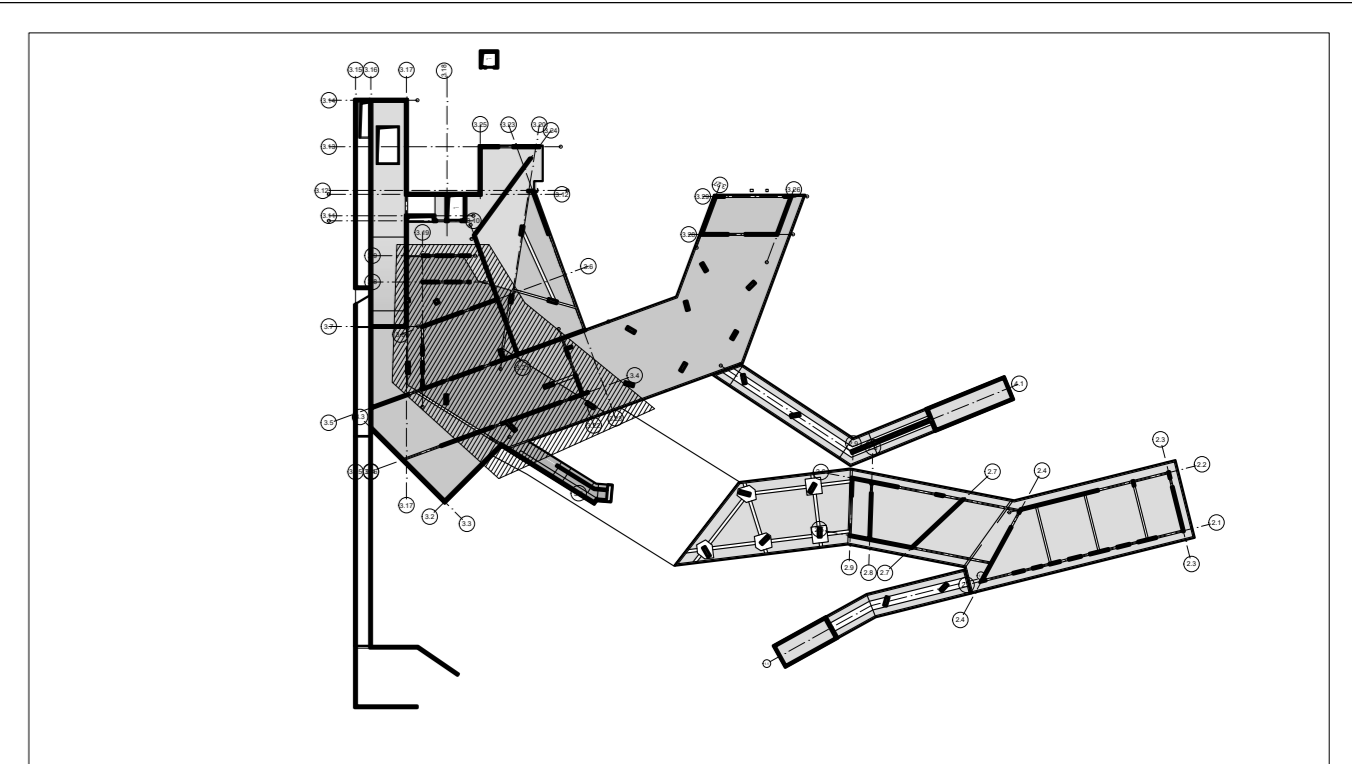

KONSTRUKTA PEČAT I POTPIŠ

KONSTRUKTA d.o.o., za projektiranje i nadzor
Bosanska 26, ZAGREB, OIB: 0667437079
ŽR: PRIVREDNA BANKA 2340009-110164468
TEL: 0136 43 826; FAX: 0136 43 829
MAIL: info@konstrukt.hr

INVESTITOR: TERASE TUHELJ d.o.o., Ljudekova Gaj 4, Tuhejske Toplice, 49215 Tuhej
GRADJEVINA: REKONSTRUKCIJA TERASNOG HEBERACIJSKOG CENTRA TERASE TUHELJ
LOKACIJA: na k.č.br. 3199/1, k.o. Črednjevec
FAZA: IZVEDBENI PROJEKT - ARMATURNI NACRTI
54042A2: ELEMENT - PLOČA E-2 DILATACIJA 3 ARMATURA GORNJE ZONE

GL. PROJEKTANT: Tomislav Vrh, dipl. ing. arh.
PROJEKT. IZV. PR: Antonio Maglov, dipl. ing. grad.
IZRAĐIO: Antonio Maglov, dipl. ing. grad.

DATUM: septem, 2023.
MAJERLO: 1:50, 1:25
REVIZIJA: 00
ARM - E-2 - 307

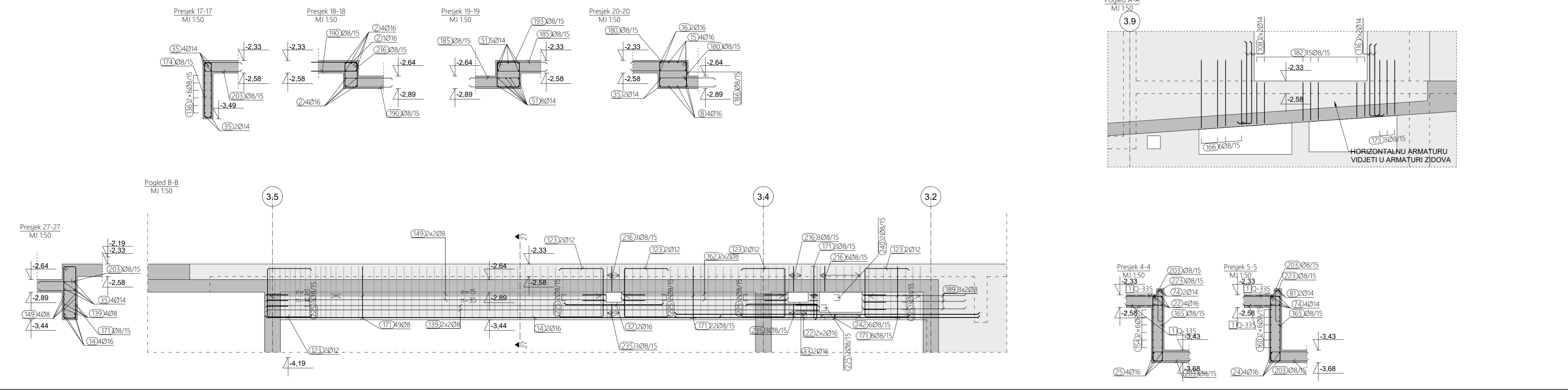

ARMATURA GORNJE ZONE, PLOČA NA VISINSKOJ KOTI -5.59/-5.84, M 1:50

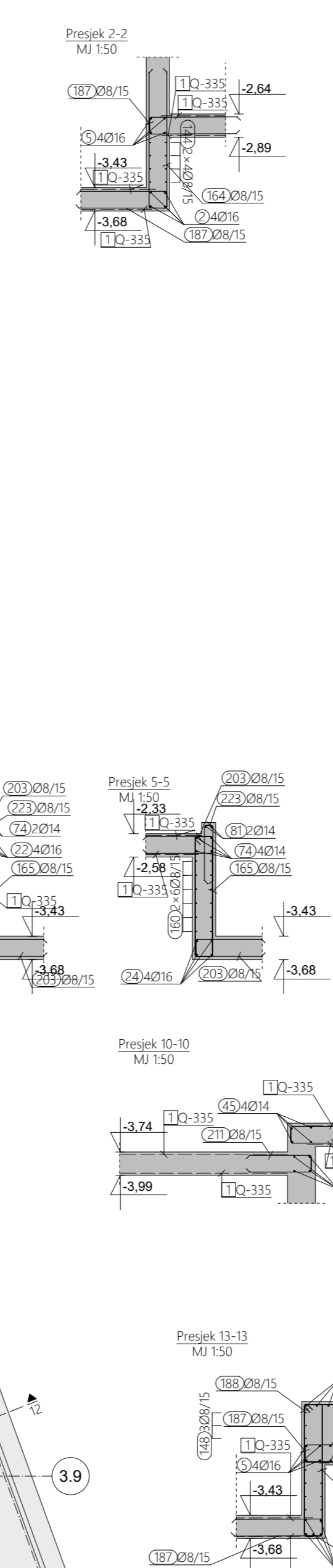
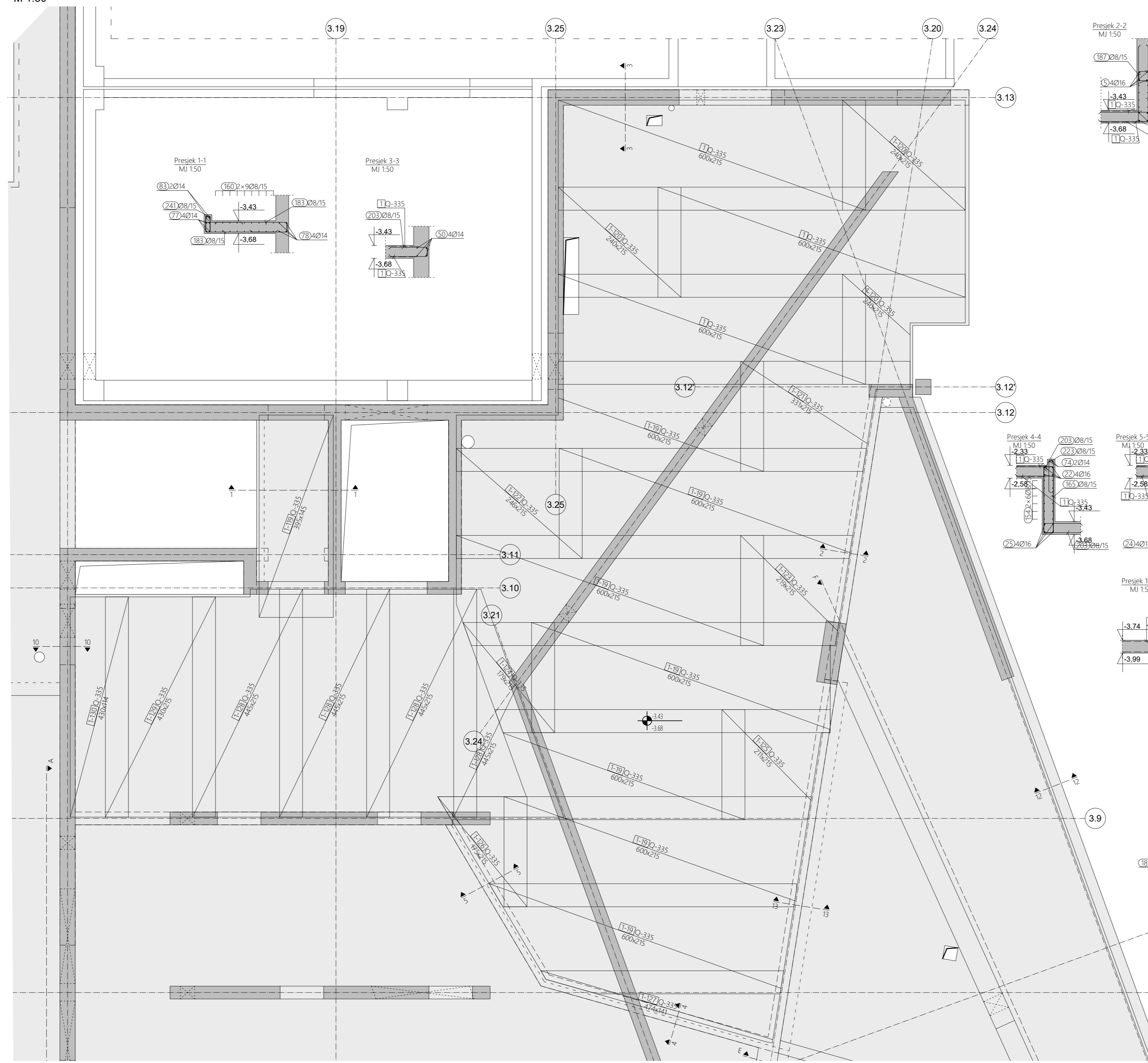
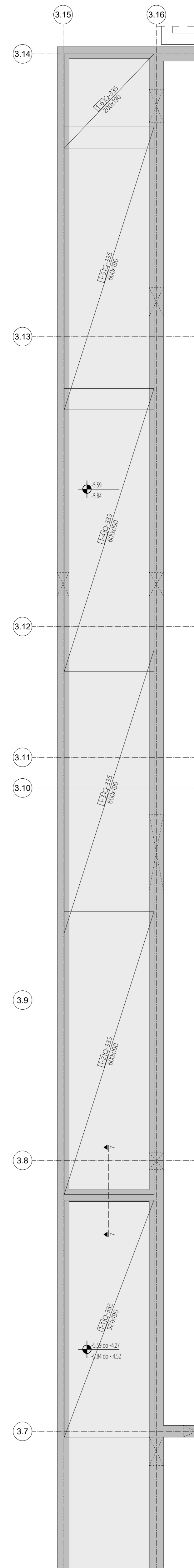

ARMATURA GORNJE ZONE, PLOČA NA VISINSKOJ KOTI -4.27/-4.52, M 1:50

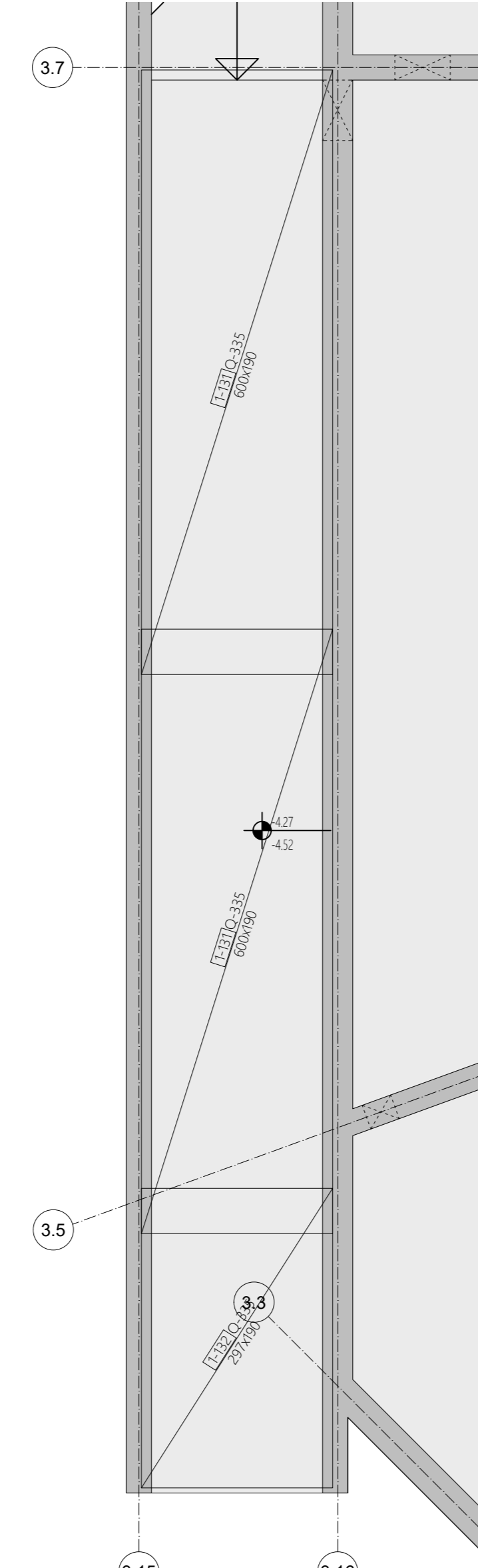

ARMATURA GORNJE ZONE, PLOČA NA VISINI -3.33 do -2.64/-2.89, M 1:50

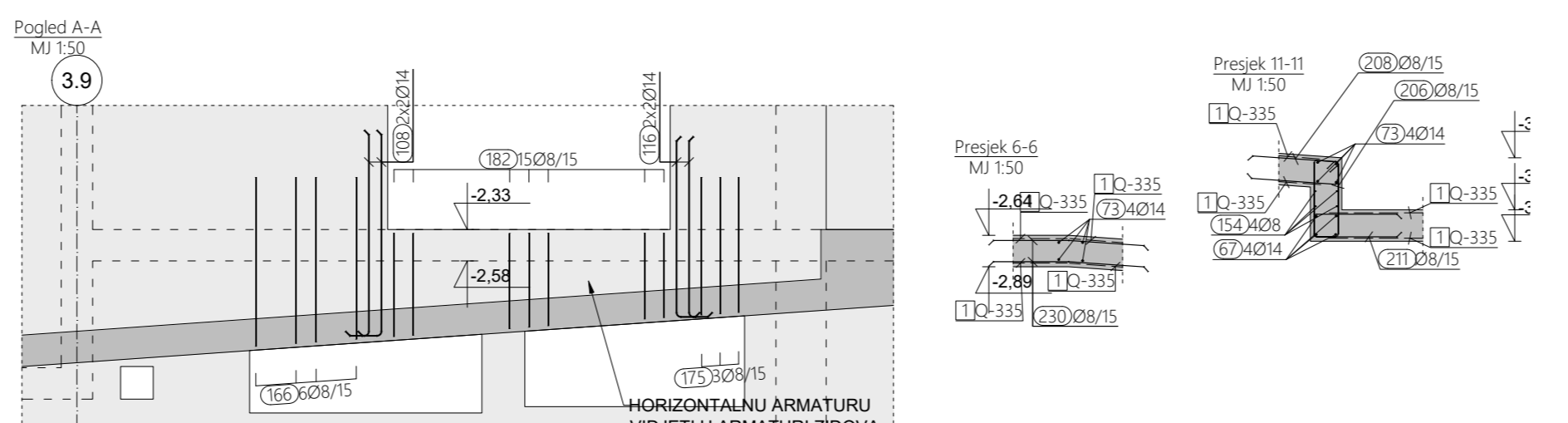
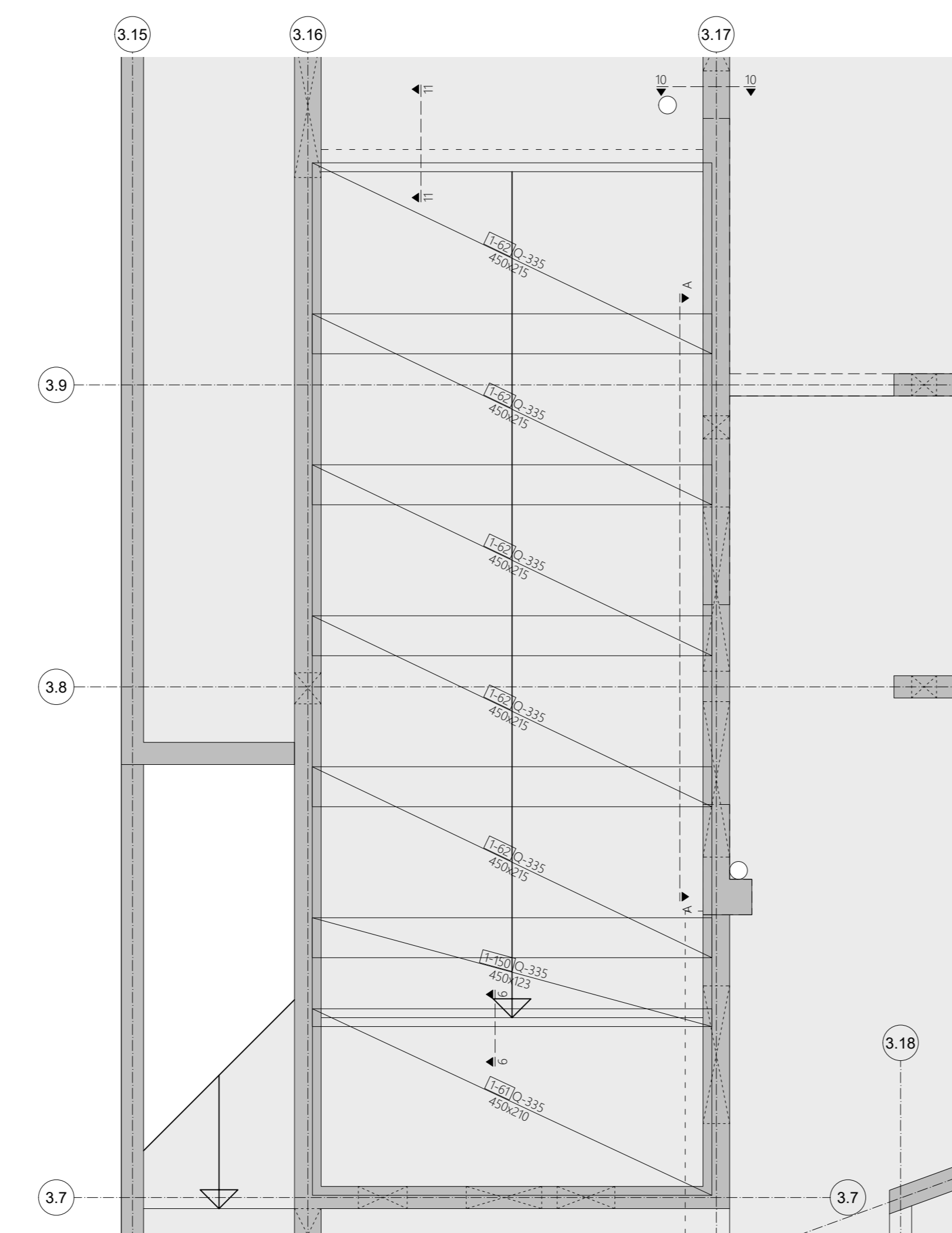
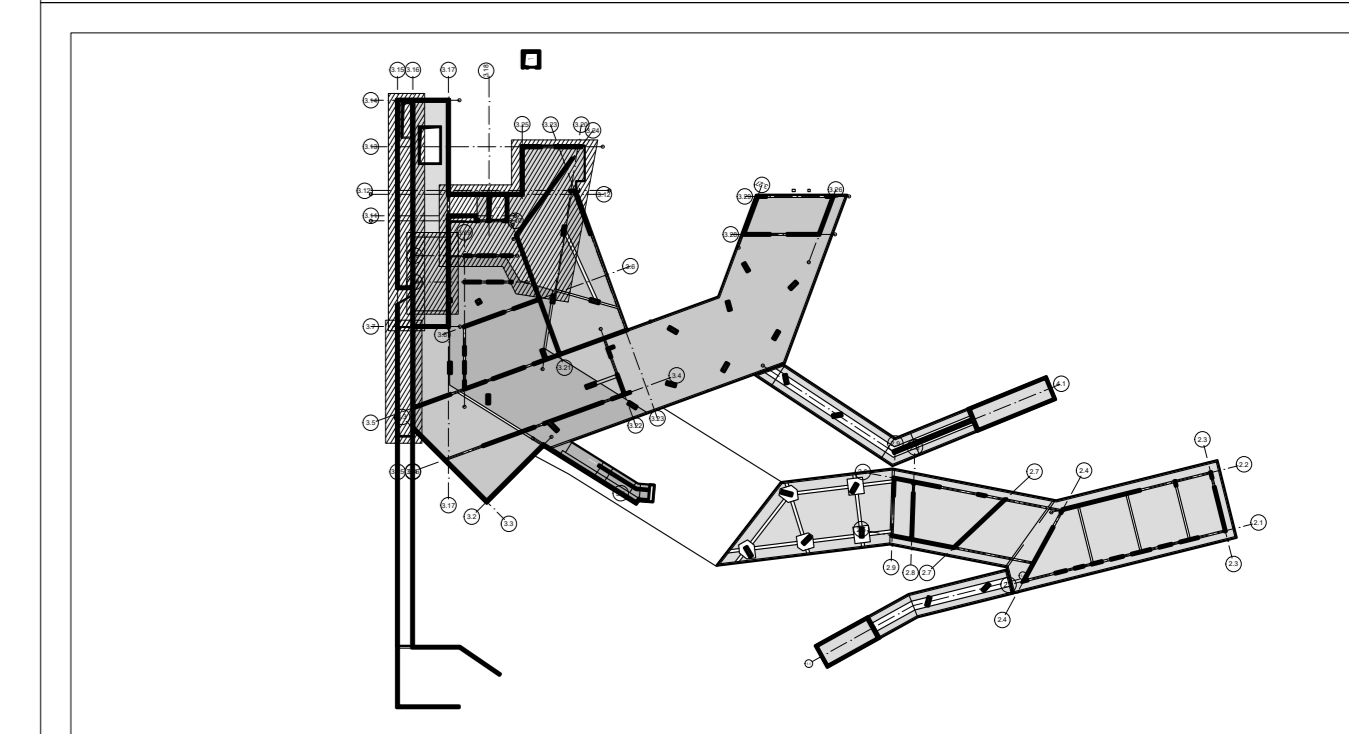

Table with columns for reinforcement details, including bar diameter, length, and quantity. It lists various reinforcement bars and their specifications for different parts of the slab.

NAPOMENA: Šipke prilagoditi i po potrebi rezati na licu mjesta. Preklap 500. NAPOMENA: Sve dimenzije provjeriti prema važećim planovima oplata.

Table with technical specifications for concrete and reinforcement, including class of concrete (C 30/37), reinforcement type (B 500 B), and details of the reinforcement cage.





Project information block including company name (KONSTRUKTA), project name (REKONSTRUKCIJA TERMINALNOG REKREACIJSKOG CENTRA U TUNELU), location, and contact details.

ISKAZ ARMATURE	
GRAĐEVINA:	REKONSTRUKCIJA TERMALNOG REKREACIJSKOG CENTRA TERME TUHELJ
ISKAZ UZ NACRT:	ARM_E-2_301-308
SADRŽAJ:	ARMATURA STROPNE PLOČE -2
DATUM:	srpanj, 2023.

Šipke - specifikacija						
ozn	oblik i mjere [cm]	Ø	lg [m]	n [kom]	lgn [m]	Napomena
STROPNA PLOČA E-2 (1 kom)						
1	400	20	4.00	352	1408.00	
2	1200	16	12.00	25	300.00	
3	1170	16	11.70	12	140.40	
4	1165	16	11.65	4	46.60	
5	1140	16	11.40	6	68.40	
6	1075	16	10.75	1	10.75	
7	1055	16	10.55	1	10.55	
8	1020	16	10.20	4	40.80	
9	1005	16	10.05	1	10.05	
10	965	16	9.65	3	28.95	
11	960	16	9.60	4	38.40	
12	915	16	9.55	4	38.20	
13	925	16	9.25	4	37.00	
14	900	16	9.00	2	18.00	
15	875	16	8.75	5	43.75	
16	855	16	8.55	3	25.65	
17	770	16	7.70	2	15.40	
18	740	16	7.40	4	29.60	
19	720	16	7.20	5	36.00	
20	700	16	7.00	9	63.00	
21	675	16	6.75	4	27.00	
22	600	16	6.00	11	66.00	
23	580	16	5.80	4	23.20	
24	485	16	4.85	4	19.40	
25	480	16	4.80	4	19.20	
26	395	16	4.65	3	13.95	
27	450	16	4.50	4	18.00	

ISKAZ ARMATURE

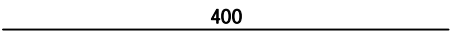
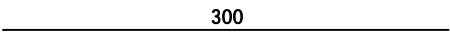
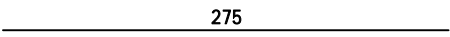
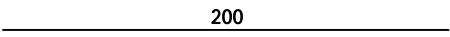
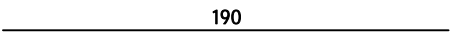
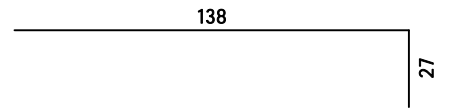
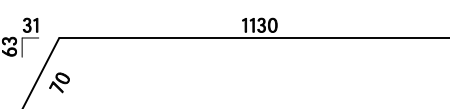
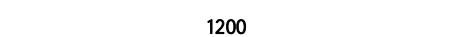
GRAĐEVINA:	REKONSTRUKCIJA TERMALNOG REKREACIJSKOG CENTRA TERME TUHELJ
ISKAZ UZ NACRT:	ARM_E-2_301-308
SADRŽAJ:	ARMATURA STROPNE PLOČE -2
DATUM:	srpanj, 2023.

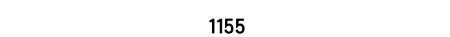
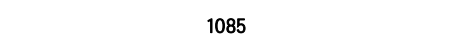
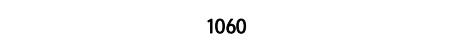
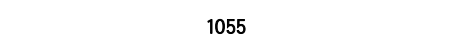
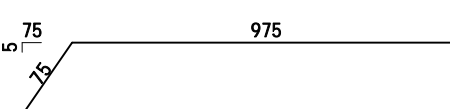
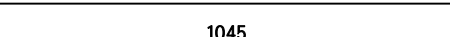
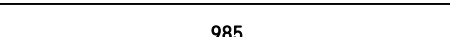
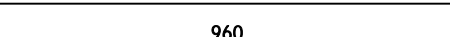
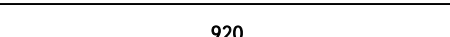
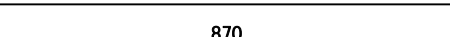
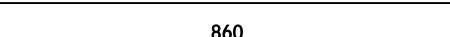
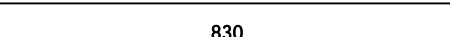
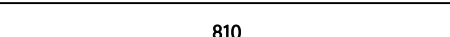
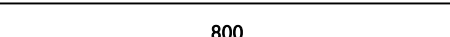
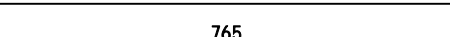
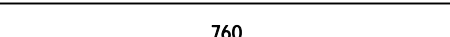
Šipke - specifikacija						
ozn	oblik i mjere [cm]	Ø	lg [m]	n [kom]	lgn [m]	Napomena
28		16	4.00	8	32.00	
29		16	3.00	4	12.00	
30		16	2.75	5	13.75	
31		16	2.00	2	4.00	
32		16	1.90	4	7.60	
33		16	1.65	2	3.30	
34		14	12.00	4	48.00	
35		14	12.00	97	1164.00	
36		14	11.85	4	47.40	
37		14	11.65	4	46.60	
38		14	11.55	2	23.10	
39		14	10.85	4	43.40	
40		14	10.60	6	63.60	
41		14	10.55	4	42.20	
42		14	10.50	8	84.00	
43		14	10.45	4	41.80	
44		14	9.85	4	39.40	
45		14	9.60	4	38.40	
46		14	9.20	4	36.80	
47		14	8.70	4	34.80	
48		14	8.60	8	68.80	
49		14	8.30	4	33.20	
50		14	8.10	4	32.40	
51		14	8.00	13	104.00	
52		14	7.65	4	30.60	
53		14	7.60	4	30.40	





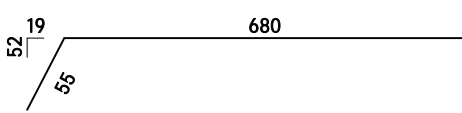
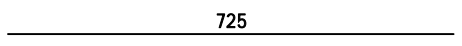
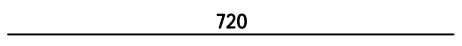
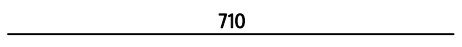
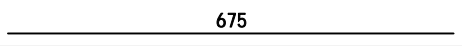
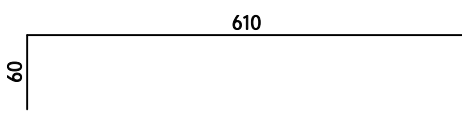
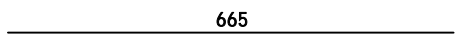
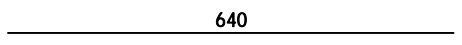
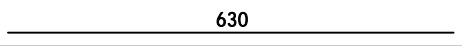
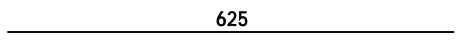
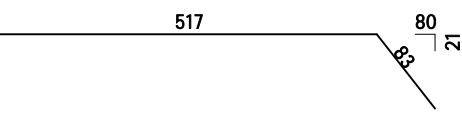
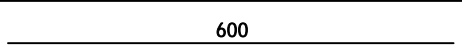
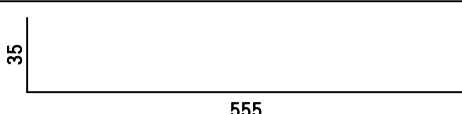
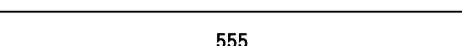
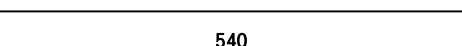
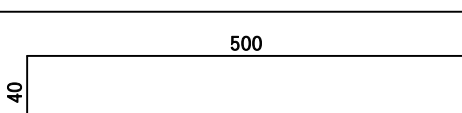
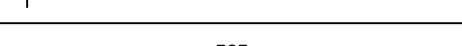
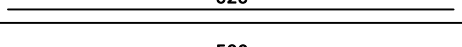
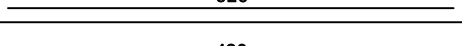
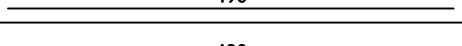
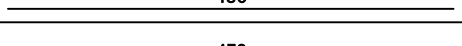
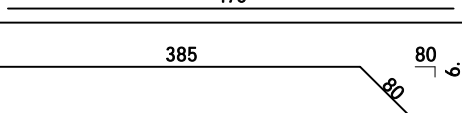





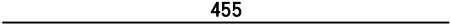

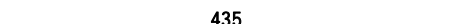
ISKAZ ARMATURE

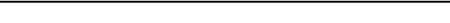
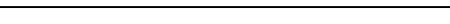
GRAĐEVINA:	REKONSTRUKCIJA TERMALNOG REKREACIJSKOG CENTRA TERME TUHELJ
ISKAZ UZ NACRT:	ARM_E-2_301-308
SADRŽAJ:	ARMATURA STROPNE PLOČE -2
DATUM:	srpanj, 2023.

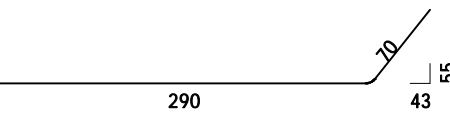
Šipke - specifikacija						
ozn	oblik i mjere [cm]	Ø	lg [m]	n [kom]	lgn [m]	Napomena
54		14	7.35	4	29.40	
55		14	7.25	12	87.00	
56		14	7.20	4	28.80	
57		14	7.10	4	28.40	
58		14	6.75	4	27.00	
59		14	6.70	2	13.40	
60		14	6.65	5	33.25	
61		14	6.40	12	76.80	
62		14	6.30	4	25.20	
63		14	6.25	8	50.00	
64		14	6.00	8	48.00	
65		14	6.00	4	24.00	
66		14	5.90	8	47.20	
67		14	5.55	4	22.20	
68		14	5.40	4	21.60	
69		14	5.40	4	21.60	
70		14	5.25	9	47.25	
71		14	5.20	14	72.80	
72		14	4.90	4	19.60	
73		14	4.80	12	57.60	
74		14	4.70	6	28.20	
75		14	4.65	4	18.60	

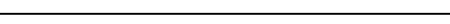
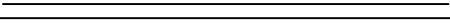
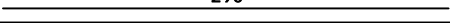
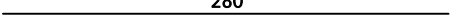
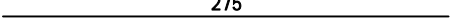

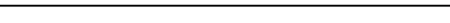
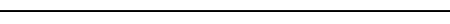
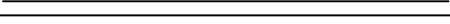
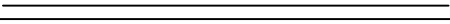
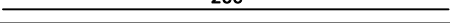
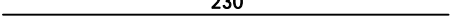
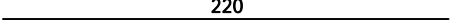
ISKAZ ARMATURE

GRAĐEVINA:	REKONSTRUKCIJA TERMALNOG REKREACIJSKOG CENTRA TERME TUHELJ
ISKAZ UZ NACRT:	ARM_E-2_301-308
SADRŽAJ:	ARMATURA STROPNE PLOČE -2
DATUM:	srpanj, 2023.

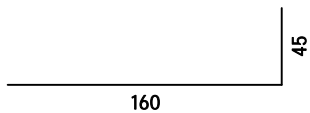

Šipke - specifikacija						
ozn	oblik i mjere [cm]	Ø	lg [m]	n [kom]	lgn [m]	Napomena
76		14	4.55	4	18.20	
77		14	4.40	16	70.40	
78		14	4.35	8	34.80	
79		14	4.25	4	17.00	
80		14	4.00	249	996.00	
81		14	3.85	2	7.70	
82		14	3.70	4	14.80	
83		14	3.60	2	7.20	
84		14	3.60	2	7.20	
85		14	3.45	4	13.80	
86		14	3.40	2	6.80	
87		14	2.95	4	11.80	
88		14	2.90	16	46.40	
89		14	2.80	8	22.40	
90		14	2.75	8	22.00	
91		14	2.70	4	10.80	
92		14	2.65	8	21.20	
93		14	2.65	2	5.30	
94		14	2.60	38	98.80	
95		14	2.50	8	20.00	
96		14	2.35	4	9.40	
97		14	2.30	4	9.20	
98		14	2.20	8	17.60	
99		14	2.15	4	8.60	
100		14	2.10	4	8.40	

ISKAZ ARMATURE

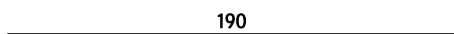
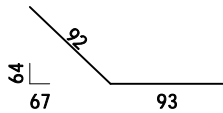
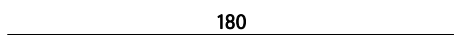
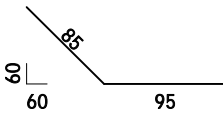
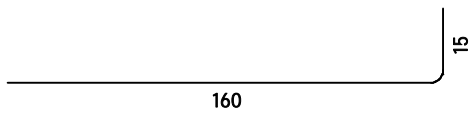
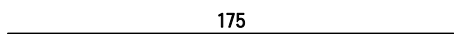
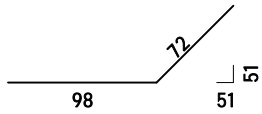
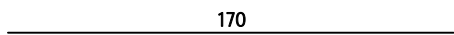
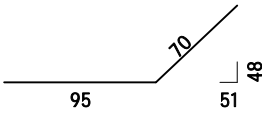
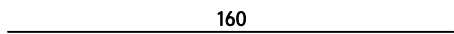
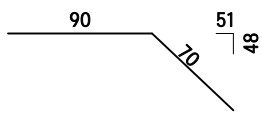
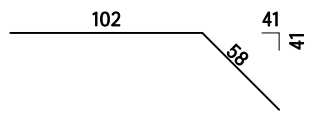
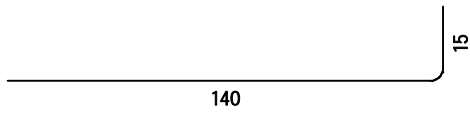
GRAĐEVINA:	REKONSTRUKCIJA TERMALNOG REKREACIJSKOG CENTRA TERME TUHELJ
ISKAZ UZ NACRT:	ARM_E-2_301-308
SADRŽAJ:	ARMATURA STROPNE PLOČE -2
DATUM:	srpanj, 2023.

Šipke - specifikacija						
ozn	oblik i mjere [cm]	Ø	lg [m]	n [kom]	lgn [m]	Napomena
101		14	2.05	2	4.10	
102		14	1.95	8	15.60	
103		14	1.90	16	30.40	
104		14	1.90	8	15.20	
105		14	1.85	2	3.70	
106		14	1.80	8	14.40	
107		14	1.80	2	3.60	
108		14	1.75	4	7.00	
109		14	1.75	4	7.00	
110		14	1.70	2	3.40	
111		14	1.70	44	74.80	
112		14	1.65	2	3.30	
113		14	1.60	4	6.40	
114		14	1.60	2	3.20	
115		14	1.60	2	3.20	
116		14	1.55	4	6.20	

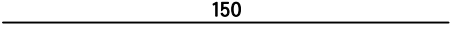
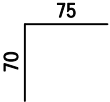
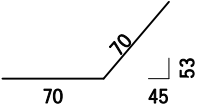
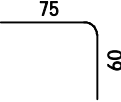
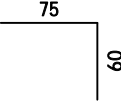
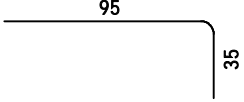
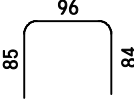
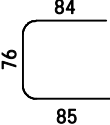
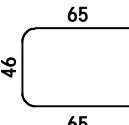
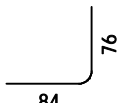
ISKAZ ARMATURE	
GRAĐEVINA:	REKONSTRUKCIJA TERMALNOG REKREACIJSKOG CENTRA TERME TUHELJ
ISKAZ UZ NACRT:	ARM_E-2_301-308
SADRŽAJ:	ARMATURA STROPNE PLOČE -2
DATUM:	srpanj, 2023.

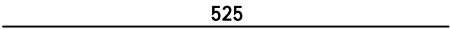
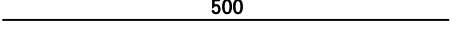
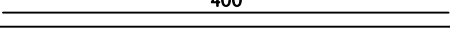
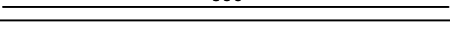

Šipke - specifikacija						
ozn	oblik i mjere [cm]	Ø	lg [m]	n [kom]	lgn [m]	Napomena
117		14	1.50	8	12.00	
118		14	1.45	4	5.80	
119		14	1.40	12	16.80	
120		14	1.35	8	10.80	
121		14	1.35	4	5.40	
122		14	1.30	6	7.80	
123		12	2.65	10	26.50	
124		12	2.45	4	9.80	
125		12	1.76	8	14.08	
126		12	1.60	4	6.40	
127		10	6.00	56	336.00	
128		10	5.25	50	262.50	
129		10	5.00	127	635.00	
130		10	4.00	184	736.00	
131		10	3.50	8	28.00	

ISKAZ ARMATURE

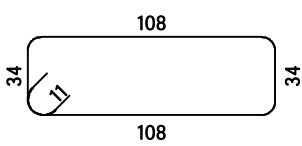
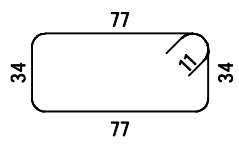
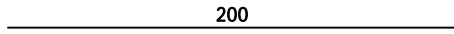
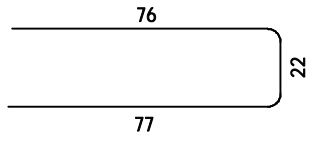
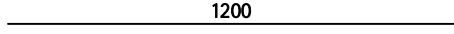
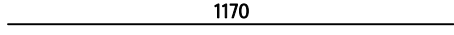
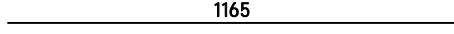
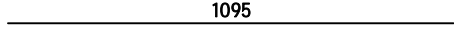
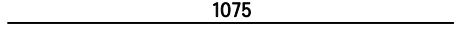
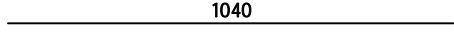
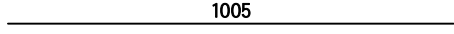
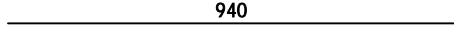
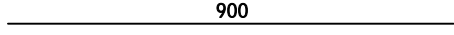
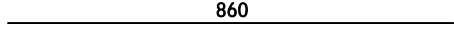
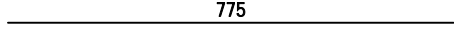
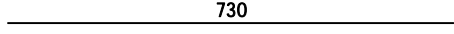
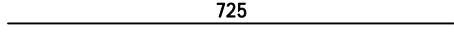
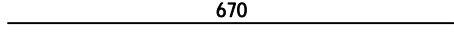
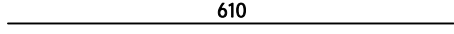
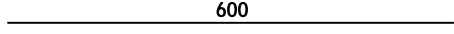
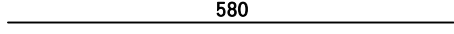
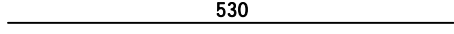
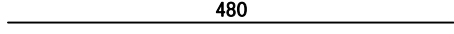
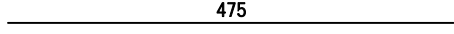
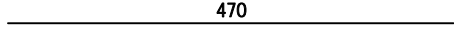
GRAĐEVINA:	REKONSTRUKCIJA TERMALNOG REKREACIJSKOG CENTRA TERME TUHELJ
ISKAZ UZ NACRT:	ARM_E-2_301-308
SADRŽAJ:	ARMATURA STROPNE PLOČE -2
DATUM:	srpanj, 2023.

Šipke - specifikacija						
ozn	oblik i mjere [cm]	Ø	lg [m]	n [kom]	lgn [m]	Napomena
132		10	3.06	6	18.36	
133		10	2.44	14	34.16	
134		10	2.00	4	8.00	
135		10	1.75	4	7.00	
136		8	12.00	34	408.00	
137		8	11.70	8	93.60	
138		8	11.65	2	23.30	
139		8	10.95	4	43.80	
140		8	10.75	1	10.75	
141		8	10.40	2	20.80	
142		8	10.05	1	10.05	
143		8	9.40	2	18.80	
144		8	9.00	28	252.00	
145		8	8.60	10	86.00	
146		8	7.75	12	93.00	
147		8	7.30	2	14.60	
148		8	7.25	6	43.50	
149		8	6.70	4	26.80	
150		8	6.10	6	36.60	
151		8	6.00	104	624.00	
152		8	5.80	14	81.20	
153		8	5.30	4	21.20	
154		8	4.80	16	76.80	
155		8	4.75	10	47.50	
156		8	4.70	12	56.40	

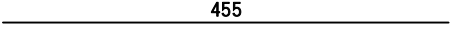
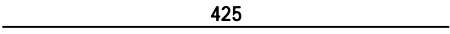
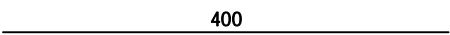
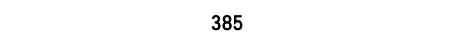
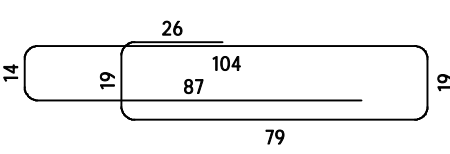
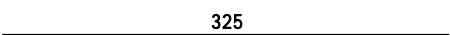
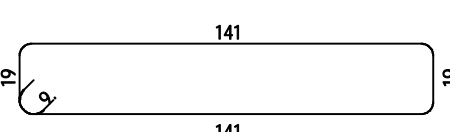
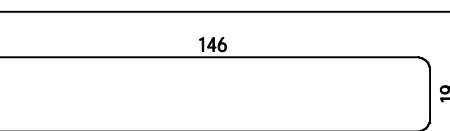
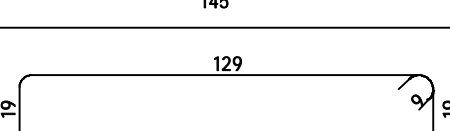
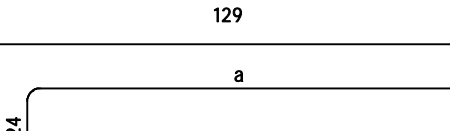
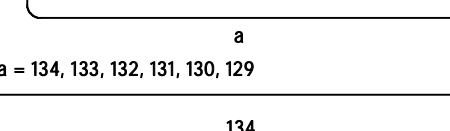
ISKAZ ARMATURE	
GRAĐEVINA:	REKONSTRUKCIJA TERMALNOG REKREACIJSKOG CENTRA TERME TUHELJ
ISKAZ UZ NACRT:	ARM_E-2_301-308
SADRŽAJ:	ARMATURA STROPNE PLOČE -2
DATUM:	srpanj, 2023.

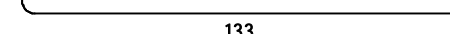
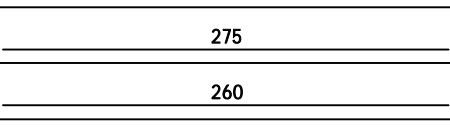
Šipke - specifikacija						
ozn	oblik i mjere [cm]	Ø	lg [m]	n [kom]	lgn [m]	Napomena
157		8	4.55	8	36.40	
158		8	4.25	10	42.50	
159		8	4.00	48	192.00	
160		8	3.85	30	115.50	
161		8	3.48	96	334.08	
162		8	3.25	4	13.00	
163		8	3.38	67	226.46	
164		8	3.10	30	93.00	
165		8	3.14	30	94.20	
166	 a = 134, 133, 132, 131, 130, 129	8	*2.87	1 x 6	17.22	
167		8	2.85	19	54.15	
168		8	2.75	6	16.50	
169		8	2.60	2	5.20	
170		8	2.74	209	572.66	

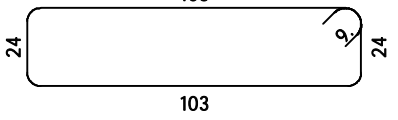
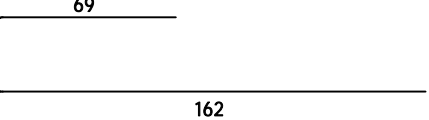
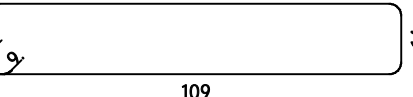
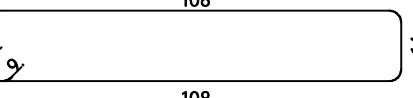
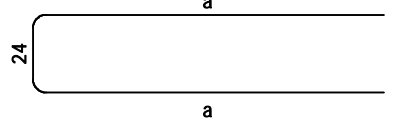
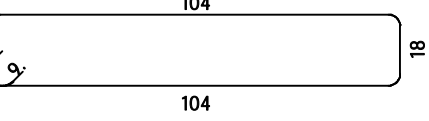
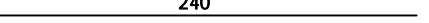
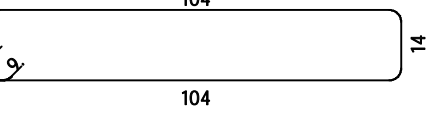
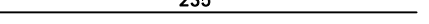
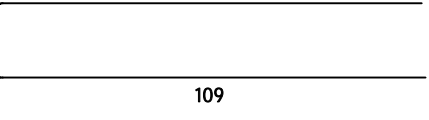
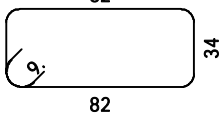

ISKAZ ARMATURE

GRAĐEVINA:	REKONSTRUKCIJA TERMALNOG REKREACIJSKOG CENTRA TERME TUHELJ
ISKAZ UZ NACRT:	ARM_E-2_301-308
SADRŽAJ:	ARMATURA STROPNE PLOČE -2
DATUM:	srpanj, 2023.

Šipke - specifikacija						
ozn	oblik i mjere [cm]	Ø	lg [m]	n [kom]	lgn [m]	Napomena
171		8	2.72	81	220.32	
172		8	2.50	6	15.00	
173		8	2.64	28	73.92	
174		8	2.62	102	267.24	
175	 a = 107, 108, 110	8	*2.41	1 x 3	7.22	
176		8	2.62	32	83.84	
177		8	2.40	2	4.80	
178		8	2.54	304	772.16	
179		8	2.35	14	32.90	
180		8	2.35	104	244.40	
181		8	2.50	66	165.00	

ISKAZ ARMATURE

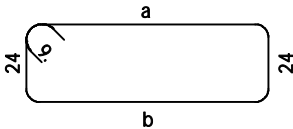
GRAĐEVINA:	REKONSTRUKCIJA TERMALNOG REKREACIJSKOG CENTRA TERME TUHELJ
ISKAZ UZ NACRT:	ARM_E-2_301-308
SADRŽAJ:	ARMATURA STROPNE PLOČE -2
DATUM:	srpanj, 2023.

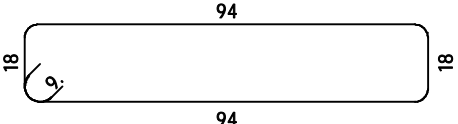
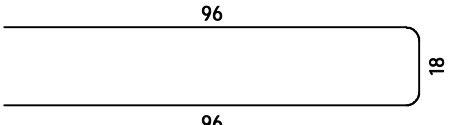
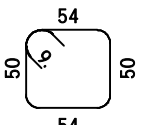
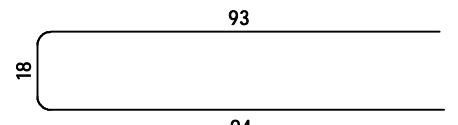
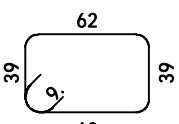
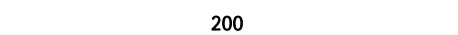
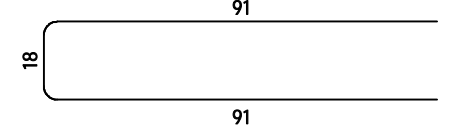
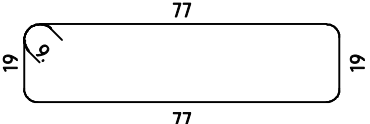
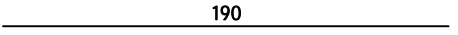
Šipke - specifikacija						
ozn	oblik i mjere [cm]	Ø	lg [m]	n [kom]	lgn [m]	Napomena
182	 <p>a = 67, 68, 69, 70, 71, 73, 74, 75, 76, 77, 78, 79, 80, 81, 82 b = 67, 68, 69, 70, 71, 73, 74, 75, 76, 77, 78, 79, 80, 81, 82</p>	8	*2.15	1 x 15	32.30	
183		8	2.25	34	76.50	
184		8	2.42	12	29.04	
185		8	2.10	152	319.20	
186		8	2.26	50	113.00	
187		8	2.05	166	340.30	
188		8	2.20	47	103.40	
189		8	2.00	6	12.00	
190		8	2.00	203	406.00	
191		8	2.10	53	111.30	
192		8	1.90	8	15.20	

ISKAZ ARMATURE

GRAĐEVINA:	REKONSTRUKCIJA TERMALNOG REKREACIJSKOG CENTRA TERME TUHELJ
ISKAZ UZ NACRT:	ARM_E-2_301-308
SADRŽAJ:	ARMATURA STROPNE PLOČE -2
DATUM:	srpanj, 2023.

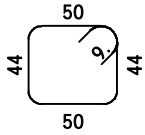
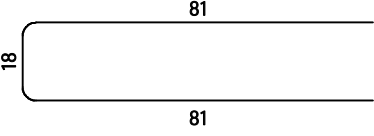
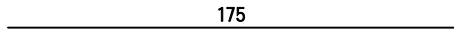
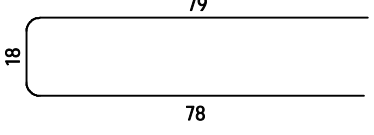
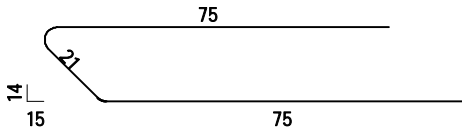
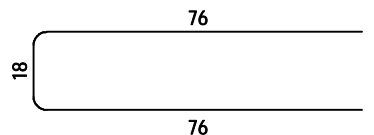
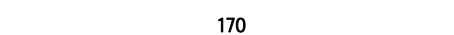
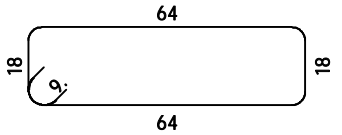
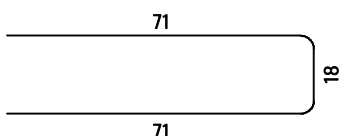
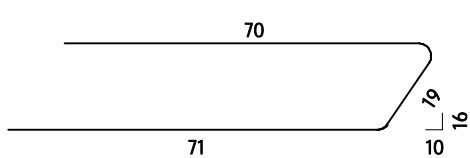
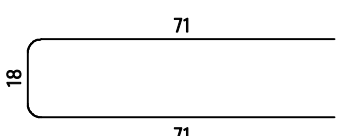

Šipke - specifikacija						
ozn	oblik i mjere [cm]	Ø	lg [m]	n [kom]	lgn [m]	Napomena
193		8	2.06	72	148.32	
194		8	1.80	37	66.60	
195		8	1.75	12	21.00	
196		8	1.75	227	397.25	
197		8	1.71	10	17.10	
198		8	1.70	69	117.30	
199		8	1.70	160	272.00	
200		8	1.82	31	56.42	
201		8	1.60	316	505.60	
202		8	1.60	6	9.60	
203		8	1.60	1375	2200.00	

ISKAZ ARMATURE

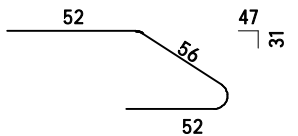
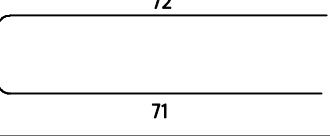
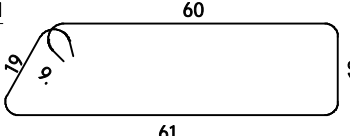
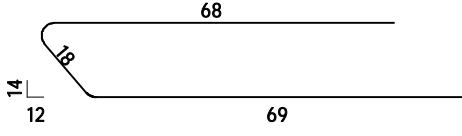
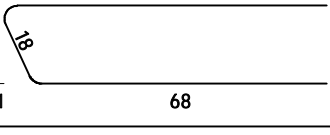
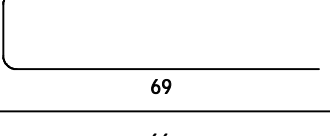
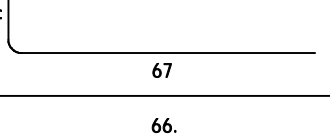
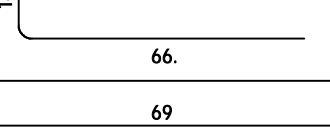
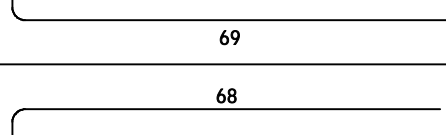
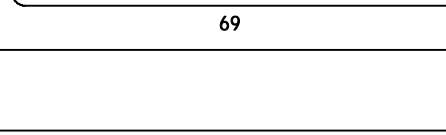
GRAĐEVINA:	REKONSTRUKCIJA TERMALNOG REKREACIJSKOG CENTRA TERME TUHELJ
ISKAZ UZ NACRT:	ARM_E-2_301-308
SADRŽAJ:	ARMATURA STROPNE PLOČE -2
DATUM:	srpanj, 2023.



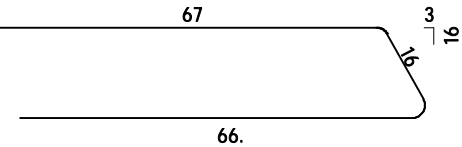
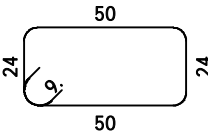
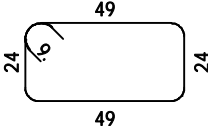
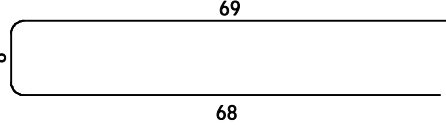

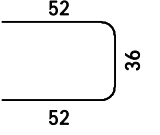
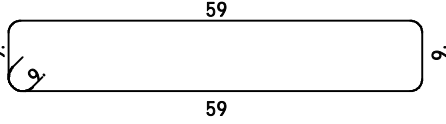
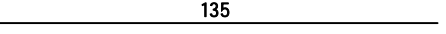
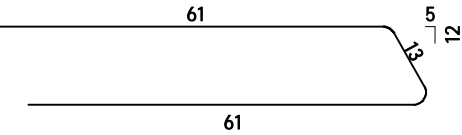
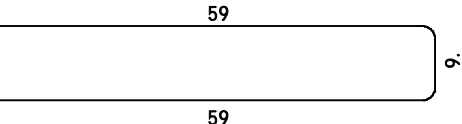
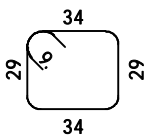

Šipke - specifikacija						
ozn	oblik i mjere [cm]	Ø	lg [m]	n [kom]	lgn [m]	Napomena
204		8	1.60	10	16.00	
205		8	1.60	132	211.20	
206		8	1.77	29	51.33	
207		8	1.55	14	21.70	
208		8	1.55	33	51.15	
209		8	1.54	5	7.70	
210		8	1.50	12	18.00	
211		8	1.50	343	514.50	
212		8	1.50	2	3.00	
213		8	1.49	7	10.43	

ISKAZ ARMATURE	
GRAĐEVINA:	REKONSTRUKCIJA TERMALNOG REKREACIJSKOG CENTRA TERME TUHELJ
ISKAZ UZ NACRT:	ARM_E-2_301-308
SADRŽAJ:	ARMATURA STROPNE PLOČE -2
DATUM:	srpanj, 2023.

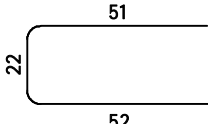
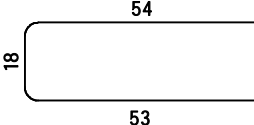
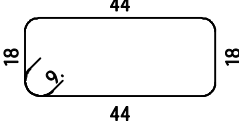
Šipke - specifikacija						
ozn	oblik i mjere [cm]	Ø	lg [m]	n [kom]	lgn [m]	Napomena
214		8	1.49	14	20.86	
215		8	1.66	4	6.64	
216		8	1.64	105	172.20	
217		8	1.45	100	145.00	
218		8	1.40	345	483.00	
219		8	1.40	3	4.20	
220		8	1.54	78	120.12	
221		8	1.35	48	64.80	
222		8	1.35	19	25.65	
223		8	1.27	24	30.48	
224		8	1.44	3	4.32	

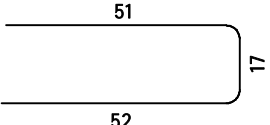
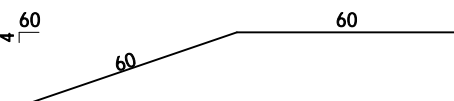
ISKAZ ARMATURE

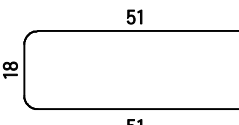
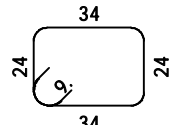
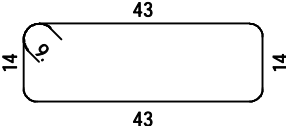
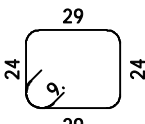
GRAĐEVINA:	REKONSTRUKCIJA TERMALNOG REKREACIJSKOG CENTRA TERME TUHELJ
ISKAZ UZ NACRT:	ARM_E-2_301-308
SADRŽAJ:	ARMATURA STROPNE PLOČE -2
DATUM:	srpanj, 2023.

Šipke - specifikacija						
ozn	oblik i mjere [cm]	Ø	lg [m]	n [kom]	lgn [m]	Napomena
225		8	1.25	14	17.50	
226		8	1.25	44	55.00	
227		8	1.42	3	4.26	
228		8	1.20	974	1168.80	
229		8	1.20	14	16.80	
230		8	1.20	58	69.60	
231		8	1.20	48	57.60	
232		8	1.20	44	52.80	
233		8	1.34	4	5.36	
234		8	1.32	68	89.76	
235		8	1.24	6	7.44	
236		8	1.05	96	100.80	

ISKAZ ARMATURE

GRAĐEVINA:	REKONSTRUKCIJA TERMALNOG REKREACIJSKOG CENTRA TERME TUHELJ
ISKAZ UZ NACRT:	ARM_E-2_301-308
SADRŽAJ:	ARMATURA STROPNE PLOČE -2
DATUM:	srpanj, 2023.

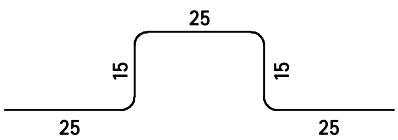
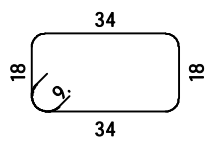
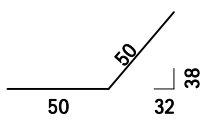
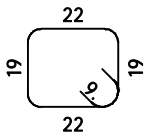
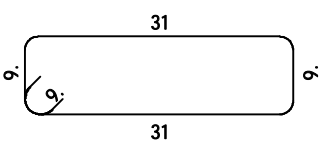
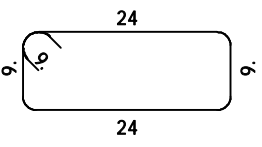
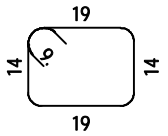
Šipke - specifikacija						
ozn	oblik i mjere [cm]	Ø	lg [m]	n [kom]	lgn [m]	Napomena
237		8	1.05	2692	2826.60	
238		8	1.22	8	9.76	
239		8	1.00	15	15.00	
240		8	1.00	2	2.00	
241		8	0.98	22	21.56	
242		8	0.84	6	5.04	
243		8	0.84	3	2.52	

ISKAZ ARMATURE	
GRAĐEVINA:	REKONSTRUKCIJA TERMALNOG REKREACIJSKOG CENTRA TERME TUHELJ
ISKAZ UZ NACRT:	ARM_E-2_301-308
SADRŽAJ:	ARMATURA STROPNE PLOČE -2
DATUM:	srpanj, 2023.

Šipke - rekapitulacija			
Ø [mm]	lgn [m]	Jedinična težina [kg/m ¹]	Težina [kg]
B500B			
8	17668.28	0.40	6978.97
10	2065.02	0.62	1274.12
12	56.78	0.89	50.42
14	4646.70	1.21	5622.51
16	1260.90	1.58	1992.22
20	1408.00	2.47	3477.76
Ukupno (B500B)			19396.00
Ukupno			19396.00

ISKAZ ARMATURE	
GRAĐEVINA:	REKONSTRUKCIJA TERMALNOG REKREACIJSKOG CENTRA TERME TUHELJ
ISKAZ UZ NACRT:	ARM_E-2_301-308
SADRŽAJ:	ARMATURA STROPNE PLOČE -2
DATUM:	srpanj, 2023.

Mreže - specifikacija							
Pozicija	Oznaka mreže	B [cm]	L [cm]	n	Jedinična težina [kg/m ²]	Ukupna težina [kg]	Napomena
STROPNA PLOČA E-2 (1 kom)							
1	Q-335	215	600	49	5.38	3400.70	
1-1	Q-335	190	521	2	5.38	106.50	
1-2	Q-335	190	600	4	5.38	245.33	
1-3	Q-335	190	600	2	5.38	122.66	
1-4	Q-335	190	600	2	5.38	122.66	
1-5	Q-335	190	600	2	5.38	122.66	
1-6	Q-335	190	200	2	5.38	40.89	
1-7	Q-335	198	215	1	5.38	22.95	
1-8	Q-335	215	465	1	5.38	53.63	
1-9	Q-335	89	165	1	5.38	7.93	
1-10	Q-335	215	421	2	5.38	97.51	
1-11	Q-335	215	335	2	5.38	77.50	
1-12	Q-335	215	395	1	5.38	45.69	
1-13	Q-335	122	207	1	5.38	13.60	
1-14	Q-335	215	312	1	5.38	36.09	
1-15	Q-335	215	374	1	5.38	43.22	
1-16	Q-335	215	435	1	5.38	50.36	
1-17	Q-335	215	497	1	5.38	57.49	
1-18	Q-335	215	559	1	5.38	64.63	
1-19	Q-335	215	600	74	5.38	5135.75	
1-20	Q-335	209	600	1	5.38	67.35	
1-21	Q-335	215	250	1	5.38	28.94	
1-22	Q-335	215	291	3	5.38	101.01	
1-23	Q-335	164	248	1	5.38	21.91	
1-24	Q-335	215	591	1	5.38	68.33	
1-25	Q-335	183	200	1	5.38	19.69	
1-26	Q-335	215	200	1	5.38	23.14	
1-27	Q-335	215	200	1	5.38	23.14	
1-28	Q-335	215	200	1	5.38	23.14	
1-29	Q-335	215	200	1	5.38	23.14	
1-30	Q-335	215	200	1	5.38	23.14	
1-31	Q-335	78	100	1	5.38	4.22	
1-32	Q-335	112	539	1	5.38	32.59	
1-33	Q-335	215	275	1	5.38	31.83	
1-34	Q-335	215	493	1	5.38	57.00	
1-35	Q-335	121	155	1	5.38	10.15	
1-36	Q-335	215	210	1	5.38	24.29	

ISKAZ ARMATURE	
GRAĐEVINA:	REKONSTRUKCIJA TERMALNOG REKREACIJSKOG CENTRA TERME TUHELJ
ISKAZ UZ NACRT:	ARM_E-2_301-308
SADRŽAJ:	ARMATURA STROPNE PLOČE -2
DATUM:	srpanj, 2023.

Mreže - specifikacija							
Pozicija	Oznaka mreže	B [cm]	L [cm]	n	Jedinična težina [kg/m2]	Ukupna težina [kg]	Napomena
1-37	Q-335	215	210	1	5.38	24.29	
1-38	Q-335	215	210	1	5.38	24.29	
1-39	Q-335	215	210	1	5.38	24.29	
1-40	Q-335	215	210	1	5.38	24.29	
1-41	Q-335	215	207	1	5.38	23.97	
1-42	Q-335	215	545	1	5.38	63.00	
1-43	Q-335	215	327	1	5.38	37.83	
1-44	Q-335	86	109	1	5.38	5.04	
1-45	Q-335	215	275	1	5.38	31.83	
1-46	Q-335	215	320	2	5.38	74.03	
1-47	Q-335	215	320	2	5.38	74.03	
1-48	Q-335	215	320	2	5.38	74.03	
1-49	Q-335	215	320	1	5.38	37.01	
1-50	Q-335	215	317	1	5.38	36.70	
1-51	Q-335	78	100	1	5.38	4.17	
1-52	Q-335	215	227	1	5.38	26.31	
1-53	Q-335	215	241	1	5.38	27.91	
1-54	Q-335	215	255	1	5.38	29.51	
1-55	Q-335	215	269	1	5.38	31.11	
1-56	Q-335	215	283	1	5.38	32.72	
1-57	Q-335	215	297	1	5.38	34.32	
1-58	Q-335	215	286	1	5.38	33.13	
1-59	Q-335	215	283	1	5.38	32.72	
1-60	Q-335	189	235	1	5.38	23.84	
1-61	Q-335	210	450	4	5.38	203.27	
1-62	Q-335	215	450	24	5.38	1249.24	
1-63	Q-335	215	569	1	5.38	65.81	
1-64	Q-335	195	537	1	5.38	56.39	
1-65	Q-335	115	450	1	5.38	27.84	
1-66	Q-335	215	450	2	5.38	104.10	
1-67	Q-335	215	450	4	5.38	208.21	
1-68	Q-335	132	450	1	5.38	32.08	
1-69	Q-335	190	600	2	5.38	122.66	
1-70	Q-335	190	600	2	5.38	122.66	
1-71	Q-335	190	275	2	5.38	56.22	
1-72	Q-335	215	461	1	5.38	53.34	
1-73	Q-335	126	130	1	5.38	8.82	
1-74	Q-335	215	120	1	5.38	13.90	

ISKAZ ARMATURE	
GRAĐEVINA:	REKONSTRUKCIJA TERMALNOG REKREACIJSKOG CENTRA TERME TUHELJ
ISKAZ UZ NACRT:	ARM_E-2_301-308
SADRŽAJ:	ARMATURA STROPNE PLOČE -2
DATUM:	srpanj, 2023.

Mreže - specifikacija							
Pozicija	Oznaka mreže	B [cm]	L [cm]	n	Jedinična težina [kg/m ²]	Ukupna težina [kg]	Napomena
1-75	Q-335	215	596	1	5.38	68.93	
1-76	Q-335	215	517	1	5.38	59.76	
1-77	Q-335	215	437	1	5.38	50.59	
1-78	Q-335	214	358	1	5.38	41.28	
1-79	Q-335	215	302	1	5.38	34.98	
1-80	Q-335	215	444	1	5.38	51.31	
1-81	Q-335	215	529	1	5.38	61.18	
1-82	Q-335	215	582	1	5.38	67.37	
1-83	Q-335	85	600	1	5.38	27.44	
1-84	Q-335	85	534	1	5.38	24.44	
1-85	Q-335	150	594	1	5.38	47.96	
1-86	Q-335	201	465	1	5.38	50.37	
1-87	Q-335	128	277	1	5.38	19.15	
1-88	Q-335	215	530	12	5.38	735.66	
1-89	Q-335	70	189	1	5.38	7.14	
1-90	Q-335	154	286	1	5.38	23.71	
1-91	Q-335	215	485	6	5.38	336.60	
1-92	Q-335	131	352	1	5.38	24.74	
1-93	Q-335	215	500	2	5.38	115.67	
1-94	Q-335	215	368	1	5.38	42.57	
1-95	Q-335	118	150	2	5.38	19.02	
1-96	Q-335	215	245	1	5.38	28.34	
1-97	Q-335	215	533	2	5.38	123.24	
1-98	Q-335	94	128	1	5.38	6.46	
1-99	Q-335	94	600	1	5.38	30.37	
1-100	Q-335	94	291	1	5.38	14.72	
1-101	Q-335	215	533	8	5.38	492.94	
1-102	Q-335	215	288	10	5.38	332.55	
1-103	Q-335	215	291	8	5.38	269.05	
1-104	Q-335	166	358	2	5.38	63.94	
1-105	Q-335	110	238	1	5.38	14.13	
1-106	Q-335	137	291	1	5.38	21.42	
1-107	Q-335	215	311	1	5.38	35.96	
1-108	Q-335	215	411	1	5.38	47.55	
1-109	Q-335	215	374	1	5.38	43.27	
1-110	Q-335	215	267	1	5.38	30.87	
1-111	Q-335	215	160	1	5.38	18.47	
1-112	Q-335	116	450	1	5.38	28.08	

ISKAZ ARMATURE	
GRAĐEVINA:	REKONSTRUKCIJA TERMALNOG REKREACIJSKOG CENTRA TERME TUHELJ
ISKAZ UZ NACRT:	ARM_E-2_301-308
SADRŽAJ:	ARMATURA STROPNE PLOČE -2
DATUM:	srpanj, 2023.

Mreže - specifikacija							
Pozicija	Oznaka mreže	B [cm]	L [cm]	n	Jedinična težina [kg/m ²]	Ukupna težina [kg]	Napomena
1-113	Q-335	118	337	1	5.38	21.37	
1-114	Q-335	149	331	1	5.38	26.51	
1-115	Q-335	215	413	1	5.38	47.75	
1-116	Q-335	215	413	1	5.38	47.74	
1-117	Q-335	215	143	1	5.38	16.54	
1-118	Q-335	126	297	1	5.38	20.14	
1-119	Q-335	145	395	1	5.38	30.81	
1-120	Q-335	215	240	3	5.38	83.15	
1-121	Q-335	215	331	1	5.38	38.29	
1-122	Q-335	215	246	1	5.38	28.43	
1-123	Q-335	215	219	1	5.38	25.32	
1-124	Q-335	215	179	1	5.38	20.70	
1-125	Q-335	215	211	1	5.38	24.46	
1-126	Q-335	215	175	1	5.38	20.19	
1-127	Q-335	141	474	1	5.38	35.91	
1-128	Q-335	215	445	7	5.38	360.31	
1-129	Q-335	215	430	1	5.38	49.74	
1-130	Q-335	114	430	1	5.38	26.33	
1-131	Q-335	190	600	4	5.38	245.30	
1-132	Q-335	190	297	2	5.38	60.78	
1-133	Q-335	215	240	1	5.38	27.76	
1-134	Q-335	215	324	1	5.38	37.53	
1-135	Q-335	215	448	1	5.38	51.86	
1-136	Q-335	215	464	1	5.38	53.73	
1-137	Q-335	215	503	1	5.38	58.19	
1-138	Q-335	215	600	1	5.38	69.40	
1-139	Q-335	215	502	1	5.38	58.05	
1-140	Q-335	215	576	1	5.38	66.62	
1-141	Q-335	215	451	1	5.38	52.17	
1-142	Q-335	215	326	1	5.38	37.73	
1-143	Q-335	135	173	1	5.38	12.56	
1-144	Q-335	215	581	1	5.38	67.24	
1-145	Q-335	215	493	1	5.38	56.97	
1-146	Q-335	215	404	1	5.38	46.70	
1-147	Q-335	141	315	1	5.38	23.84	
1-148	Q-335	215	430	1	5.38	49.74	
1-149	Q-335	176	150	1	5.38	14.19	
1-150	Q-335	123	464	2	5.38	61.14	

ISKAZ ARMATURE	
GRAĐEVINA:	REKONSTRUKCIJA TERMALNOG REKREACIJSKOG CENTRA TERME TUHELJ
ISKAZ UZ NACRT:	ARM_E-2_301-308
SADRŽAJ:	ARMATURA STROPNE PLOČE -2
DATUM:	srpanj, 2023.

Mreže - specifikacija							
Pozicija	Oznaka mreže	B [cm]	L [cm]	n	Jedinična težina [kg/m ²]	Ukupna težina [kg]	Napomena
1-151	Q-335	215	483	1	5.38	55.87	
1-152	Q-335	215	458	1	5.38	52.95	
1-153	Q-335	215	364	1	5.38	42.13	
1-154	Q-335	215	271	1	5.38	31.33	
1-155	Q-335	215	178	1	5.38	20.54	
1-156	Q-335	215	84	1	5.38	9.74	
1-157	Q-335	215	546	1	5.38	63.13	
1-158	Q-335	215	452	1	5.38	52.28	
1-159	Q-335	215	338	1	5.38	39.06	
1-160	Q-335	215	248	1	5.38	28.73	
1-161	Q-335	212	162	1	5.38	18.51	
1-162	Q-335	215	367	1	5.38	42.46	
1-163	Q-335	215	600	2	5.38	138.80	
1-164	Q-335	215	591	1	5.38	68.39	
1-165	Q-335	215	517	1	5.38	59.75	
1-166	Q-335	215	372	1	5.38	43.04	
1-167	Q-335	215	210	1	5.38	24.25	
1-168	Q-335	207	420	1	5.38	46.87	
1-169	Q-335	193	247	1	5.38	25.66	
1-170	Q-335	144	373	1	5.38	28.95	
1-171	Q-335	144	600	1	5.38	46.51	
1-172	Q-335	215	585	1	5.38	67.66	
1-173	Q-335	215	368	1	5.38	42.54	
1-174	Q-335	215	536	1	5.38	62.03	
1-175	Q-335	163	439	1	5.38	38.54	
1-176	Q-335	215	510	3	5.38	176.98	
1-177	Q-335	215	470	1	5.38	54.32	
1-178	Q-335	215	430	1	5.38	49.78	
1-179	Q-335	215	391	1	5.38	45.24	
1-180	Q-335	215	352	1	5.38	40.71	
1-181	Q-335	215	313	1	5.38	36.17	
1-182	Q-335	215	273	1	5.38	31.63	
1-183	Q-335	215	234	1	5.38	27.09	
1-184	Q-335	215	195	1	5.38	22.55	
1-185	Q-335	154	484	1	5.38	40.17	
1-186	Q-335	57	79	1	5.38	2.41	
1-187	Q-335	89	245	1	5.38	11.75	
1-188	Q-335	215	600	1	5.38	69.40	

ISKAZ ARMATURE	
GRAĐEVINA:	REKONSTRUKCIJA TERMALNOG REKREACIJSKOG CENTRA TERME TUHELJ
ISKAZ UZ NACRT:	ARM_E-2_301-308
SADRŽAJ:	ARMATURA STROPNE PLOČE -2
DATUM:	srpanj, 2023.

Mreže - specifikacija							
Pozicija	Oznaka mreže	B [cm]	L [cm]	n	Jedinična težina [kg/m ²]	Ukupna težina [kg]	Napomena
1-189	Q-335	215	143	1	5.38	16.51	
1-190	Q-335	215	249	1	5.38	28.79	
1-191	Q-335	215	355	1	5.38	41.08	
1-192	Q-335	215	461	1	5.38	53.37	
1-193	Q-335	215	568	1	5.38	65.66	
1-194	Q-335	215	485	1	5.38	56.14	
1-195	Q-335	215	437	1	5.38	50.57	
1-196	Q-335	182	429	1	5.38	42.12	
1-197	Q-335	215	92	1	5.38	10.61	
1-198	Q-335	215	479	1	5.38	55.36	
1-199	Q-335	215	310	1	5.38	35.92	
1-200	Q-335	215	142	1	5.38	16.47	
1-201	Q-335	215	529	1	5.38	61.22	
1-202	Q-335	215	361	1	5.38	41.78	
1-203	Q-335	195	193	1	5.38	20.28	
1-204	Q-335	215	265	1	5.38	30.61	
1-205	Q-335	131	450	1	5.38	31.83	
Ukupno						21608.35	

ISKAZ ARMATURE	
GRAĐEVINA:	REKONSTRUKCIJA TERMALNOG REKREACIJSKOG CENTRA TERME TUHELJ
ISKAZ UZ NACRT:	ARM_E-2_301-308
SADRŽAJ:	ARMATURA STROPNE PLOČE -2
DATUM:	srpanj, 2023.

Mreže - rekapitulacija						
Oznaka mreže	B [cm]	L [cm]	n	Jedinična težina [kg/m ²]	Ukupna težina [kg]	Neto ugrađena težina [kg]
Q-335	215	600	344	5.38	23874.29	19705.79
Ukupno					23874.29	19705.79

ISKAZ ARMATURE	
GRAĐEVINA:	REKONSTRUKCIJA TERMALNOG REKREACIJSKOG CENTRA TERME TUHELJ
ISKAZ UZ NACRT:	ARM_E-2_301-308
SADRŽAJ:	ARMATURA STROPNE PLOČE -2
DATUM:	srpanj, 2023.

Mreže - plan rezanja
STROPNA PLOČA E-2
Q-335 (600 cm x 215 cm)

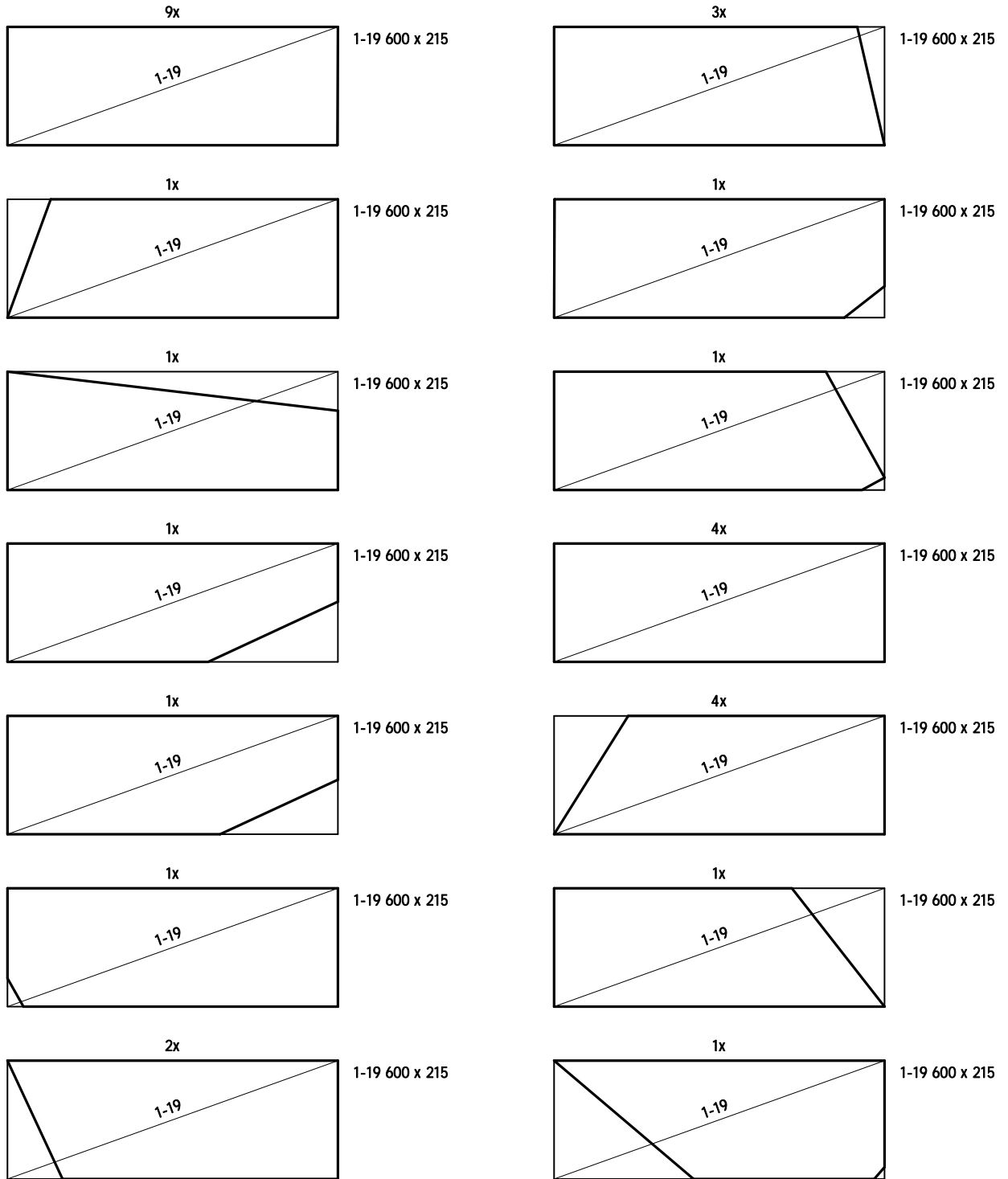

ISKAZ ARMATURE

GRAĐEVINA:	REKONSTRUKCIJA TERMALNOG REKREACIJSKOG CENTRA TERME TUHELJ
ISKAZ UZ NACRT:	ARM_E-2_301-308
SADRŽAJ:	ARMATURA STROPNE PLOČE -2
DATUM:	srpanj, 2023.

Mreže - plan rezanja

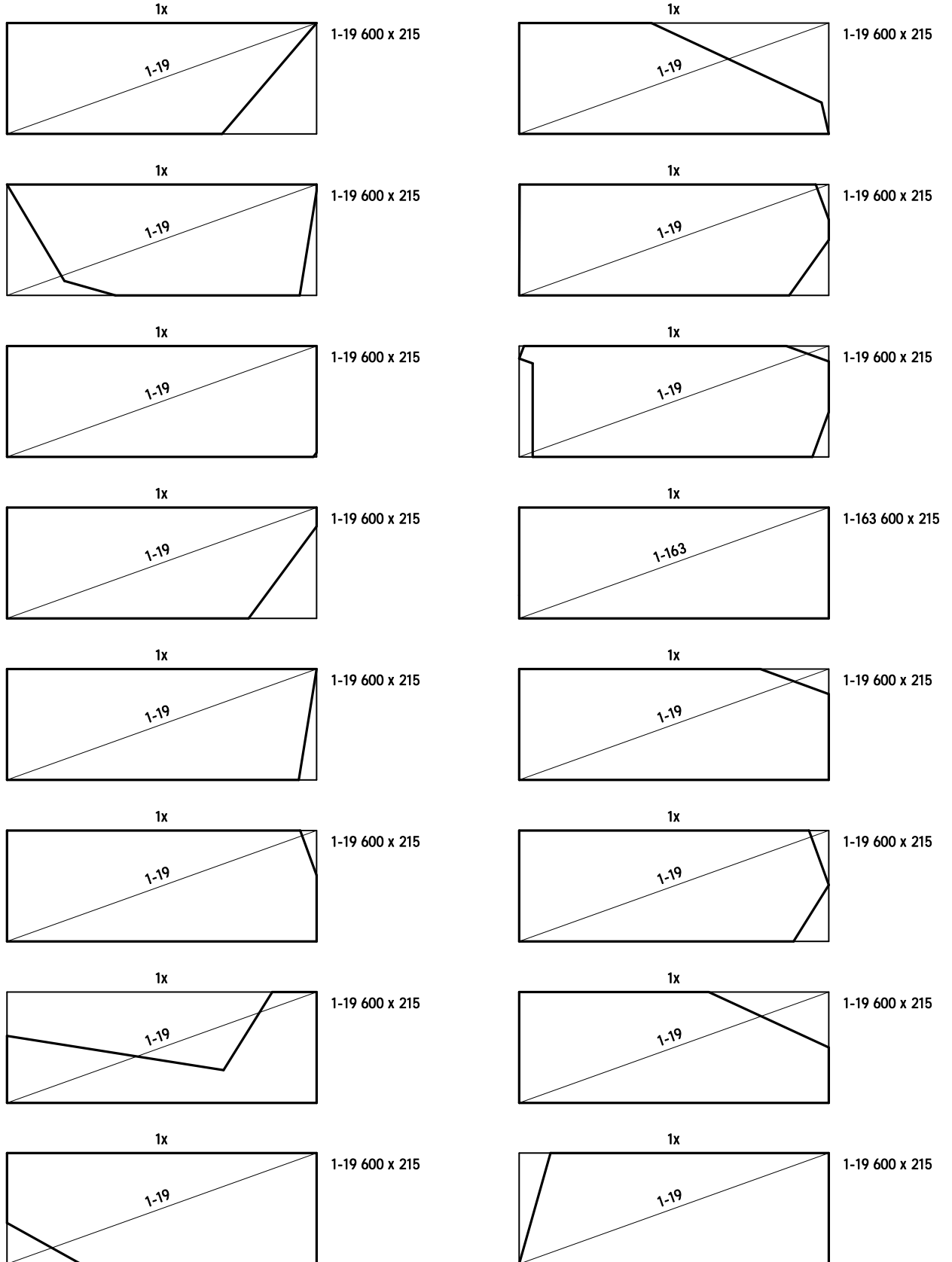

ISKAZ ARMATURE

GRAĐEVINA:	REKONSTRUKCIJA TERMALNOG REKREACIJSKOG CENTRA TERME TUHELJ
ISKAZ UZ NACRT:	ARM_E-2_301-308
SADRŽAJ:	ARMATURA STROPNE PLOČE -2
DATUM:	srpanj, 2023.

Mreže - plan rezanja

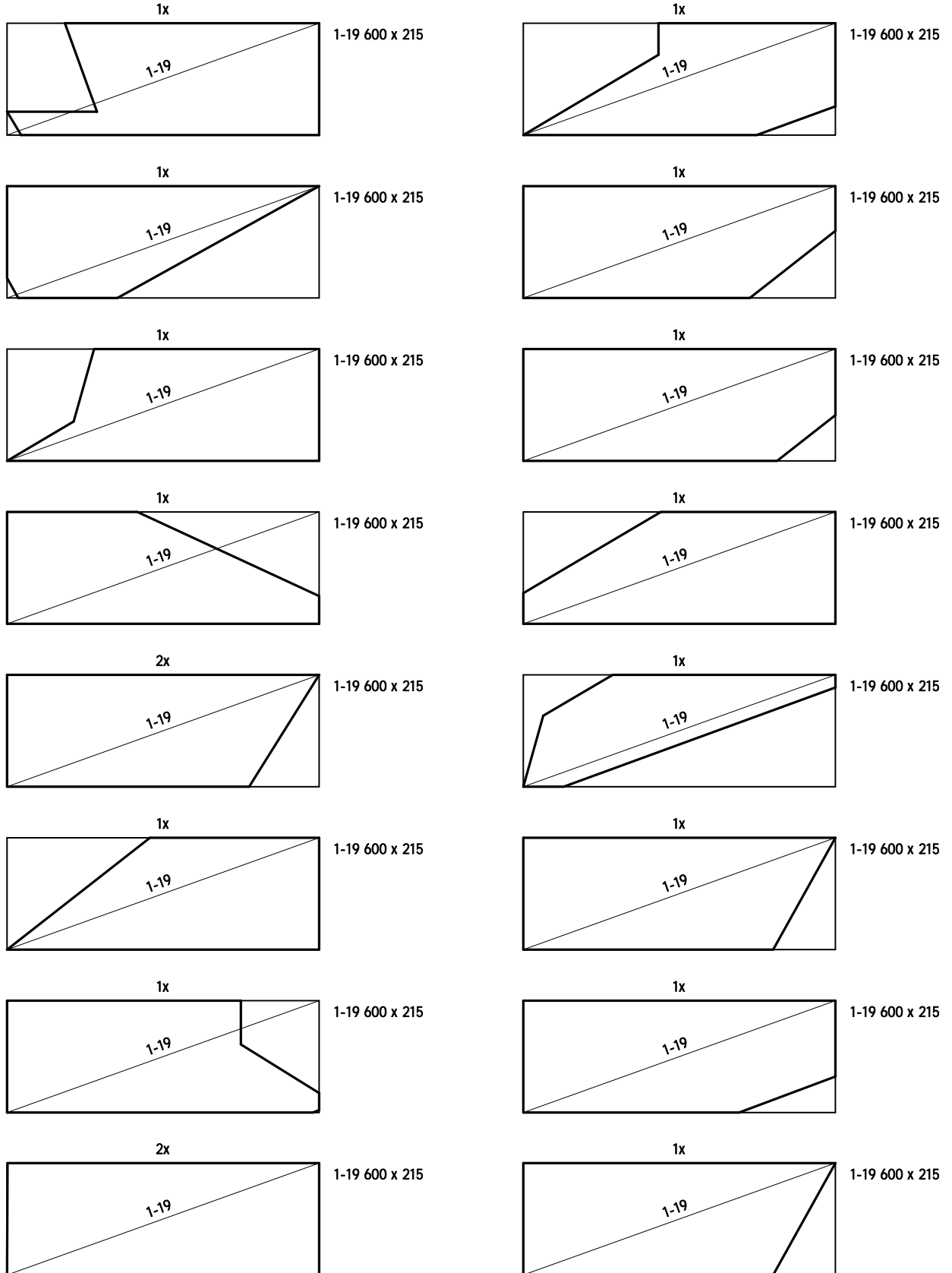

ISKAZ ARMATURE

GRAĐEVINA:	REKONSTRUKCIJA TERMALNOG REKREACIJSKOG CENTRA TERME TUHELJ
ISKAZ UZ NACRT:	ARM_E-2_301-308
SADRŽAJ:	ARMATURA STROPNE PLOČE -2
DATUM:	srpanj, 2023.

Mreže - plan rezanja

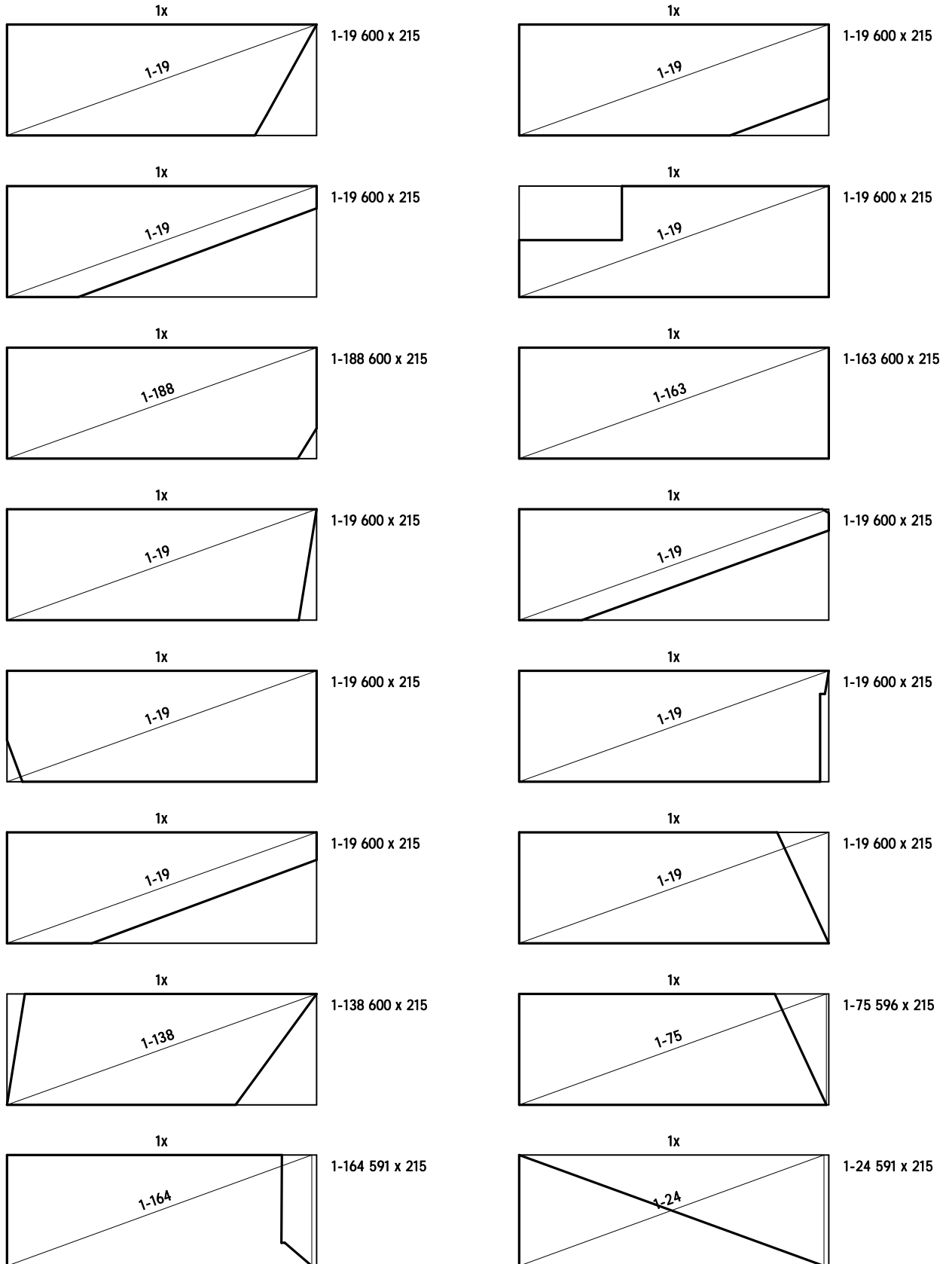

ISKAZ ARMATURE

GRAĐEVINA:	REKONSTRUKCIJA TERMALNOG REKREACIJSKOG CENTRA TERME TUHELJ
ISKAZ UZ NACRT:	ARM_E-2_301-308
SADRŽAJ:	ARMATURA STROPNE PLOČE -2
DATUM:	srpanj, 2023.

Mreže - plan rezanja

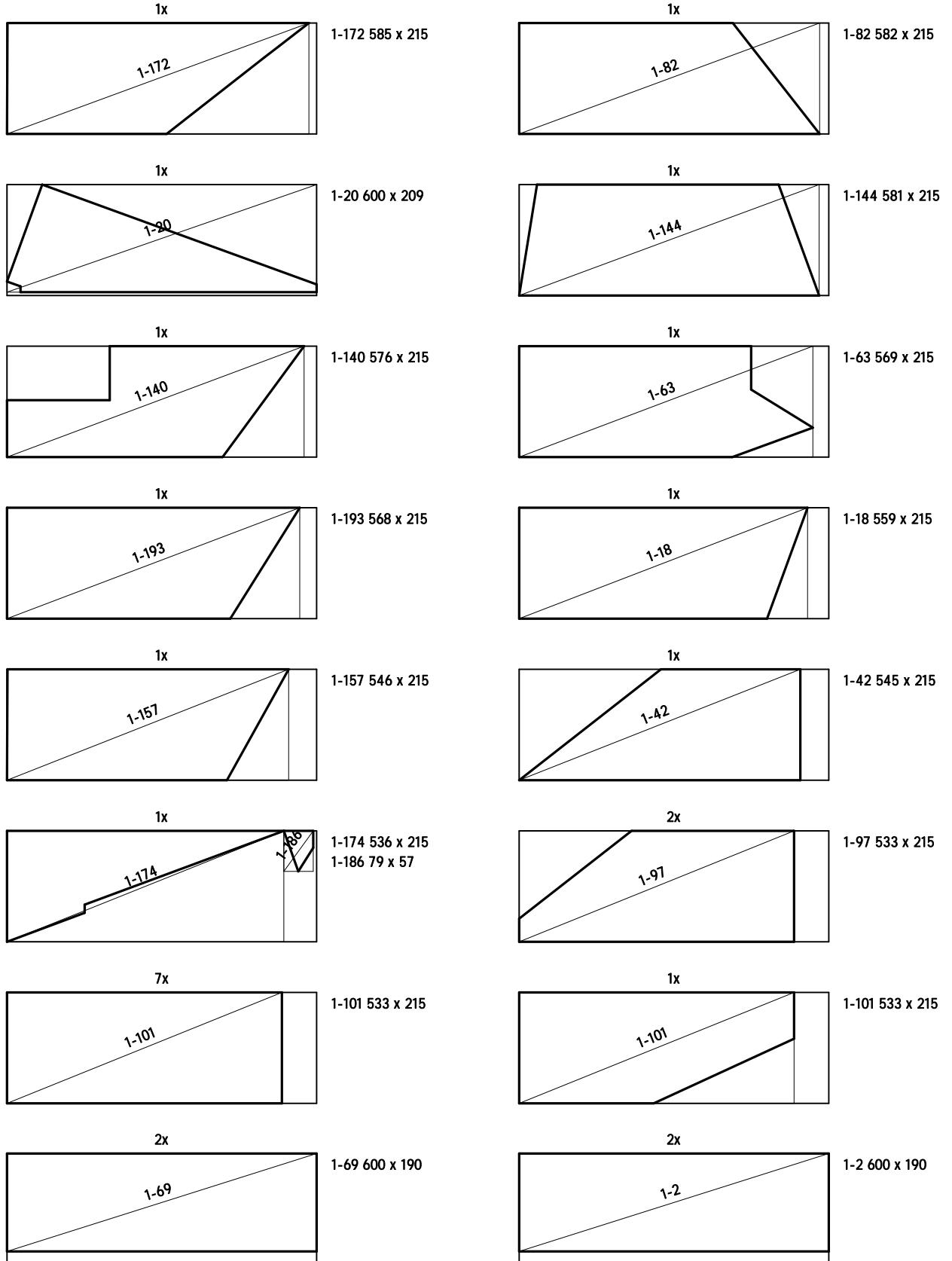

ISKAZ ARMATURE

GRAĐEVINA:	REKONSTRUKCIJA TERMALNOG REKREACIJSKOG CENTRA TERME TUHELJ
ISKAZ UZ NACRT:	ARM_E-2_301-308
SADRŽAJ:	ARMATURA STROPNE PLOČE -2
DATUM:	srpanj, 2023.

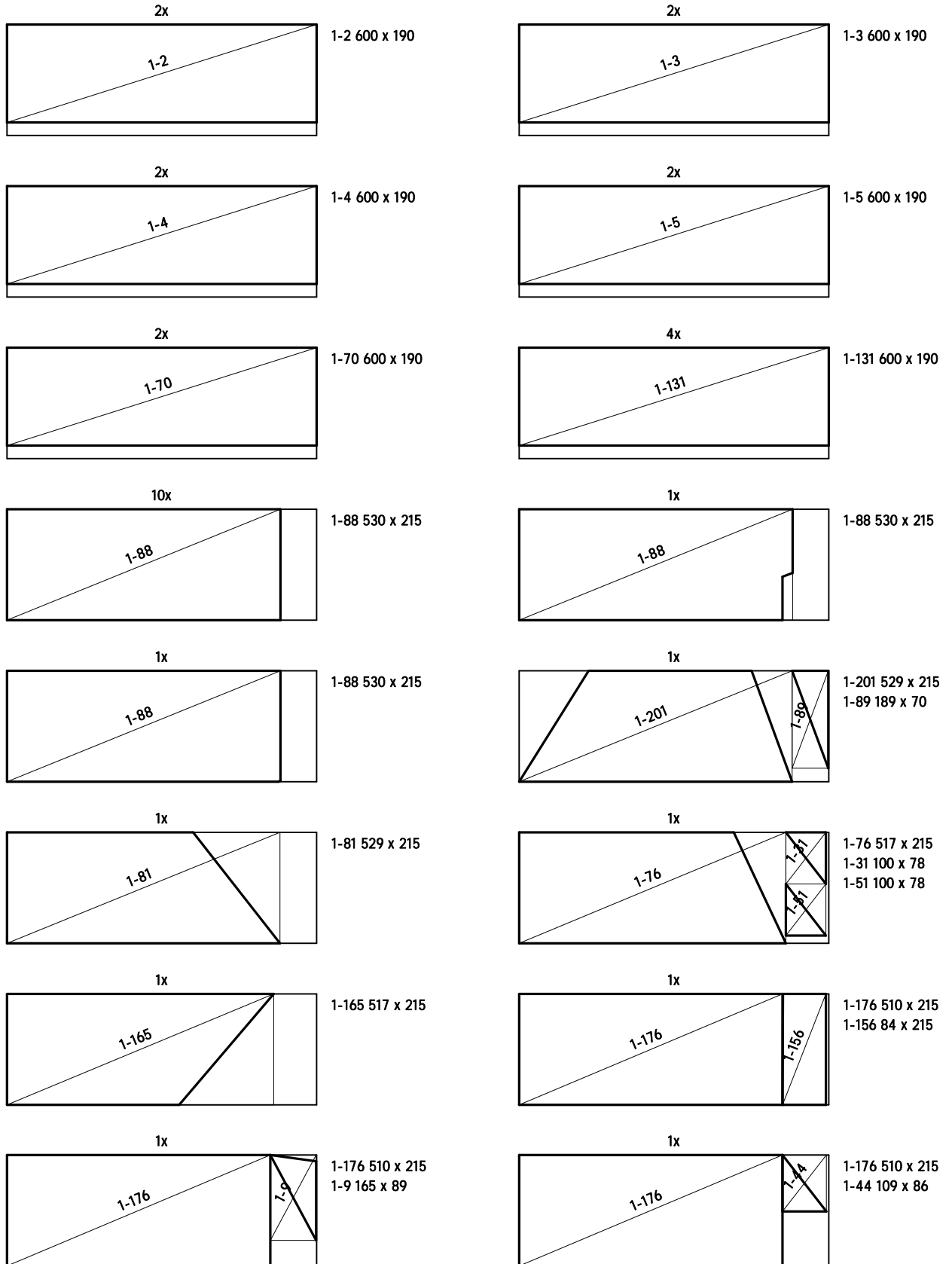

Mreže - plan rezanja



ISKAZ ARMATURE

GRAĐEVINA:	REKONSTRUKCIJA TERMALNOG REKREACIJSKOG CENTRA TERME TUHELJ
ISKAZ UZ NACRT:	ARM_E-2_301-308
SADRŽAJ:	ARMATURA STROPNE PLOČE -2
DATUM:	srpanj, 2023.

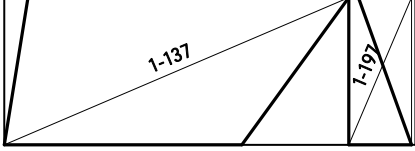
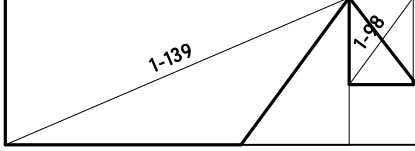
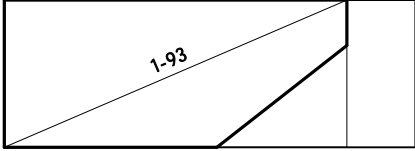
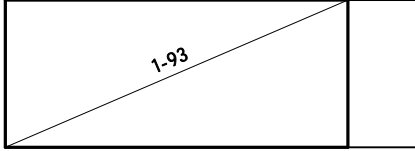
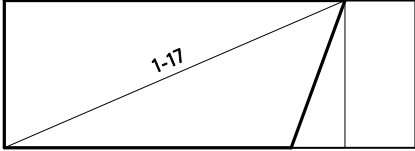
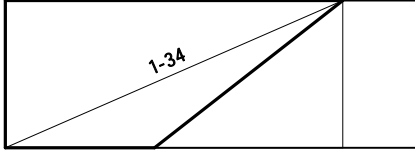
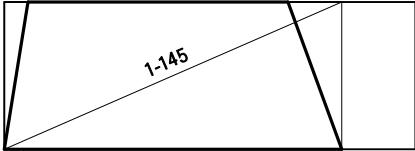
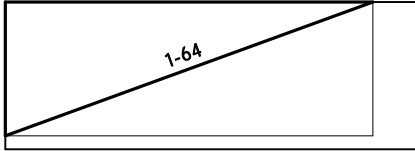
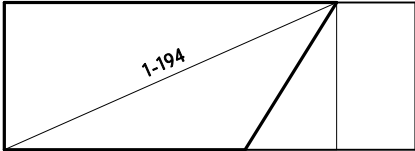
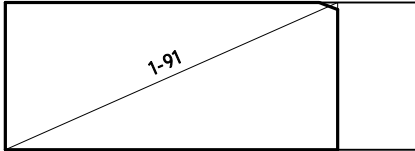
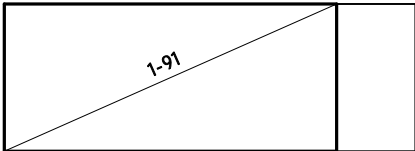
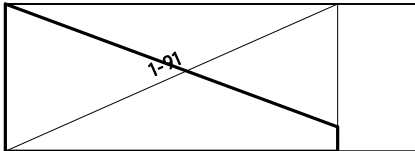
Mreže - plan rezanja

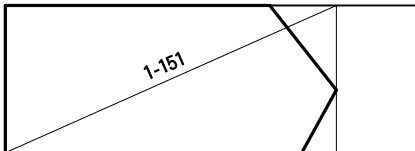
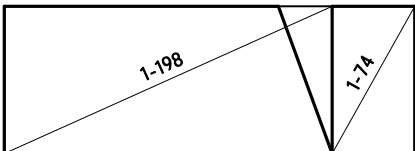
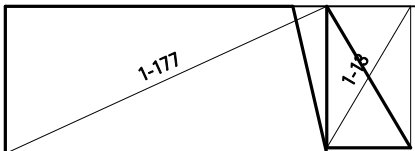
1x 	1-137 503 x 215 1-197 92 x 215	1x 	1-139 502 x 215 1-98 128 x 94
1x 	1-93 500 x 215	1x 	1-93 500 x 215
1x 	1-17 497 x 215	1x 	1-34 493 x 215
1x 	1-145 493 x 215	1x 	1-64 537 x 195
1x 	1-194 485 x 215	1x 	1-91 485 x 215
3x 	1-91 485 x 215	1x 	1-91 485 x 215
1x 	1-91 485 x 215	1x 	1-151 483 x 215
1x 	1-198 479 x 215 1-74 120 x 215	1x 	1-177 470 x 215 1-13 207 x 122

ISKAZ ARMATURE

GRAĐEVINA:	REKONSTRUKCIJA TERMALNOG REKREACIJSKOG CENTRA TERME TUHELJ
ISKAZ UZ NACRT:	ARM_E-2_301-308
SADRŽAJ:	ARMATURA STROPNE PLOČE -2
DATUM:	srpanj, 2023.

Mreže - plan rezanja

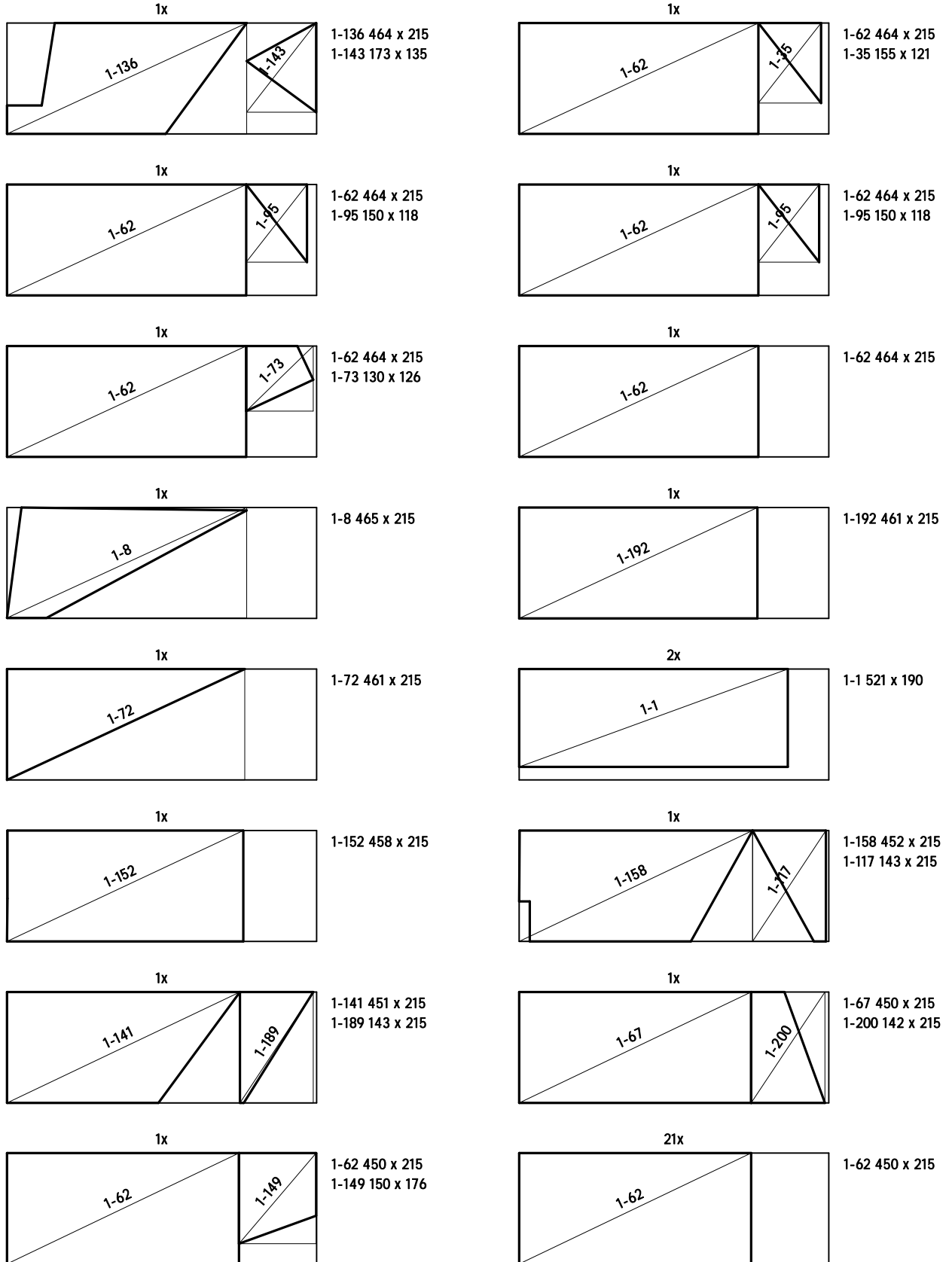

ISKAZ ARMATURE

GRAĐEVINA:	REKONSTRUKCIJA TERMALNOG REKREACIJSKOG CENTRA TERME TUHELJ
ISKAZ UZ NACRT:	ARM_E-2_301-308
SADRŽAJ:	ARMATURA STROPNE PLOČE -2
DATUM:	srpanj, 2023.

Mreže - plan rezanja

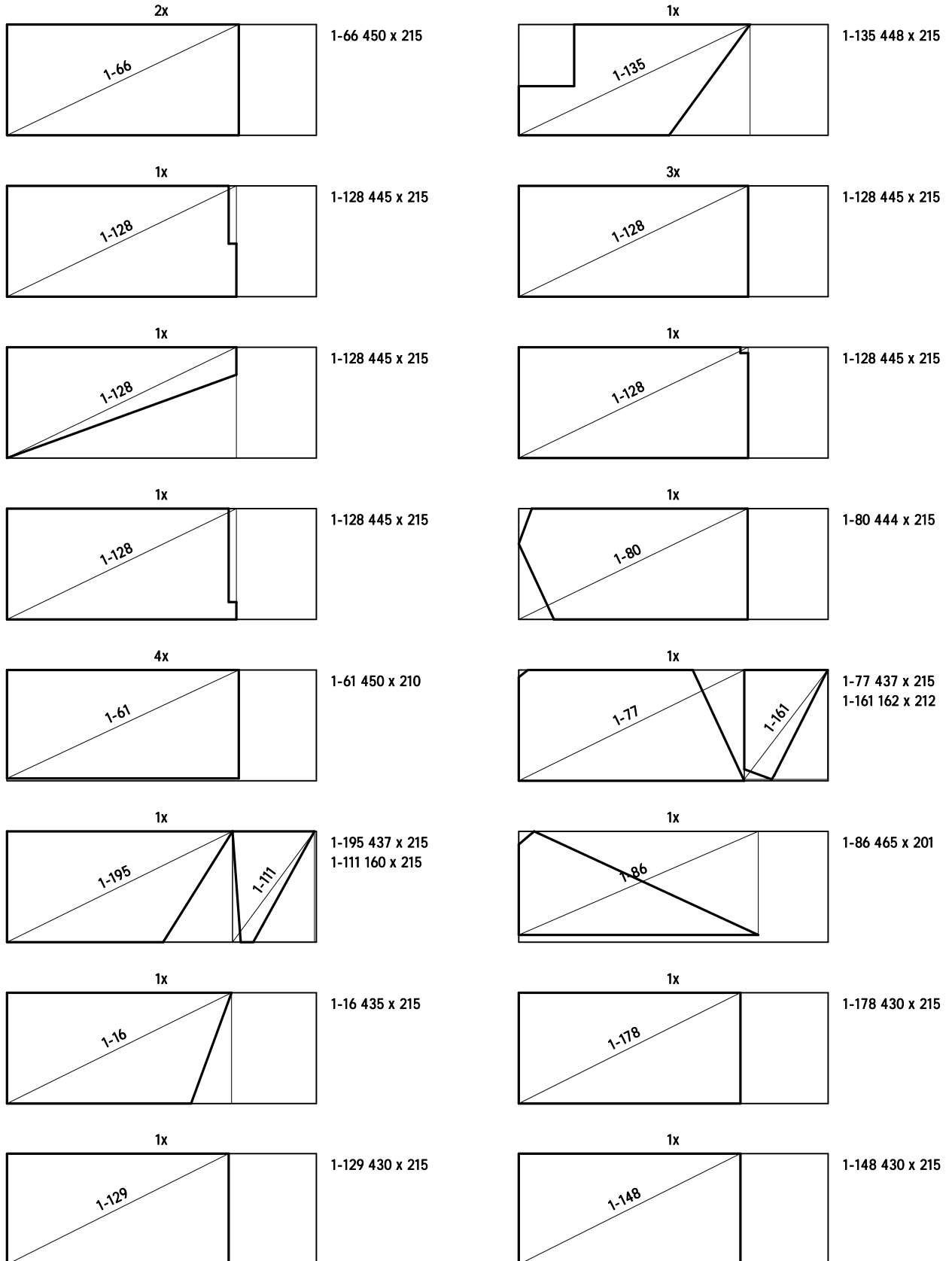

ISKAZ ARMATURE

GRAĐEVINA:	REKONSTRUKCIJA TERMALNOG REKREACIJSKOG CENTRA TERME TUHELJ
ISKAZ UZ NACRT:	ARM_E-2_301-308
SADRŽAJ:	ARMATURA STROPNE PLOČE -2
DATUM:	srpanj, 2023.

Mreže - plan rezanja

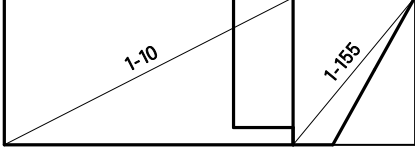
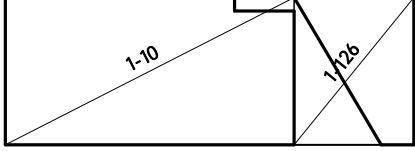
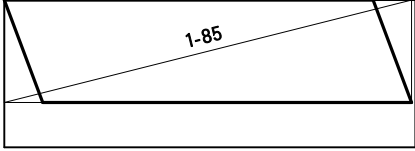
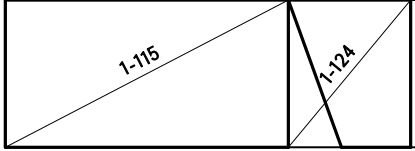
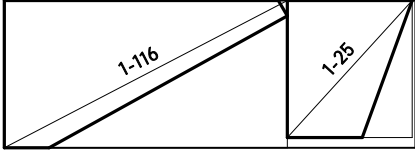
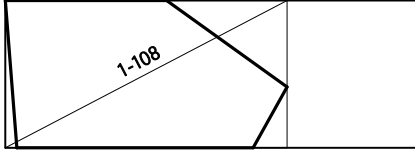
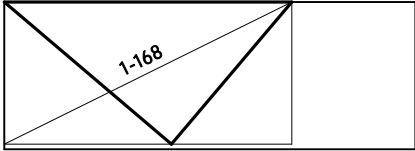
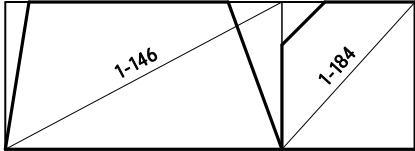
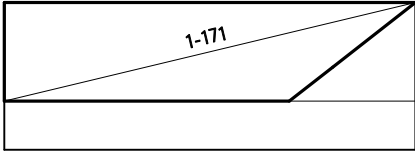
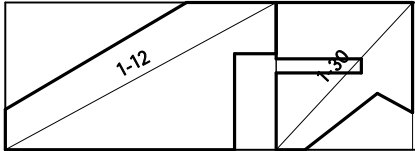
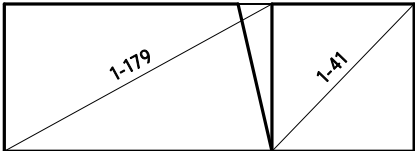
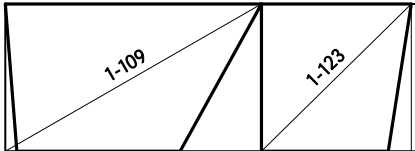
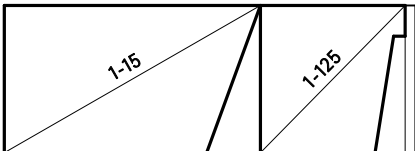
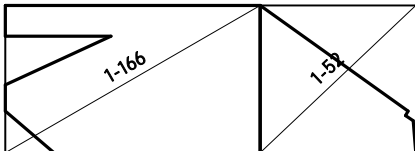
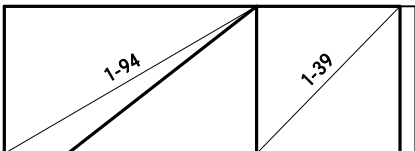
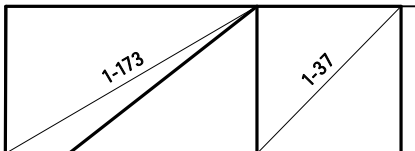
1x 	1-10 421 x 215 1-155 178 x 215	1x 	1-10 421 x 215 1-126 175 x 215
1x 	1-85 594 x 150	1x 	1-115 413 x 215 1-124 179 x 215
1x 	1-116 413 x 215 1-25 200 x 183	1x 	1-108 411 x 215
1x 	1-168 420 x 207	1x 	1-146 404 x 215 1-184 195 x 215
1x 	1-171 600 x 144	1x 	1-12 395 x 215 1-30 200 x 215
1x 	1-179 391 x 215 1-41 207 x 215	1x 	1-109 374 x 215 1-123 219 x 215
1x 	1-15 374 x 215 1-125 211 x 215	1x 	1-166 372 x 215 1-52 227 x 215
1x 	1-94 368 x 215 1-39 210 x 215	1x 	1-173 368 x 215 1-37 210 x 215

ISKAZ ARMATURE

GRAĐEVINA:	REKONSTRUKCIJA TERMALNOG REKREACIJSKOG CENTRA TERME TUHELJ
ISKAZ UZ NACRT:	ARM_E-2_301-308
SADRŽAJ:	ARMATURA STROPNE PLOČE -2
DATUM:	srpanj, 2023.

Mreže - plan rezanja

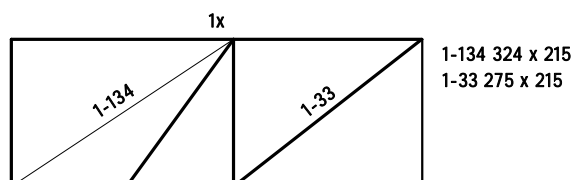
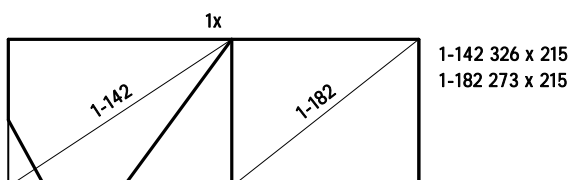
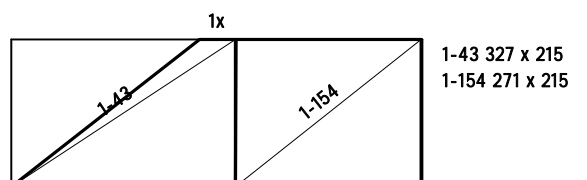
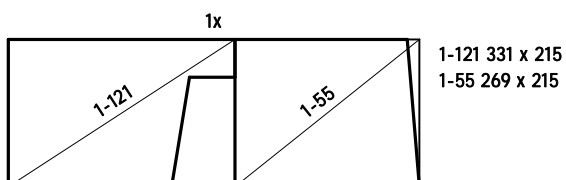
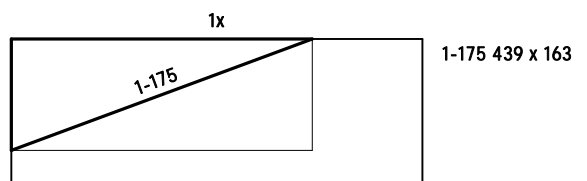
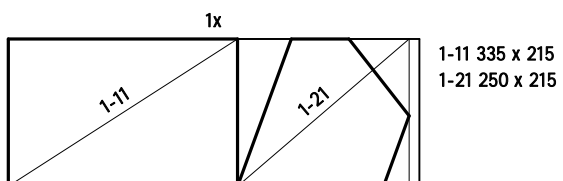
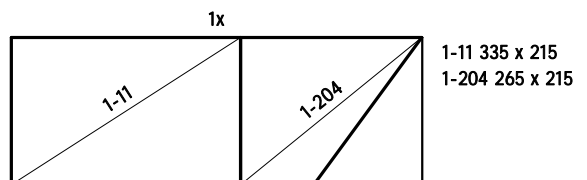
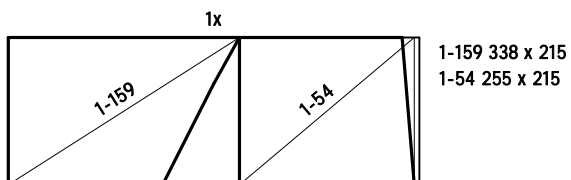
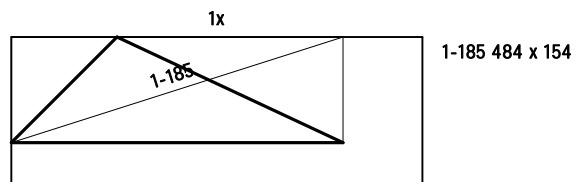
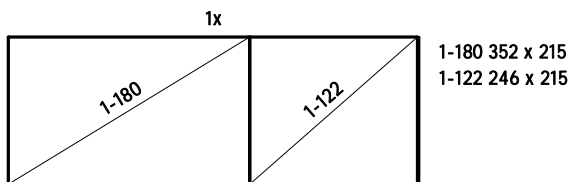
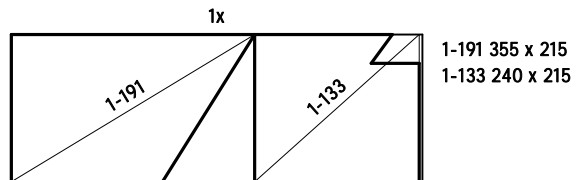
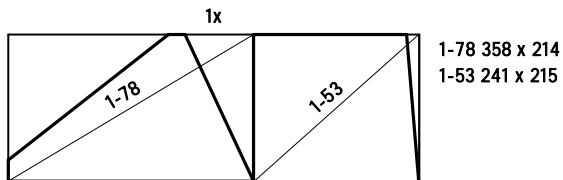
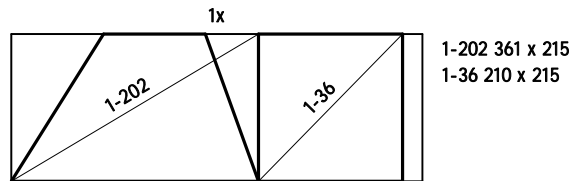
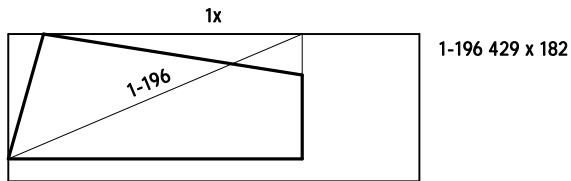
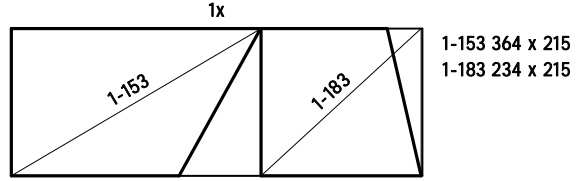
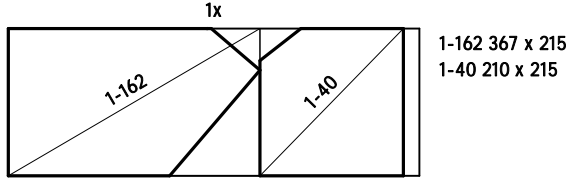

ISKAZ ARMATURE

GRAĐEVINA:	REKONSTRUKCIJA TERMALNOG REKREACIJSKOG CENTRA TERME TUHELJ
ISKAZ UZ NACRT:	ARM_E-2_301-308
SADRŽAJ:	ARMATURA STROPNE PLOČE -2
DATUM:	srpanj, 2023.

Mreže - plan rezanja

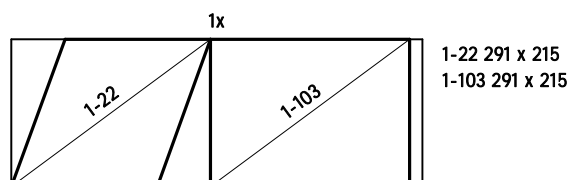
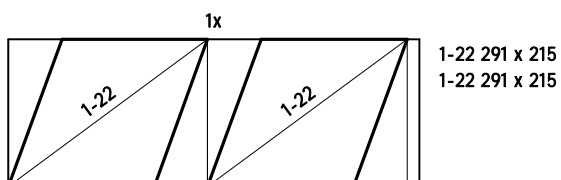
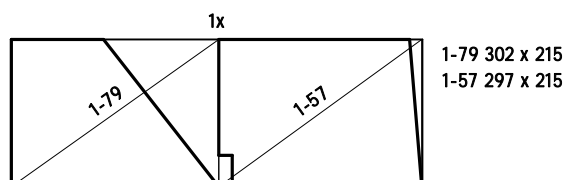
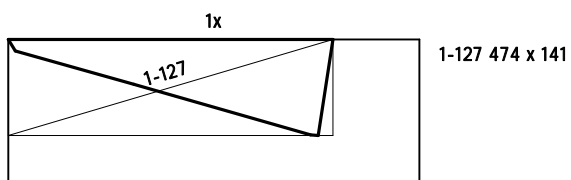
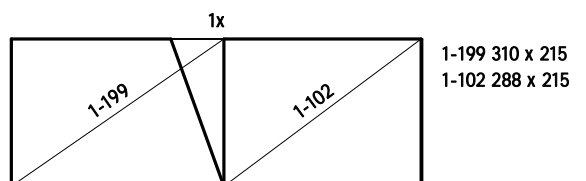
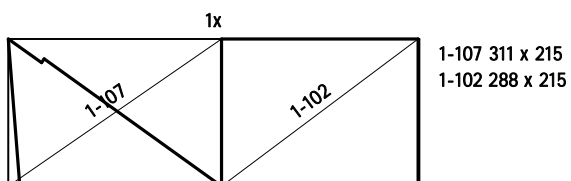
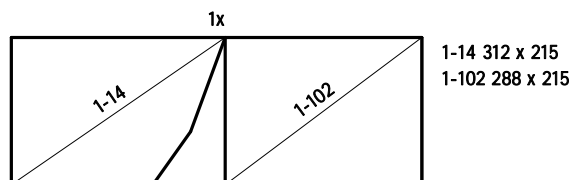
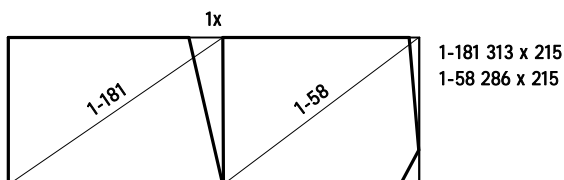
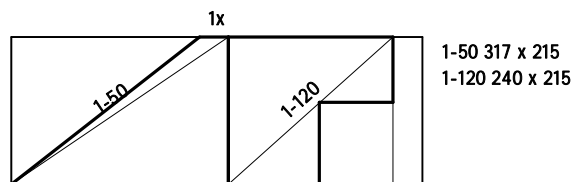
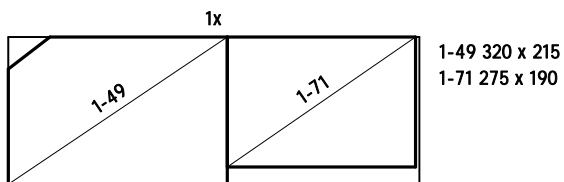
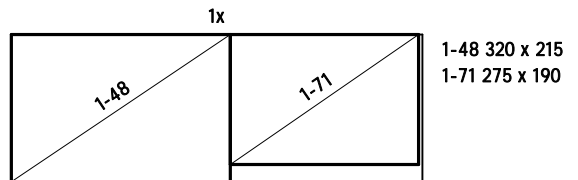
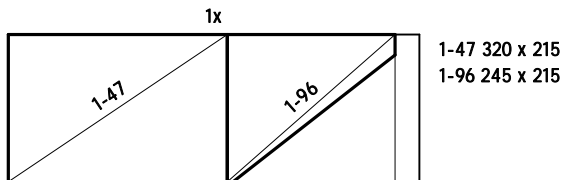
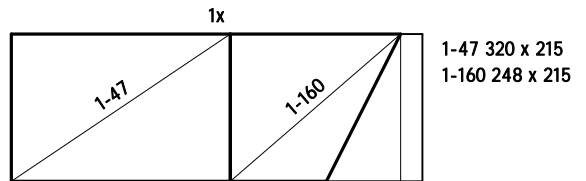
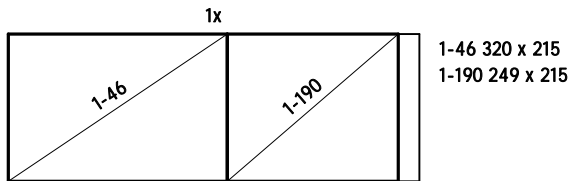
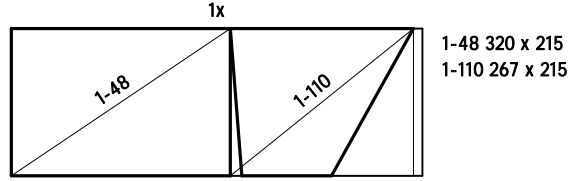
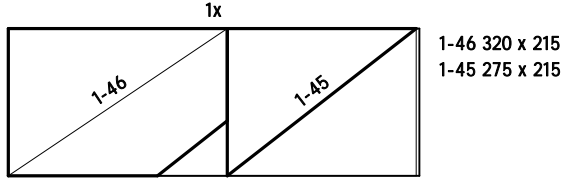

ISKAZ ARMATURE

GRAĐEVINA:	REKONSTRUKCIJA TERMALNOG REKREACIJSKOG CENTRA TERME TUHELJ
ISKAZ UZ NACRT:	ARM_E-2_301-308
SADRŽAJ:	ARMATURA STROPNE PLOČE -2
DATUM:	srpanj, 2023.

Mreže - plan rezanja

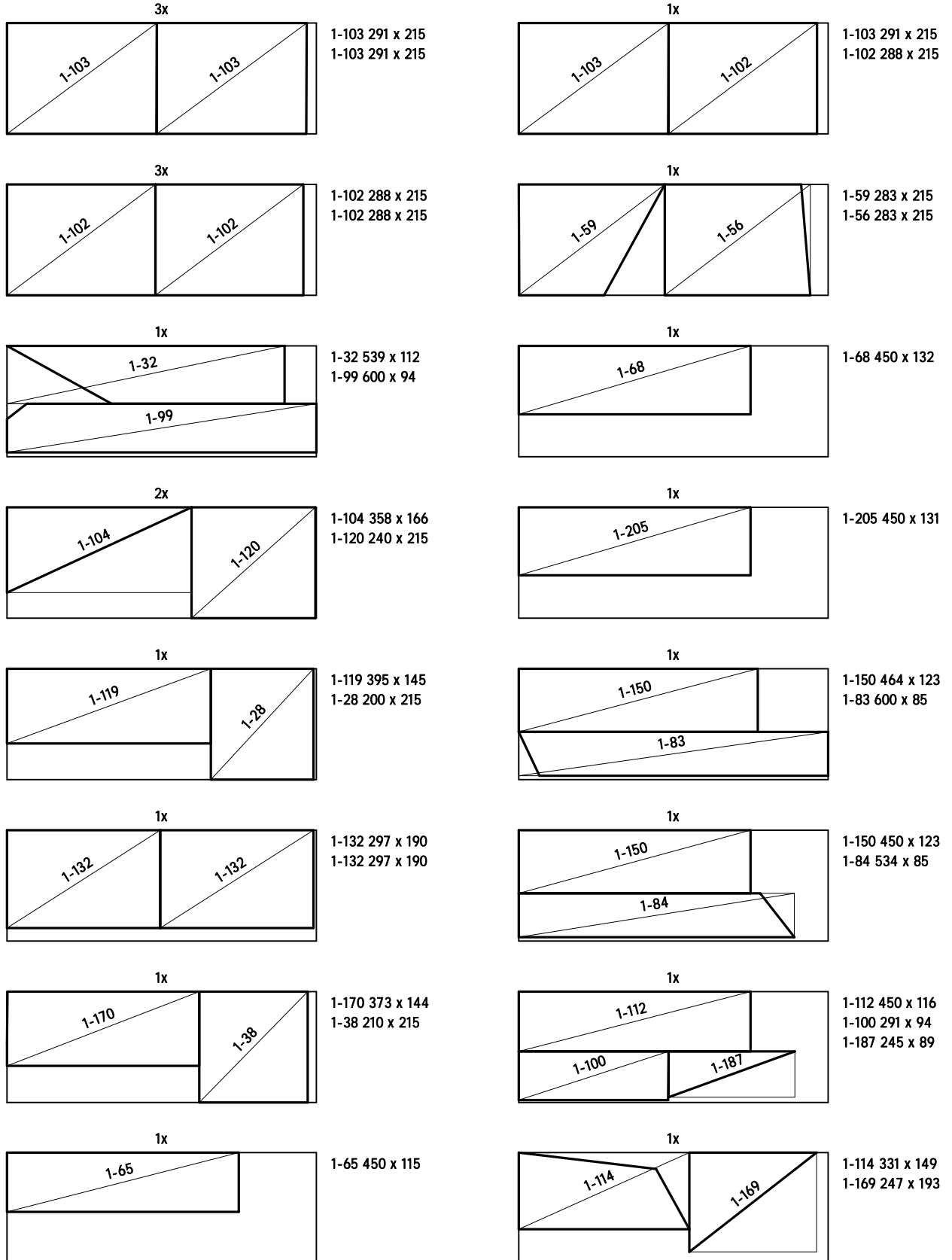

ISKAZ ARMATURE

GRAĐEVINA:	REKONSTRUKCIJA TERMALNOG REKREACIJSKOG CENTRA TERME TUHELJ
ISKAZ UZ NACRT:	ARM_E-2_301-308
SADRŽAJ:	ARMATURA STROPNE PLOČE -2
DATUM:	srpanj, 2023.

Mreže - plan rezanja

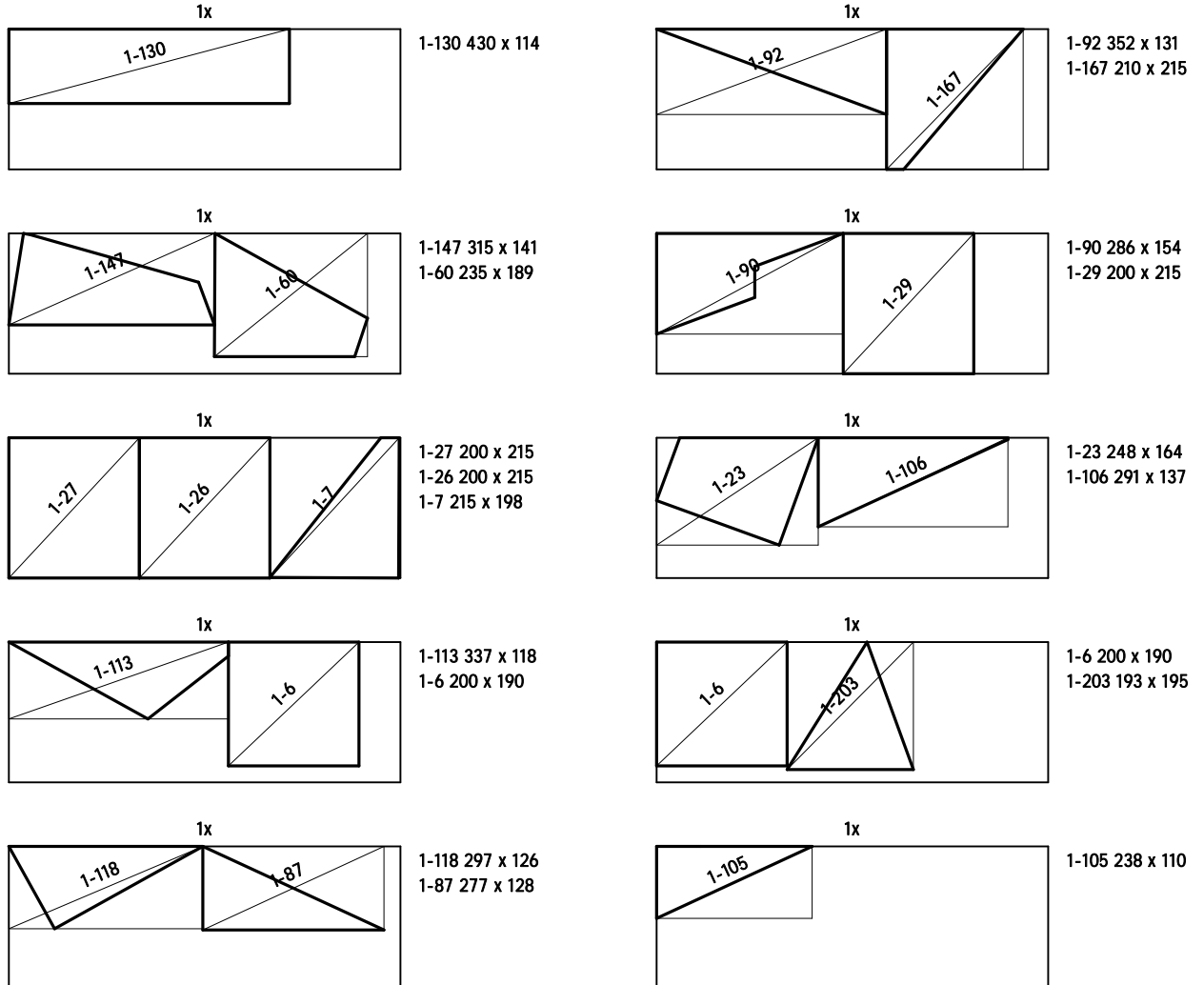

ARMATURA STUBIŠTA STROPNE PLOČE E-2 KOD OSI 3.1, M 1:50

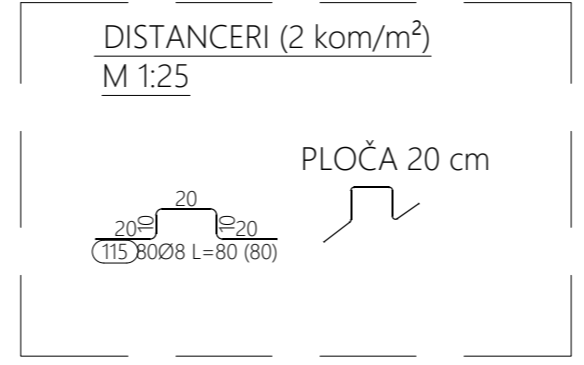
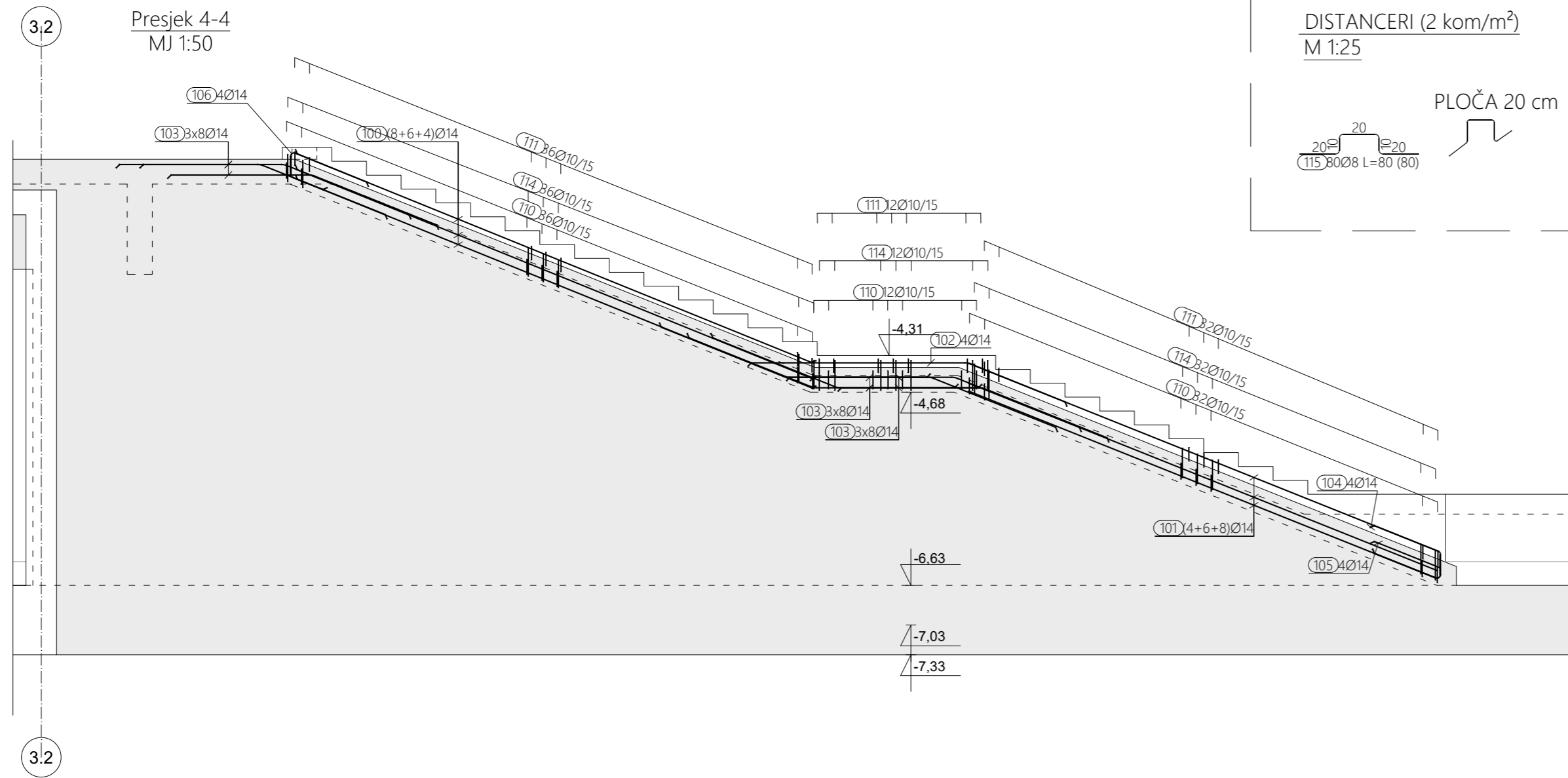
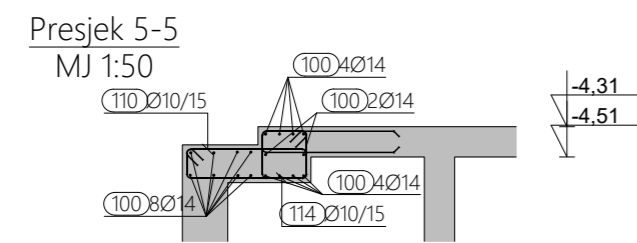
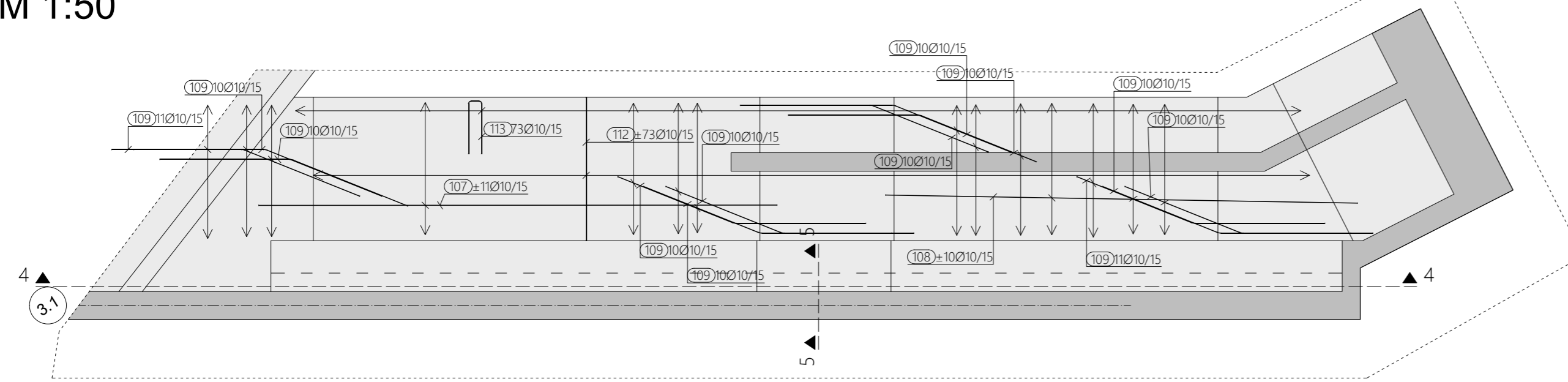

Šipke - specifikacija					
ozn.	oblik i mjere [cm]	Ø	lg [m]	n [kom]	lg _n [m]
STROPNA PLOČA E-2 - STUBIŠTE (1 kom)					
100	560	14	5.60	18	100.80
101	510	14	5.10	18	91.80
102	218	14	3.24	4	12.96
103	142	14	2.78	72	200.16
104	72	14	1.72	4	6.88
105	72	14	1.56	4	6.24
106	35	14	1.44	4	5.76
107	560	10	5.60	22	123.20
108	510	10	5.10	20	102.00
109	142	10	2.78	122	339.16
110	79	10	2.18	80	174.40
111	14	10	1.88	80	150.40
112	155	10	1.55	146	226.30
113	14	10	1.28	73	93.44
114	31	10	1.42	80	113.60
115	20	8	0.80	80	64.00

Šipke - rekapitulacija			
Ø [mm]	lg _n [m]	Jedinična težina [kg/m ³]	Težina [kg]
B500B			
8	64.00	0.40	25.28
10	1322.50	0.62	815.98
14	424.60	1.21	513.77
16	0.00	1.58	0.00
Ukupno (B500B)			1355.03
Ukupno			1355.03

NAPOMENA
Šipke prilagoditi i po potrebi rezati na licu mjesta. Preklap 50Ø.

NAPOMENA
Sve dimenzije provjeriti prema važećim planovima oplate.

Klasa betona	C 30/37		
Armatura	B 500 B		
Zaštitni sloj betona			
dolje	gore	bočno	Pripadajuća ista armature :
3,0 cm	3,0 cm	3,0 cm	ARM_E-2_309_ISKAZ
Pripadajući armaturni nacrti			
ARM_E-2_302-308			
ARM_E-2_321			

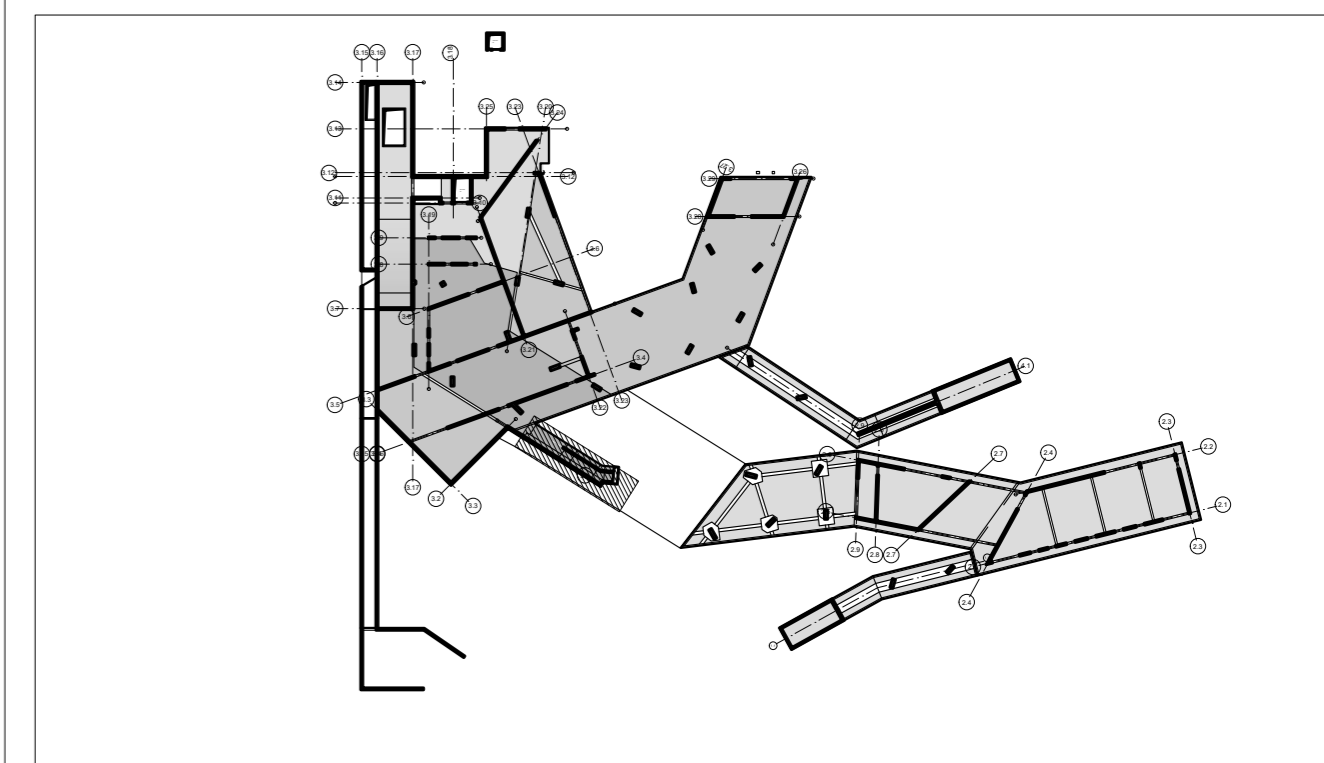

KONSTRUKTA PEČAT I POTPIS:

KONSTRUKTA d.o.o., za projektiranje i nadzor
Desinička 20, ZAGREB, OIB: 06674378579
ŽR: PRIVREDNA BANKA 2340009-1110164468
TEL: 01/36 43 828; FAX: 01/36 43 829
MAIL: info@konstrukta.hr

HRVATSKA KONGREGACIJA INŽINJERA GRAĐEVINARSTVA
Antonio Maglov
dipl. ing. građ.
Ovlašteni inženjer građevinarstva
3775

INVESTITOR:	TERME TUHELJ d.o.o. Ljudevita Gaja 4, Tuhejske Toplice, 49215 Tuhej	GL. PROJEKTANT:	Tomislav Vreš, dipl. ing. arh.
GRAĐEVINA:	REKONSTRUKCIJA TERMALNOG REKREACIJSKOG CENTRA TERME TUHELJ	PROJEKT. IZV. PR:	Antonio Maglov, dipl. ing. građ.
LOKACIJA:	na k.č.br. 3199/1, k.o. Črešnjevci	IZRADIO:	Antonio Maglov, dipl. ing. građ.
FAZA:	IZVEDBENI PROJEKT - ARMATURNI NACRTI	DATUM:	srpanj, 2023.
SADRŽAJ:	ELEMENT - PLOČA E-2 DILATACIJA 3 ARMATURA STUBIŠTA KOD OSI 3.1	MJERILO:	1:50; 1:25 REVIZIJA: 00
		NACRT BR:	ARM - E-2 - 309

ISKAZ ARMATURE

GRAĐEVINA:	REKONSTRUKCIJA TERMALNOG REKREACIJSKOG CENTRA TERME TUHELJ
ISKAZ UZ NACRT:	E-2_309
SADRŽAJ:	ARMATURA STUBIŠTA KOD OSI 3.1.
DATUM:	srpanj, 2023.

Šipke - specifikacija						
ozn	oblik i mjere [cm]	Ø	lg [m]	n [kom]	lgn [m]	Napomena
STROPNA PLOČA E-2 - STUBIŠTE (1 kom)						
100		14	5.60	18	100.80	
101		14	5.10	18	91.80	
102		14	3.24	4	12.96	
103		14	2.78	72	200.16	
104		14	1.72	4	6.88	
105		14	1.56	4	6.24	
106		14	1.44	4	5.76	
107		10	5.60	22	123.20	
108		10	5.10	20	102.00	
109		10	2.78	122	339.16	
110		10	2.18	80	174.40	
111		10	1.88	80	150.40	
112		10	1.55	146	226.30	
113		10	1.28	73	93.44	

ISKAZ ARMATURE

GRAĐEVINA:	REKONSTRUKCIJA TERMALNOG REKREACIJSKOG CENTRA TERME TUHELJ
ISKAZ UZ NACRT:	E-2_309
SADRŽAJ:	ARMATURA STUBIŠTA KOD OSI 3.1.
DATUM:	srpanj, 2023.

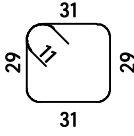
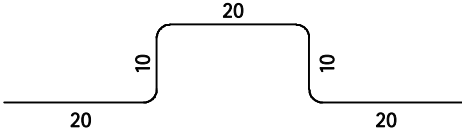
Šipke - specifikacija						
ozn	oblik i mjere [cm]	Ø	lg [m]	n [kom]	lgn [m]	Napomena
114		10	1.42	80	113.60	
115		8	0.80	80	64.00	

ISKAZ ARMATURE	
GRAĐEVINA:	REKONSTRUKCIJA TERMALNOG REKREACIJSKOG CENTRA TERME TUHELJ
ISKAZ UZ NACRT:	E-2_309
SADRŽAJ:	ARMATURA STUBIŠTA KOD OSI 3.1.
DATUM:	srpanj, 2023.

Šipke - rekapitulacija			
Ø [mm]	lgn [m]	Jedinična težina [kg/m ¹]	Težina [kg]
B500B			
8	64.00	0.40	25.28
10	1322.50	0.62	815.98
14	424.60	1.21	513.77
16	0.00	1.58	0.00
Ukupno (B500B)			1355.03
Ukupno			1355.03

NACRT SAVIJANJA ARMATURE ZIDOVA, DILATACIJA 3

ARMATURA ZIDA U OSI 3.4
M 1:50

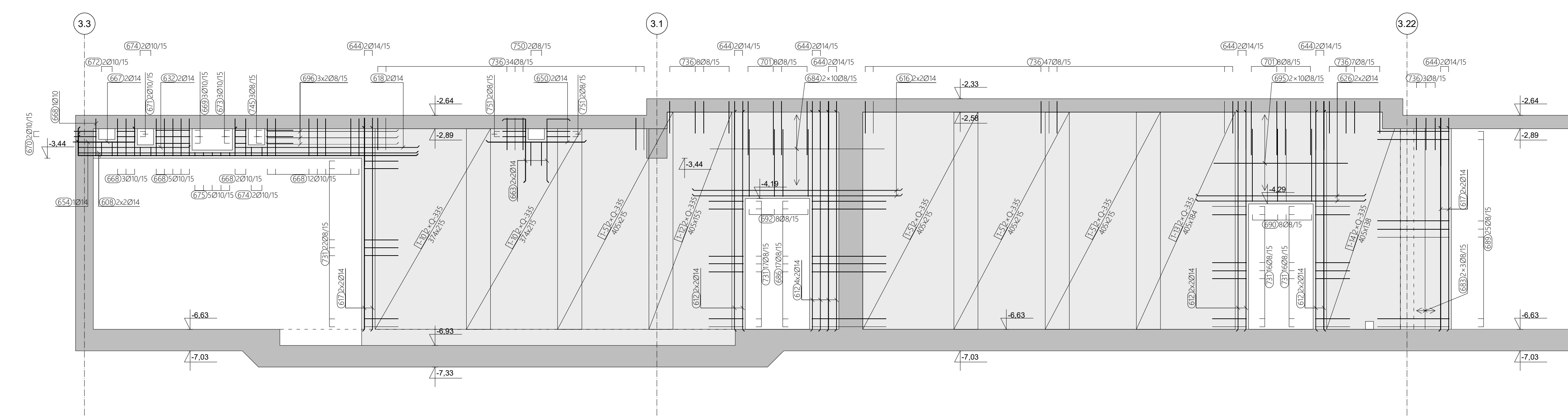

ARMATURA ZIDA U OSI 3.28
M 1:50

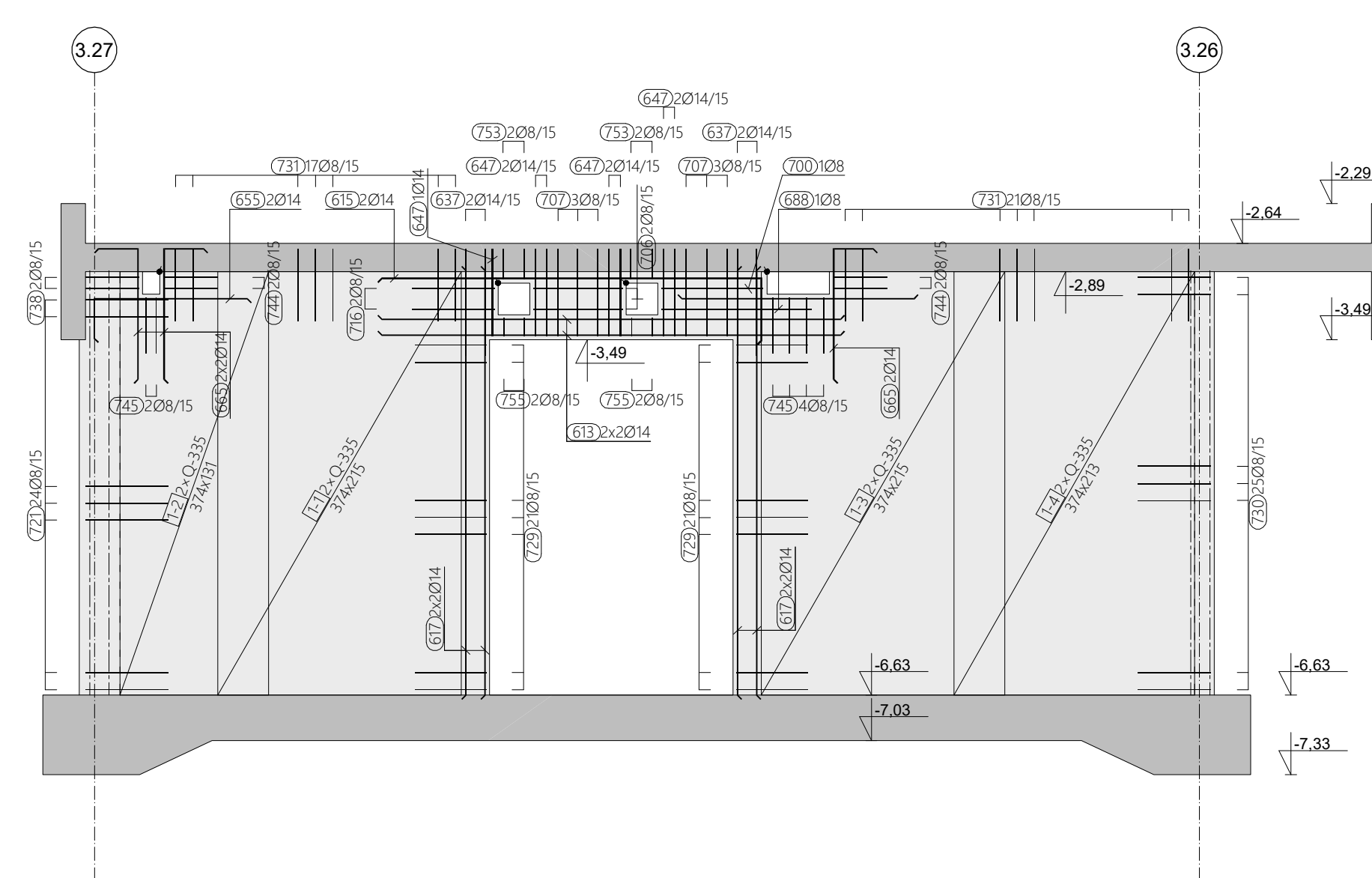

ARMATURA ZIDA U OSI 3.21
M 1:50

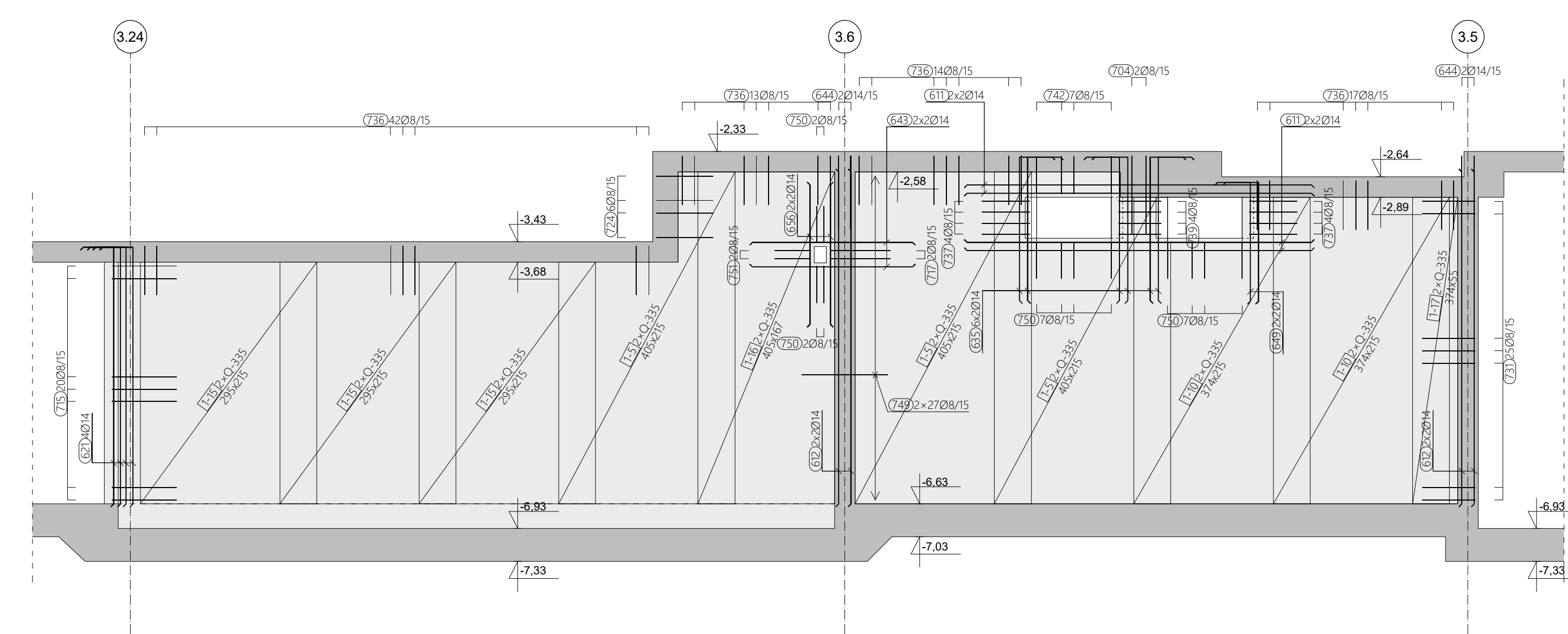

ARMATURA ZIDA U OSI 3.22
M 1:50

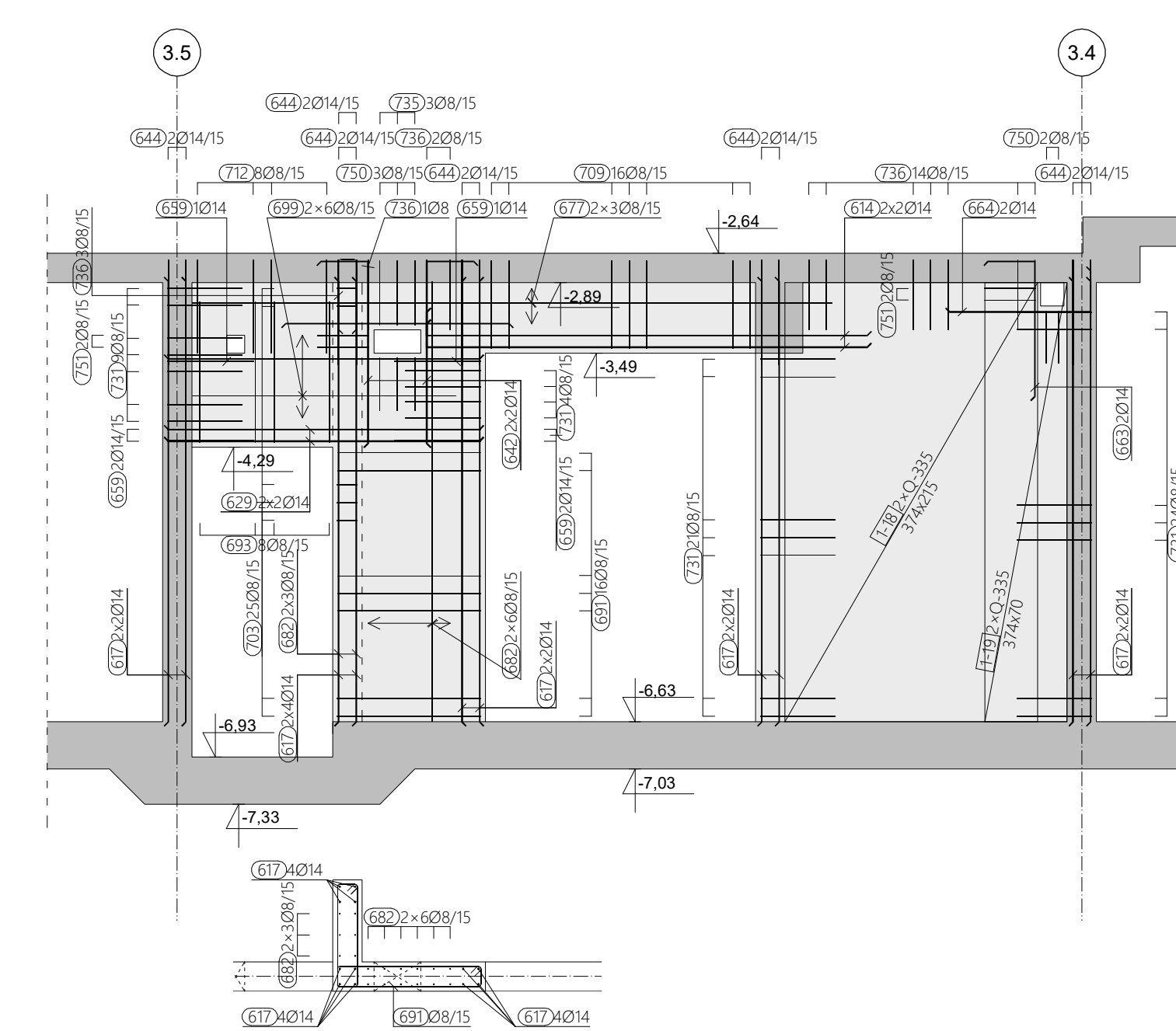

ARMATURA ZIDA U OSI 3.26
M 1:50

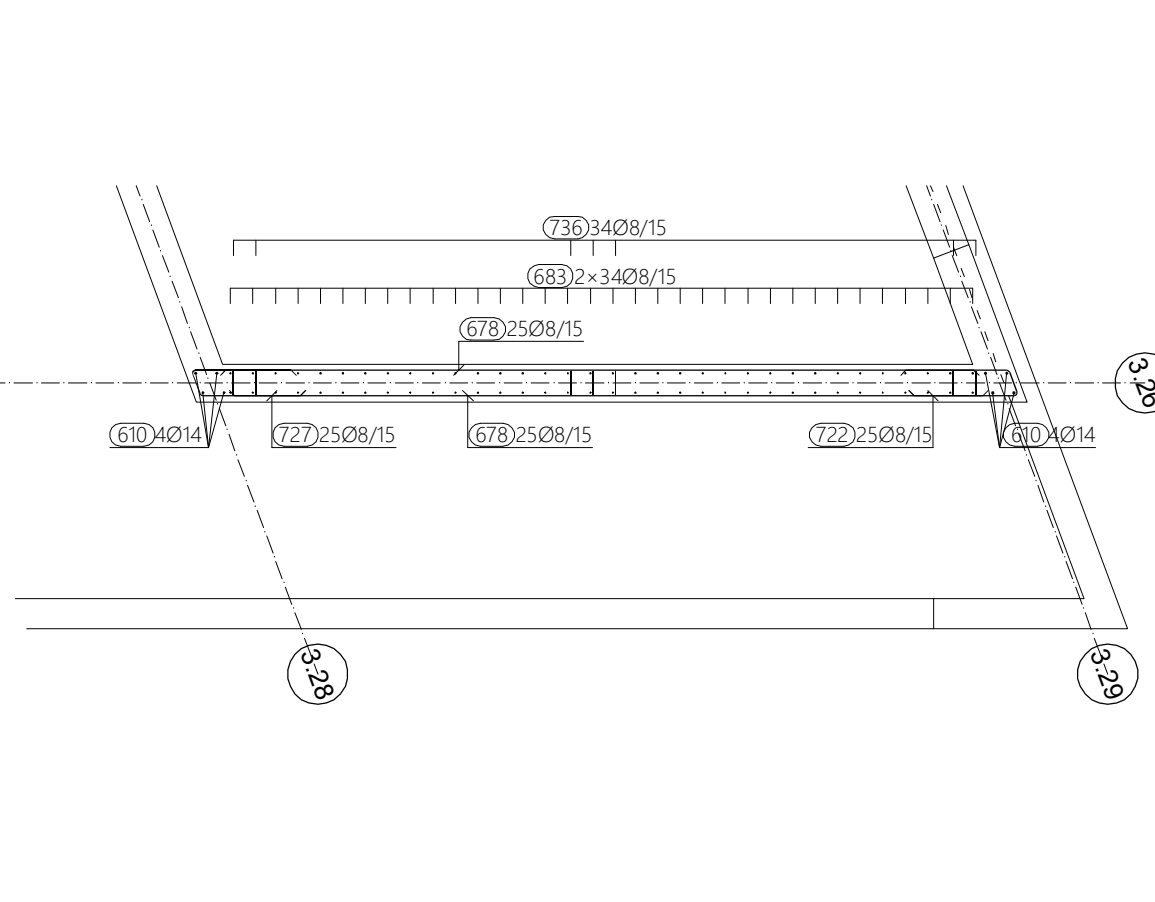

ARMATURA ZIDA U OSI 3.5
M 1:50

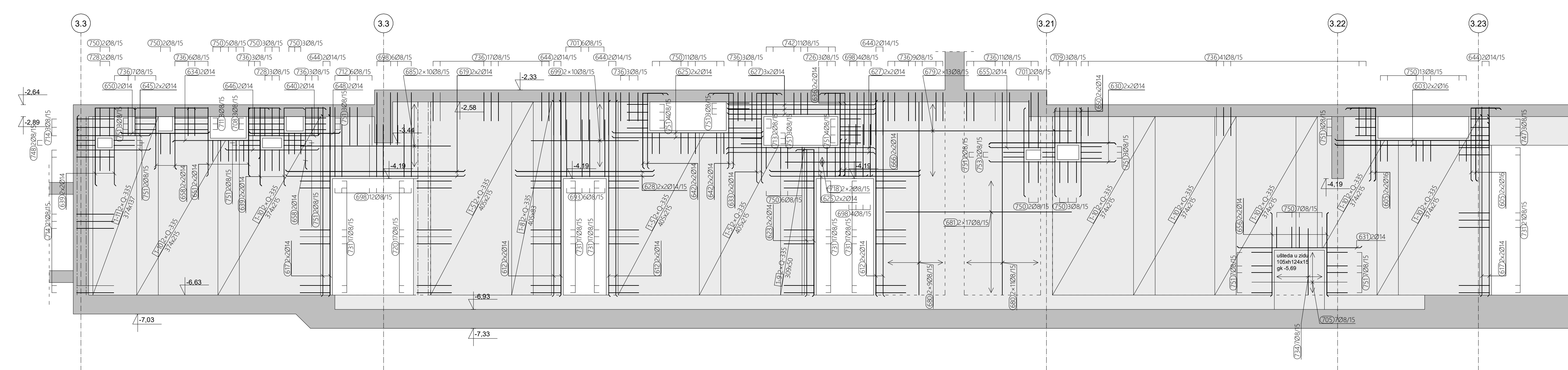

PREGLEDNI NACRT M 1:300

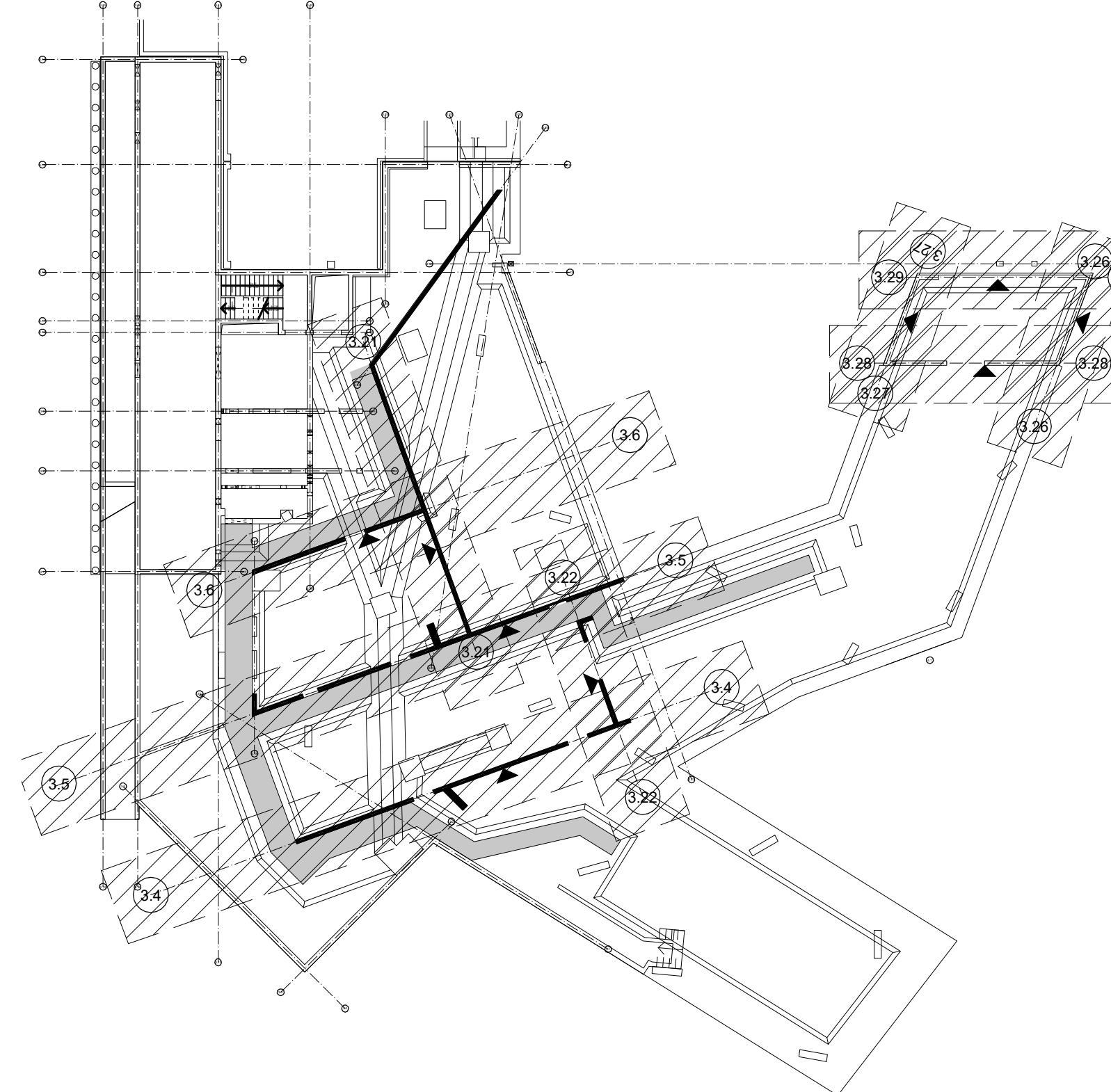

ARMATURA ZIDA U OSI 3.6
M 1:50

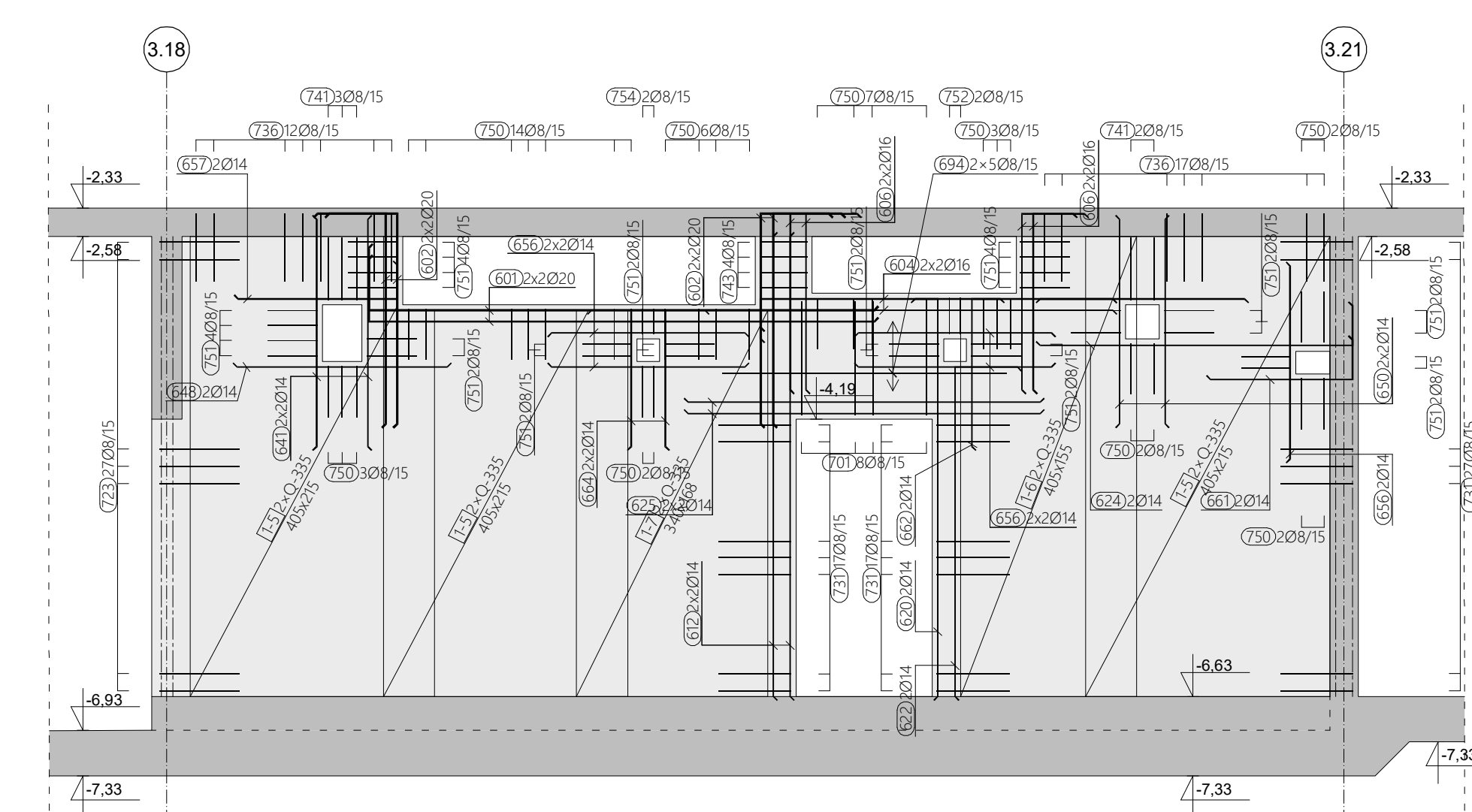

ARMATURA ZIDA U OSI 3.29
M 1:50

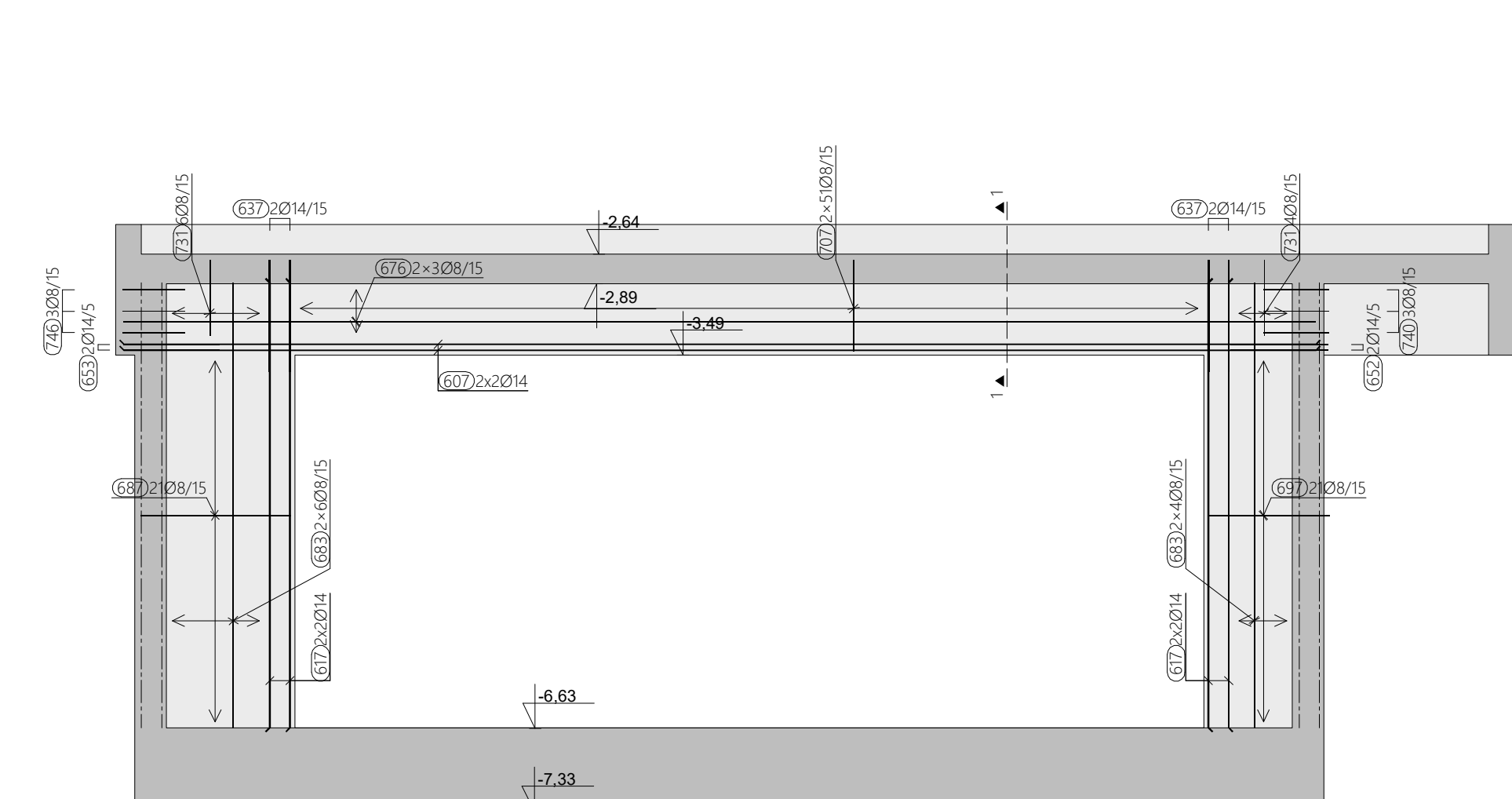

ARMATURA ZIDA U OSI 3.27
M 1:50

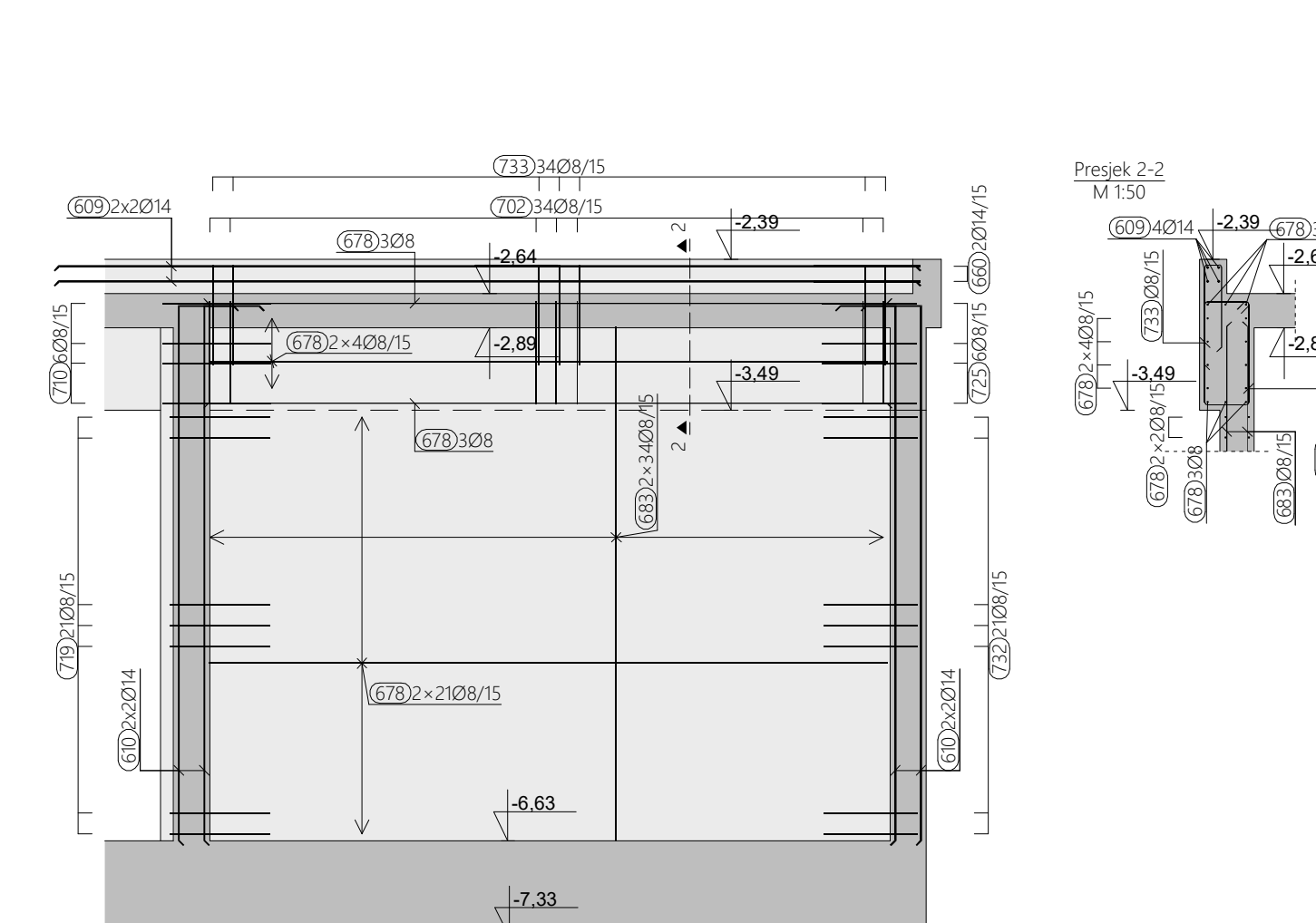

Redni broj	Specifikacija	Opis	Opis	Opis	Opis	Opis
601	10	14	3.75	2	7.50	
602	10	14	3.75	2	7.50	
603	10	14	3.75	2	7.50	
604	10	14	3.75	2	7.50	
605	10	14	3.75	2	7.50	
606	10	14	3.75	2	7.50	
607	10	14	3.75	2	7.50	
608	10	14	3.75	2	7.50	
609	10	14	3.75	2	7.50	
610	10	14	3.75	2	7.50	
611	10	14	3.75	2	7.50	
612	10	14	3.75	2	7.50	
613	10	14	3.75	2	7.50	
614	10	14	3.75	2	7.50	
615	10	14	3.75	2	7.50	
616	10	14	3.75	2	7.50	
617	10	14	3.75	2	7.50	
618	10	14	3.75	2	7.50	
619	10	14	3.75	2	7.50	
620	10	14	3.75	2	7.50	
621	10	14	3.75	2	7.50	
622	10	14	3.75	2	7.50	
623	10	14	3.75	2	7.50	
624	10	14	3.75	2	7.50	
625	10	14	3.75	2	7.50	
626	10	14	3.75	2	7.50	
627	10	14	3.75	2	7.50	
628	10	14	3.75	2	7.50	
629	10	14	3.75	2	7.50	
630	10	14	3.75	2	7.50	
631	10	14	3.75	2	7.50	
632	10	14	3.75	2	7.50	
633	10	14	3.75	2	7.50	
634	10	14	3.75	2	7.50	
635	10	14	3.75	2	7.50	
636	10	14	3.75	2	7.50	
637	10	14	3.75	2	7.50	
638	10	14	3.75	2	7.50	
639	10	14	3.75	2	7.50	
640	10	14	3.75	2	7.50	
641	10	14	3.75	2	7.50	
642	10	14	3.75	2	7.50	
643	10	14	3.75	2	7.50	
644	10	14	3.75	2	7.50	
645	10	14	3.75	2	7.50	
646	10	14	3.75	2	7.50	
647	10	14	3.75	2	7.50	
648	10	14	3.75	2	7.50	
649	10	14	3.75	2	7.50	
650	10	14	3.75	2	7.50	
651	10	14	3.75	2	7.50	
652	10	14	3.75	2	7.50	
653	10	14	3.75	2	7.50	
654	10	14	3.75	2	7.50	
655	10	14	3.75	2	7.50	
656	10	14	3.75	2	7.50	
657	10	14	3.75	2	7.50	
658	10	14	3.75	2	7.50	
659	10	14	3.75	2	7.50	
660	10	14	3.75	2	7.50	
661	10	14	3.75	2	7.50	
662	10	14	3.75	2	7.50	
663	10	14	3.75	2	7.50	
664	10	14	3.75	2	7.50	
665	10	14	3.75	2	7.50	
666	10	14	3.75	2	7.50	
667	10	14	3.75	2	7.50	
668	10	14	3.75	2	7.50	
669	10	14	3.75	2	7.50	
670	10	14	3.75	2	7.50	
671	10	14	3.75	2	7.50	
672	10	14	3.75	2	7.50	
673	10	14	3.75	2	7.50	
674	10	14	3.75	2	7.50	
675	10	14	3.75	2	7.50	
676	10	14	3.75	2	7.50	
677	10	14	3.75	2	7.50	
678	10	14	3.75	2	7.50	
679	10	14	3.75	2	7.50	
680	10	14	3.75	2	7.50	
681	10	14	3.75	2	7.50	
682	10	14	3.75	2	7.50	
683	10	14	3.75	2	7.50	
684	10	14	3.75	2	7.50	
685	10	14	3.75	2	7.50	
686	10	14	3.75	2	7.50	
687	10	14	3.75	2	7.50	
688	10	14	3.75	2	7.50	
689	10	14	3.75	2	7.50	
690	10	14	3.75	2	7.50	
691	10	14	3.75	2	7.50	
692	10	14	3.75	2	7.50	
693	10	14	3.75	2	7.50	
694	10	14	3.75	2	7.50	
695	10	14	3.75	2	7.50	
696	10	14	3.75	2	7.50	
697	10	14	3.75	2	7.50	
698	10	14	3.75	2	7.50	
699	10	14	3.75	2	7.50	
700	10	14	3.75	2	7.50	
701	10	14	3.75	2	7.50	
702	10	14	3.75	2	7.50	
703	10	14	3.75	2	7.50	
704	10	14	3.75	2	7.50	
705	10	14	3.75	2	7.50	
706	10	14	3.75	2	7.50	
707	10	14	3.75	2	7.50	
708	10	14	3.75	2	7.50	
709	10	14	3.75	2	7.50	
710	10	14	3.75	2	7.50	
711	10	14	3.75	2	7.50	
712	10	14	3.75	2	7.50	
713	10	14	3.75	2	7.50	
714	10	14	3.75	2	7.50	
715	10	14	3.75	2	7.50	
716	10	14	3.75	2	7.50	
717	10	14	3.75	2	7.50	
718	10	14	3.75	2	7.50	
719	10	14	3.75	2	7.50	
720	10	14	3.75	2	7.50	
721	10	14	3.75	2	7.50	
722	10	14	3.75	2	7.50	
723	10	14	3.75	2	7.50	
724	10	14	3.75	2	7.50	
725	10	14	3.75	2	7.50	
726	10	14	3.75	2	7.50	
727	10	14	3.75	2	7.50	
728	10	14	3.75	2	7.50	
729	10	14	3.75	2	7.50	
730	10	14	3.75	2	7.50	
731	10	14	3.75	2	7.50	
732	10	14	3.75	2	7.50	
733	10	14	3.75	2	7.50	
734	10	14	3.75	2	7.50	
735	10	14	3.75	2	7.50	
736	10	14	3.75	2	7.50	
737	10	14	3.75	2	7.50	

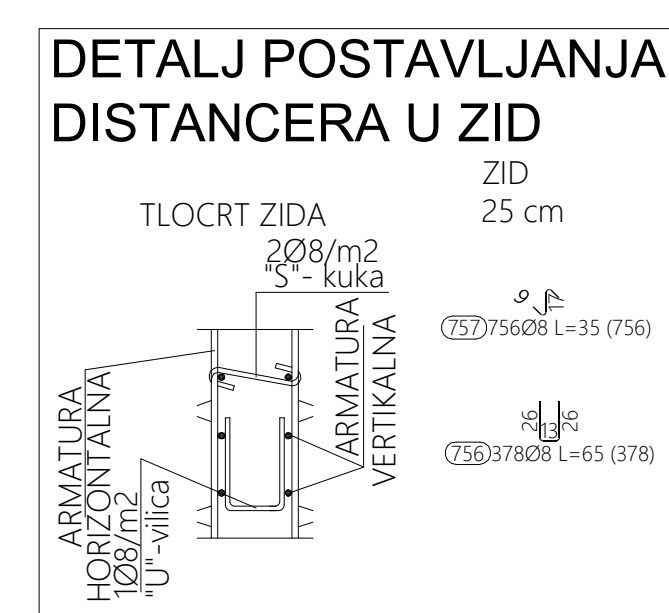

NAPOMENA
Šipke prilagoditi i po potrebi rezati na licu mjesta. Preklop 50Ø.

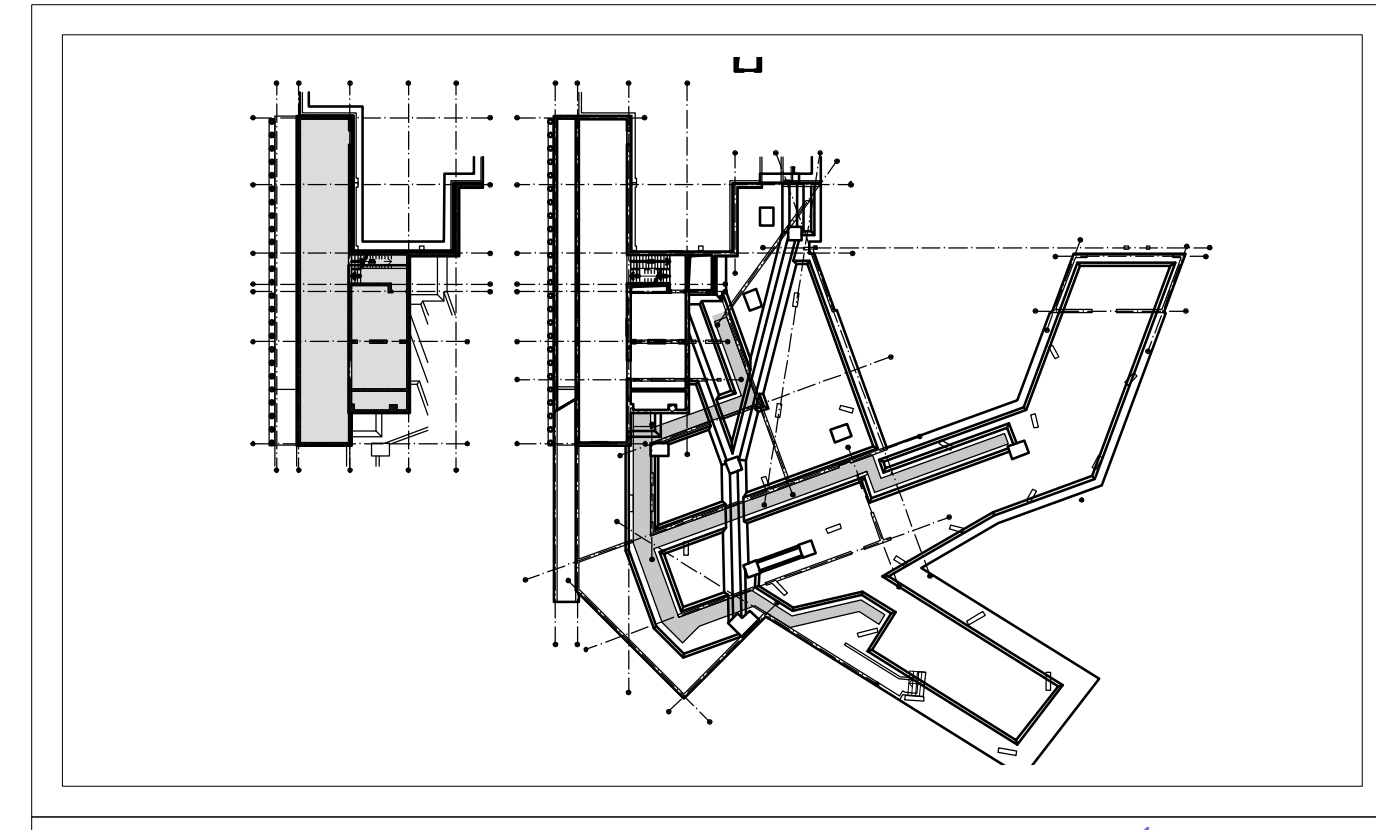

NAPOMENA
Sve dimenzije provjeriti prema važećim planovima optate.

Klasa betona	C 30/37	
Armatura	B 500 B	
Zaštitni sloj betona	Pripadajući sloj armature	
dolje	gore	bočno
4,0 cm	4,0 cm	4,0 cm
Pripadajući armaturni nacrti		
ARM_E-2_311		





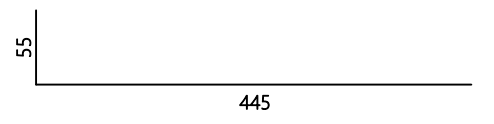
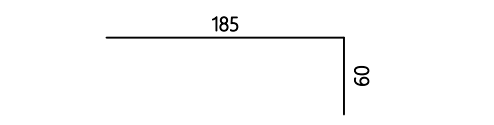
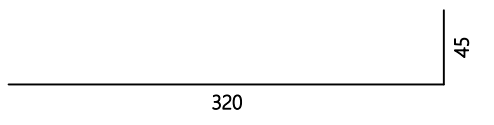
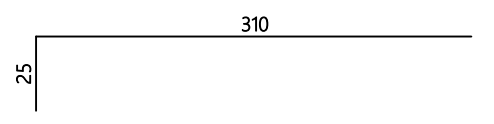
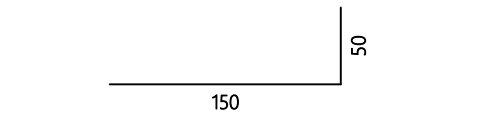
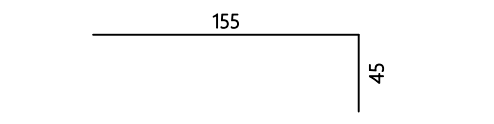
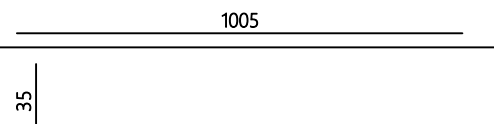
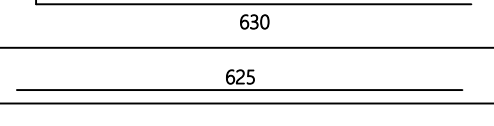
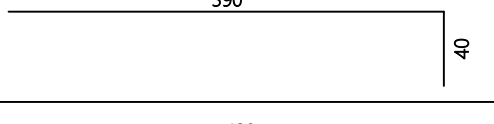
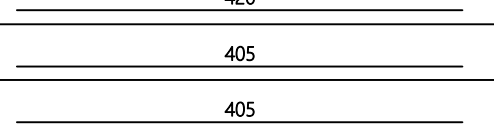
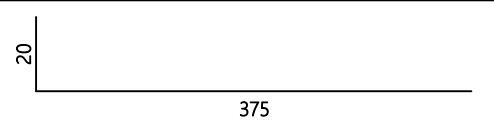

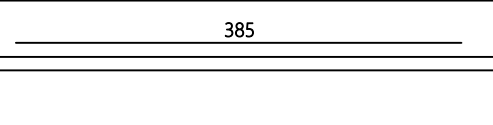
KONSTRUKTA		PEČAT I POTPISE	
KONSTRUKTA d.o.o. za projektiranje i nadzor Desetinička 25, ZAGREB, HRV. 10000 ZIR: PRIVREDNA BANKA 2340009-110164468 TEL: 011 43 43 828; FAX: 011 43 43 829 MAIL: info@konstrukt.hr		 Antonio Maglov, dipl. ing. grad. ARM_E-2_311	
INVESTITOR	TERME TUNJEVIĆ d.o.o. Ljudevitova Gata 4, Tunjevićevo 13800, 45215 Tunjevići	GL. PROJEKTANT	Tonišlav Vrdolj, dipl. ing. arh.
GRAĐEVINA	REKONSTRUKCIJA TERMALENOG REKREACIJSKOG CENTRA TERME TUNJEVIĆ	PROJEKT. UZV. PR.	Antonio Maglov, dipl. ing. grad.
LOKACIJA	na k.č. br. 3199/1, k.o. Orešjevac	IZRADIO:	Antonio Maglov, dipl. ing. grad.
FAZA	IZVEDBENI PROJEKT - ARMATURNI NACRTI	DATUM:	Novak 2023.
SKLAD:	ELEMENT - DILATACIJA 3 ARMATURA ZIDOVA	MJERILO:	1:50 REVIZIJA: 00
		NACRT BR.:	ARM - E-2 - 311

ISKAZ ARMATURE		
GRAĐEVINA:	REKONSTRUKCIJA TERMALNOG REKREACIJSKOG CENTRA TERME TUHELJ	
ISKAZ UZ NACRT:	ARM_E-2_311_0	
SADRŽAJ:	ARMATURA ZIDOVA E-2	
DATUM:	lipanj, 2023.	1/15

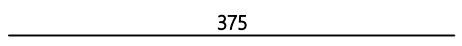
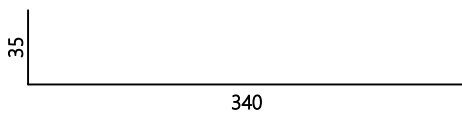
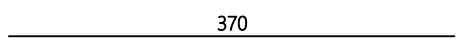
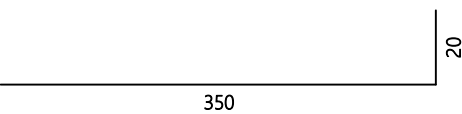
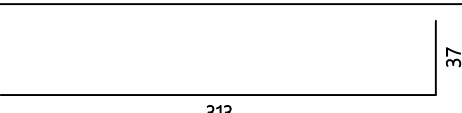
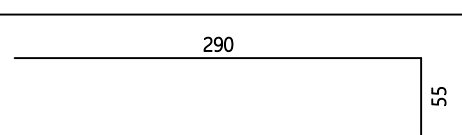

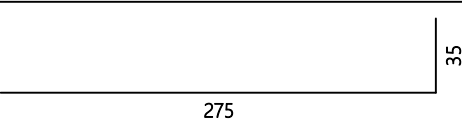
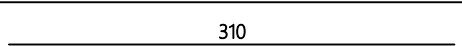
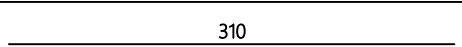
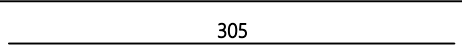
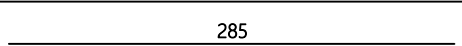
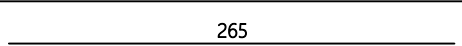
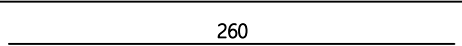
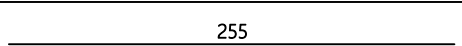

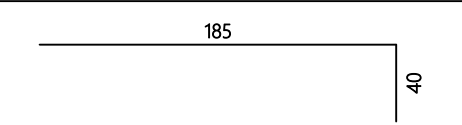
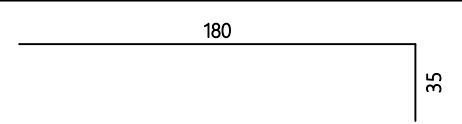
Šipke - specifikacija						
ozn	oblik i mjere [cm]	Ø	lg [m]	n [kom]	lgn [m]	Napomena
Armatura zidova E-2 (1 kom)						
601		20	5.00	4	20.00	
602		20	2.45	8	19.60	
603		16	3.65	4	14.60	
604		16	3.35	4	13.40	
605		16	2.00	8	16.00	
606		16	2.00	8	16.00	
607		14	10.05	4	40.20	
608		14	6.65	4	26.60	
609		14	6.25	4	25.00	
610		14	4.30	16	68.80	
611		14	4.20	8	33.60	
612		14	4.05	44	178.20	
613		14	4.05	4	16.20	
614		14	3.95	4	15.80	
615		14	3.90	2	7.80	
616		14	3.85	4	15.40	

ISKAZ ARMATURE		
GRAĐEVINA:	REKONSTRUKCIJA TERMALNOG REKREACIJSKOG CENTRA TERME TUHELJ	
ISKAZ UZ NACRT:	ARM_E-2_311_0	
SADRŽAJ:	ARMATURA ZIDOVA E-2	
DATUM:	lipanj, 2023.	2/15

Šipke - specifikacija						
ozn	oblik i mjere [cm]	Ø	lg [m]	n [kom]	lgn [m]	Napomena
617		14	3.75	56	210.00	
618		14	3.75	2	7.50	
619		14	3.70	4	14.80	
620		14	3.70	2	7.40	
621		14	3.50	4	14.00	
622		14	3.45	2	6.90	
623		14	3.25	4	13.00	
624		14	3.10	2	6.20	
625		14	3.10	12	37.20	
626		14	3.10	4	12.40	
627		14	3.05	10	30.50	
628		14	2.85	4	11.40	
629		14	2.65	6	15.90	
630		14	2.60	4	10.40	
631		14	2.55	2	5.10	
632		14	2.40	2	4.80	
633		14	2.25	4	9.00	
634		14	2.15	2	4.30	

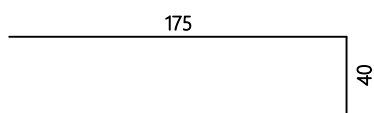
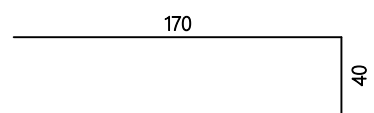
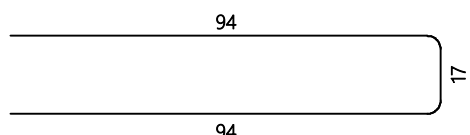
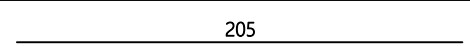
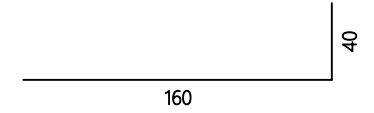

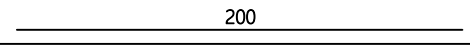
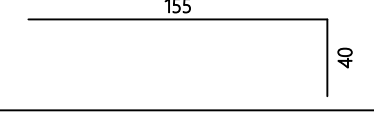
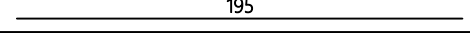
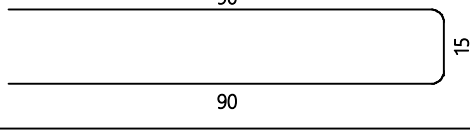
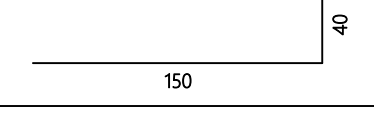
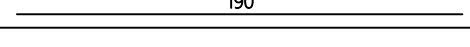
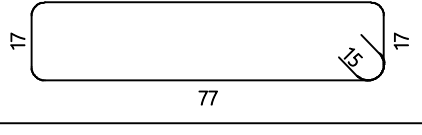
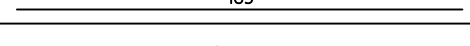
ISKAZ ARMATURE

GRAĐEVINA:	REKONSTRUKCIJA TERMALNOG REKREACIJSKOG CENTRA TERME TUHELJ	
ISKAZ UZ NACRT:	ARM_E-2_311_0	
SADRŽAJ:	ARMATURA ZIDOVA E-2	
DATUM:	lipanj, 2023.	3/15

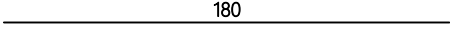
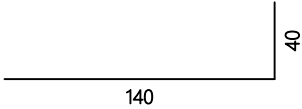
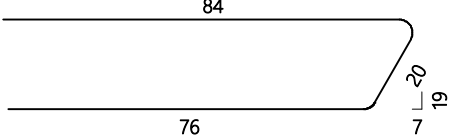
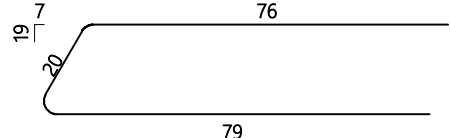
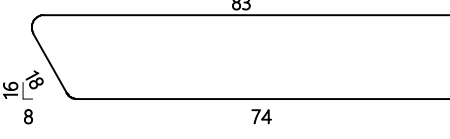
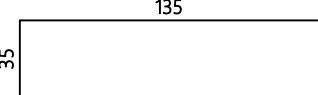
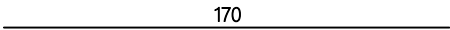
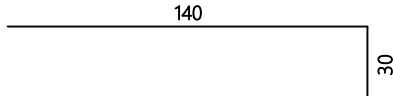
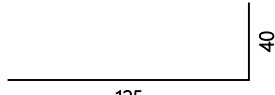
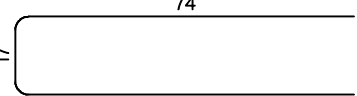
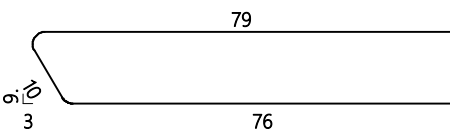

Šipke - specifikacija						
ozn	oblik i mjere [cm]	Ø	lg [m]	n [kom]	lgn [m]	Napomena
635		14	2.15	12	25.80	
636		14	2.10	4	8.40	
637		14	2.05	8	16.40	
638		14	2.05	2	4.10	
639		14	2.00	8	16.00	
640		14	2.00	2	4.00	
641		14	2.00	4	8.00	
642		14	1.95	12	23.40	
643		14	1.95	4	7.80	
644		14	1.95	40	78.00	
645		14	1.90	4	7.60	
646		14	1.90	4	7.60	
647		14	2.18	7	15.26	
648		14	1.85	4	7.40	
649		14	1.85	4	7.40	

ISKAZ ARMATURE

GRAĐEVINA:	REKONSTRUKCIJA TERMALNOG REKREACIJSKOG CENTRA TERME TUHELJ		
ISKAZ UZ NACRT:	ARM_E-2_311_0		
SADRŽAJ:	ARMATURA ZIDOVA E-2		
DATUM:	lipanj, 2023.	4/15	

Šipke - specifikacija						
ozn	oblik i mjere [cm]	Ø	lg [m]	n [kom]	lgn [m]	Napomena
650		14	1.80	16	28.80	
651		14	1.80	4	7.20	
652		14	1.80	2	3.60	
653		14	1.75	2	3.50	
654		14	1.75	1	1.75	
655		14	1.70	4	6.80	
656		14	1.70	18	30.60	
657		14	1.70	2	3.40	
658		14	1.65	6	9.90	
659		14	1.65	6	9.90	
660		14	1.65	2	3.30	
661		14	1.60	2	3.20	

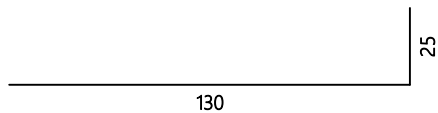
ISKAZ ARMATURE	
GRAĐEVINA:	REKONSTRUKCIJA TERMALNOG REKREACIJSKOG CENTRA TERME TUHELJ
ISKAZ UZ NACRT:	ARM_E-2_311_0
SADRŽAJ:	ARMATURA ZIDOVA E-2
DATUM:	lipanj, 2023. 5/15

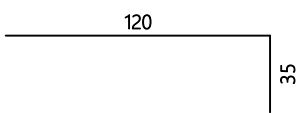
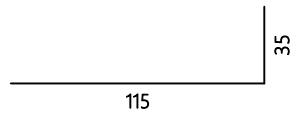
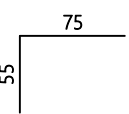
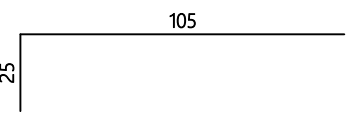
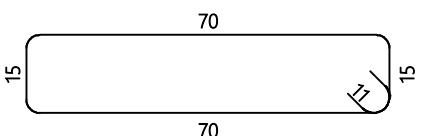
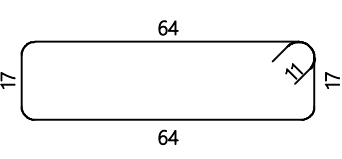
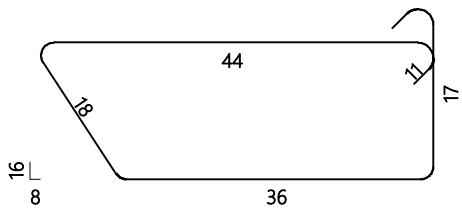
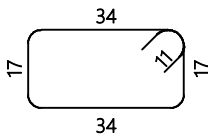
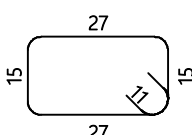
Šipke - specifikacija						
ozn	oblik i mjere [cm]	Ø	lg [m]	n [kom]	lgn [m]	Napomena
662		14	1.55	2	3.10	
663		14	1.55	6	9.30	
664		14	1.55	6	9.30	
665		14	1.50	6	9.00	
666		14	1.30	4	5.20	
667		14	1.30	2	2.60	
668		10	1.92	23	44.16	
669		10	1.84	3	5.52	
670		10	1.37	2	2.74	
671		10	1.24	2	2.48	
672		10	1.06	2	2.12	

ISKAZ ARMATURE

GRAĐEVINA:	REKONSTRUKCIJA TERMALNOG REKREACIJSKOG CENTRA TERME TUHELJ	
ISKAZ UZ NACRT:	ARM_E-2_311_0	
SADRŽAJ:	ARMATURA ZIDOVA E-2	
DATUM:	lipanj, 2023.	6/15

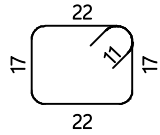
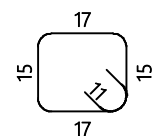
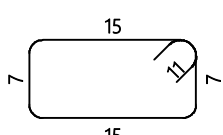
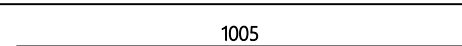
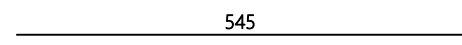
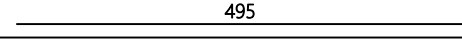
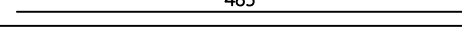
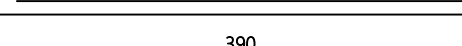
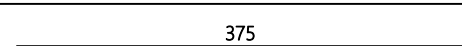
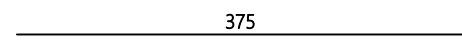
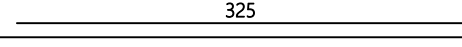
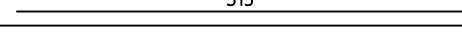
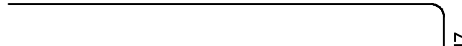
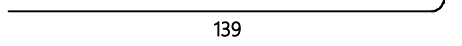
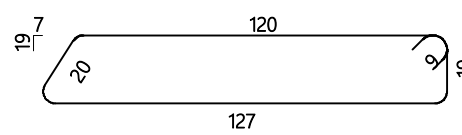
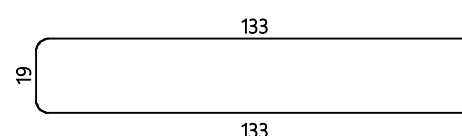
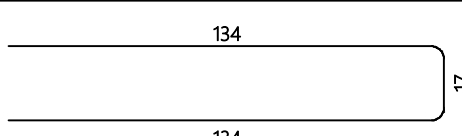
Šipke - specifikacija						
ozn	oblik i mjere [cm]	Ø	lg [m]	n [kom]	lgn [m]	Napomena
673		10	1.00	3	3.00	
674		10	0.86	4	3.44	
675		10	0.66	5	3.30	
676		8	10.05	6	60.30	
677		8	5.45	6	32.70	
678		8	4.95	106	524.70	
679		8	4.85	26	126.10	
680		8	4.05	40	162.00	
681		8	3.90	34	132.60	
682		8	3.75	18	67.50	
683		8	3.75	162	607.50	
684		8	3.25	20	65.00	
685		8	3.15	20	63.00	
686		8	2.95	17	50.15	
687		8	3.04	21	63.84	
688		8	2.85	1	2.85	
689		8	2.85	25	71.25	

ISKAZ ARMATURE

GRAĐEVINA:	REKONSTRUKCIJA TERMALNOG REKREACIJSKOG CENTRA TERME TUHELJ	
ISKAZ UZ NACRT:	ARM_E-2_311_0	
SADRŽAJ:	ARMATURA ZIDOVA E-2	
DATUM:	lipanj, 2023.	7/15

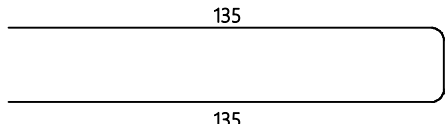
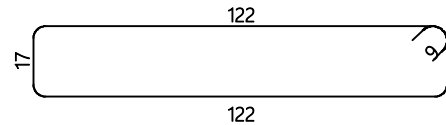
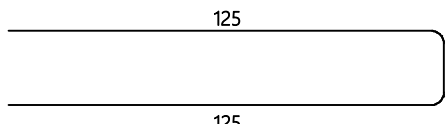
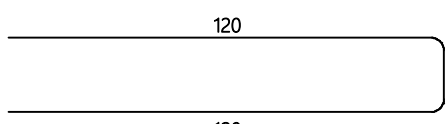
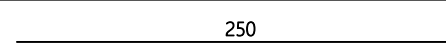
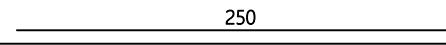
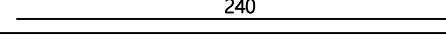
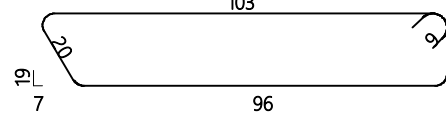
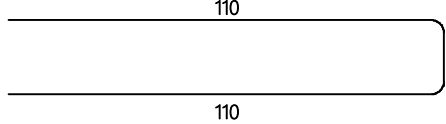
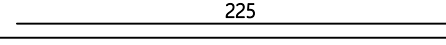
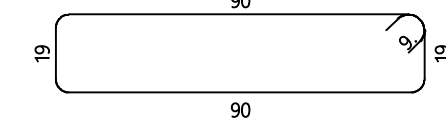
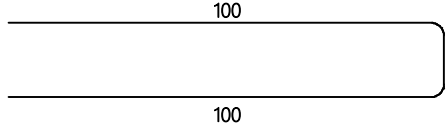
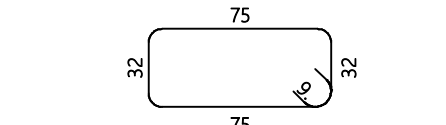
Šipke - specifikacija						
ozn	oblik i mjere [cm]	Ø	lg [m]	n [kom]	lgn [m]	Napomena
690		8	2.85	8	22.80	
691		8	2.96	16	47.36	
692		8	2.65	8	21.20	
693		8	2.55	14	35.70	
694		8	2.50	10	25.00	
695		8	2.50	20	50.00	
696		8	2.40	6	14.40	
697		8	2.56	21	53.76	
698		8	2.35	26	61.10	
699		8	2.25	32	72.00	
700		8	2.36	1	2.36	
701		8	2.15	32	68.80	
702		8	2.32	34	78.88	

ISKAZ ARMATURE

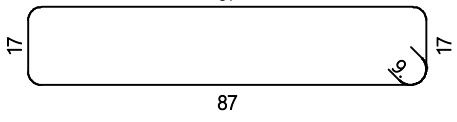
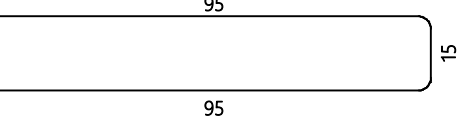
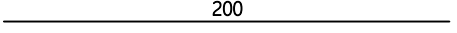
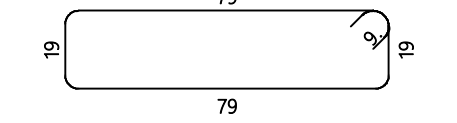
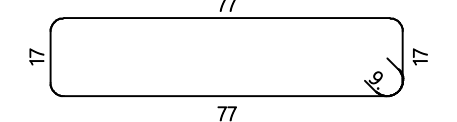
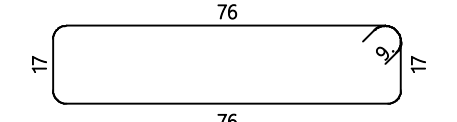
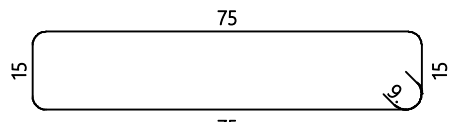
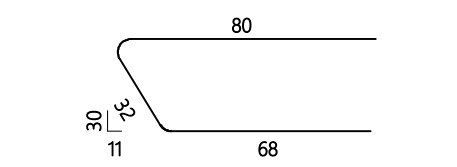
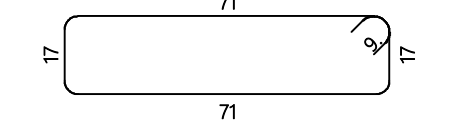
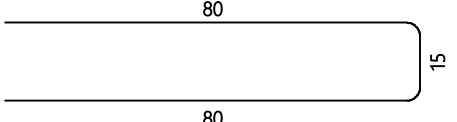
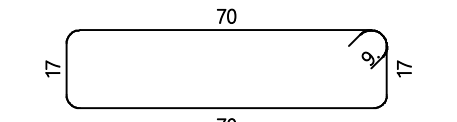

GRAĐEVINA:	REKONSTRUKCIJA TERMALNOG REKREACIJSKOG CENTRA TERME TUHELJ	
ISKAZ UZ NACRT:	ARM_E-2_311_0	
SADRŽAJ:	ARMATURA ZIDOVA E-2	
DATUM:	lipanj, 2023.	8/15

Šipke - specifikacija

ozn	oblik i mjere [cm]	Ø	lg [m]	n [kom]	lgn [m]	Napomena
703		8	2.26	25	56.50	
704		8	2.05	2	4.10	
705		8	2.00	7	14.00	
706		8	2.14	2	4.28	
707		8	2.06	108	222.48	
708		8	2.04	3	6.12	
709		8	1.98	19	37.62	
710		8	1.80	6	10.80	
711		8	1.94	3	5.82	
712		8	1.75	14	24.50	
713		8	1.92	2	3.84	

ISKAZ ARMATURE

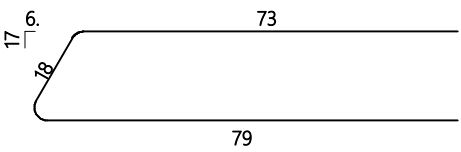
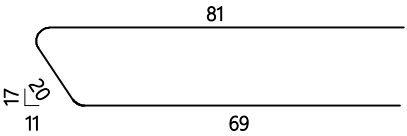
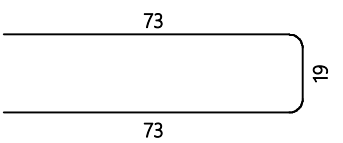
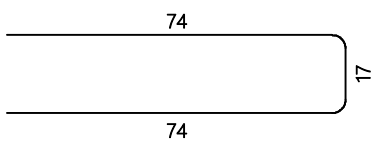
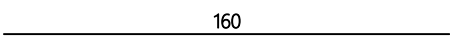
GRAĐEVINA:	REKONSTRUKCIJA TERMALNOG REKREACIJSKOG CENTRA TERME TUHELJ	
ISKAZ UZ NACRT:	ARM_E-2_311_0	
SADRŽAJ:	ARMATURA ZIDOVA E-2	
DATUM:	lipanj, 2023.	9/15

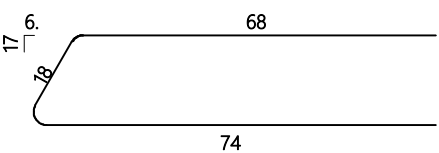
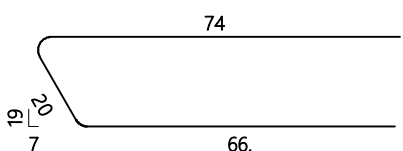
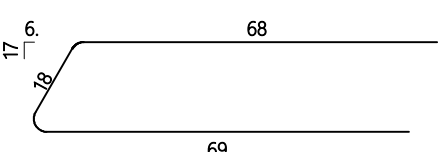
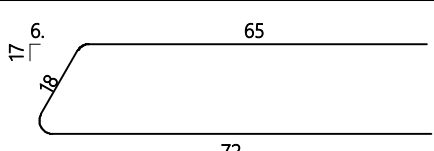
Šipke - specifikacija						
ozn	oblik i mjere [cm]	Ø	lg [m]	n [kom]	lgn [m]	Napomena
714		8	1.70	24	40.80	
715		8	1.70	20	34.00	
716		8	1.65	2	3.30	
717		8	1.65	2	3.30	
718		8	1.60	4	6.40	
719		8	1.60	21	33.60	
720		8	1.60	17	27.20	
721		8	1.60	24	38.40	
722		8	1.55	25	38.75	
723		8	1.55	27	41.85	

ISKAZ ARMATURE

GRAĐEVINA:	REKONSTRUKCIJA TERMALNOG REKREACIJSKOG CENTRA TERME TUHELJ	
ISKAZ UZ NACRT:	ARM_E-2_311_0	
SADRŽAJ:	ARMATURA ZIDOVA E-2	
DATUM:	lipanj, 2023.	10/15

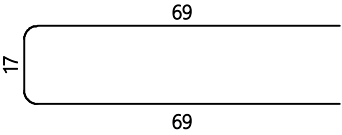
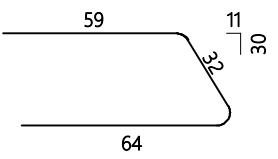
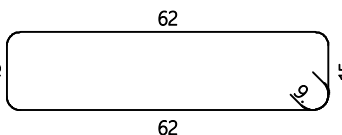
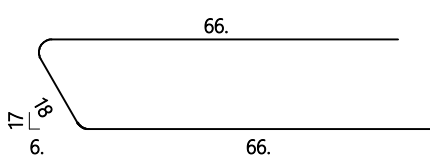
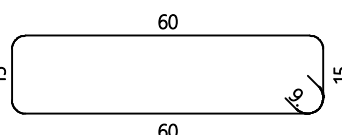
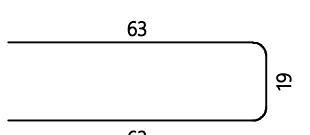
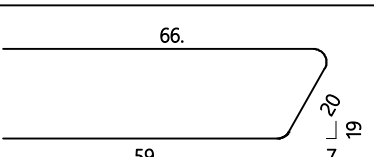
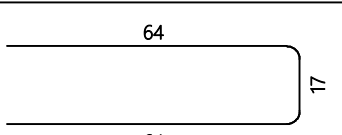
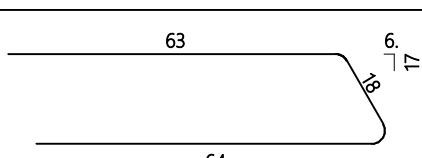
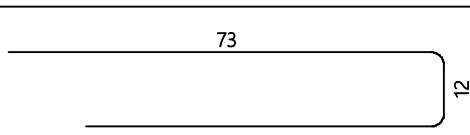
Šipke - specifikacija						
ozn	oblik i mjere [cm]	Ø	lg [m]	n [kom]	lgn [m]	Napomena
724		8	1.55	6	9.30	
725		8	1.55	6	9.30	
726		8	1.72	3	5.16	
727		8	1.50	25	37.50	
728		8	1.68	5	8.40	
729		8	1.45	42	60.90	
730		8	1.45	25	36.25	
731		8	1.45	369	535.05	
732		8	1.45	21	30.45	
733		8	1.45	34	49.30	

ISKAZ ARMATURE

GRAĐEVINA:	REKONSTRUKCIJA TERMALNOG REKREACIJSKOG CENTRA TERME TUHELJ	
ISKAZ UZ NACRT:	ARM_E-2_311_0	
SADRŽAJ:	ARMATURA ZIDOVA E-2	
DATUM:	lipanj, 2023.	11/15

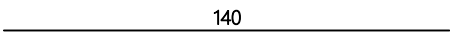
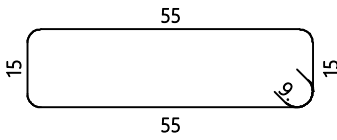
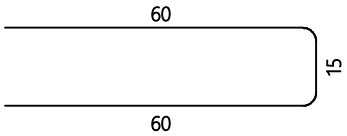
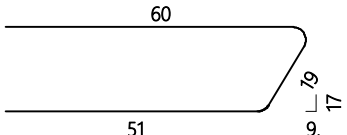
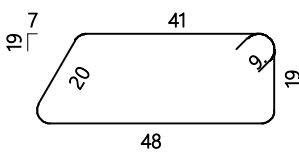
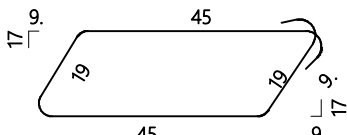
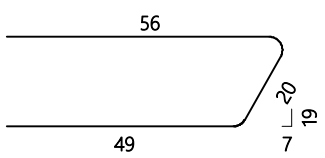
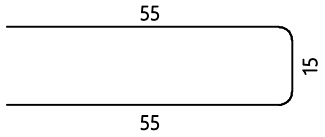
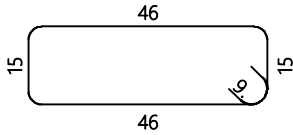
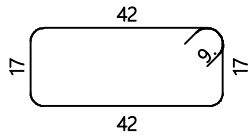
Šipke - specifikacija						
ozn	oblik i mjere [cm]	Ø	lg [m]	n [kom]	lgn [m]	Napomena
734		8	1.40	7	9.80	
735		8	1.58	3	4.74	
736		8	1.35	371	500.85	
737		8	1.30	8	10.40	
738		8	1.46	2	2.92	
739		8	1.46	4	5.84	
740		8	1.25	3	3.75	
741		8	1.25	5	6.25	
742		8	1.40	18	25.20	
743		8	1.36	4	5.44	

ISKAZ ARMATURE

GRAĐEVINA:	REKONSTRUKCIJA TERMALNOG REKREACIJSKOG CENTRA TERME TUHELJ	
ISKAZ UZ NACRT:	ARM_E-2_311_0	
SADRŽAJ:	ARMATURA ZIDOVA E-2	
DATUM:	lipanj, 2023.	12/15

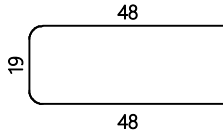
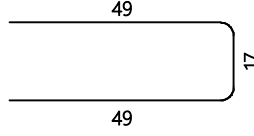
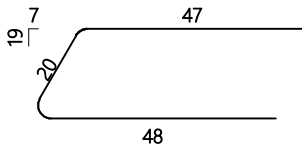
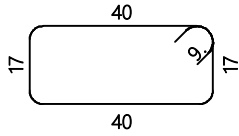
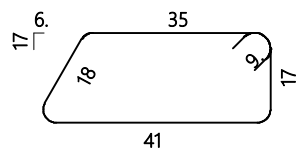
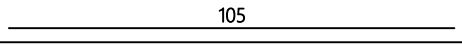
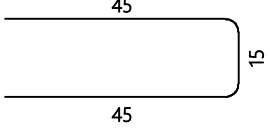
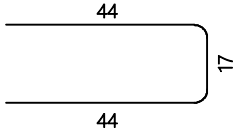
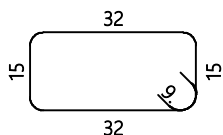
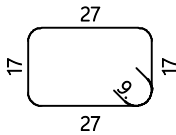
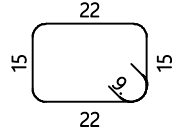
Šipke - specifikacija						
ozn	oblik i mjere [cm]	∅	lg [m]	n [kom]	lgn [m]	Napomena
744		8	1.15	4	4.60	
745		8	1.15	9	10.35	
746		8	1.15	3	3.45	
747		8	1.32	3	3.96	
748		8	1.29	2	2.58	
749		8	1.05	54	56.70	
750		8	1.05	123	129.15	
751		8	1.05	86	90.30	
752		8	1.12	2	2.24	
753		8	1.06	6	6.36	
754		8	0.92	2	1.84	

ISKAZ ARMATURE

GRAĐEVINA:	REKONSTRUKCIJA TERMALNOG REKREACIJSKOG CENTRA TERME TUHELJ	
ISKAZ UZ NACRT:	ARM_E-2_311_0	
SADRŽAJ:	ARMATURA ZIDOVA E-2	
DATUM:	lipanj, 2023.	13/15

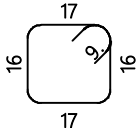
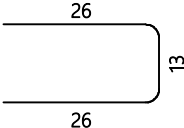
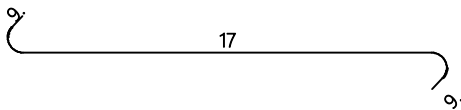
Šipke - specifikacija						
ozn	oblik i mjere [cm]	Ø	lg [m]	n [kom]	lgn [m]	Napomena
755		8	0.84	4	3.36	
756		8	0.65	378	245.70	
757		8	0.35	756	264.60	

ISKAZ ARMATURE		
GRAĐEVINA:	REKONSTRUKCIJA TERMALNOG REKREACIJSKOG CENTRA TERME TUHELJ	
ISKAZ UZ NACRT:	ARM_E-2_311_0	
SADRŽAJ:	ARMATURA ZIDOVA E-2	
DATUM:	lipanj, 2023.	14/15

Šipke - rekapitulacija			
Ø [mm]	lgn [m]	Jedinična težina [kg/m']	Težina [kg]
B500B			
8	5422.50	0.40	2141.89
10	66.76	0.62	41.19
14	1236.01	1.21	1495.57
16	60.00	1.58	94.80
20	39.60	2.47	97.81
Ukupno (B500B)			3871.26
Ukupno			3871.26

ISKAZ ARMATURE		
GRAĐEVINA:	REKONSTRUKCIJA TERMALNOG REKREACIJSKOG CENTRA TERME TUHELJ	
ISKAZ UZ NACRT:	ARM_E-2_311_0	
SADRŽAJ:	ARMATURA ZIDOVA E-2	
DATUM:	lipanj, 2023.	15/15

Mreže - specifikacija							
Pozicija	Oznaka mreže	B [cm]	L [cm]	n	Jedinična težina [kg/m ²]	Ukupna težina [kg]	Napomena
Armatura zidova E-2 (1 kom)							
1-1	Q-335	215	374	2	5.38	86.52	
1-2	Q-335	131	374	2	5.38	52.91	
1-3	Q-335	215	374	2	5.38	86.52	
1-4	Q-335	213	374	2	5.38	85.65	
1-5	Q-335	215	405	26	5.38	1218.00	
1-6	Q-335	155	405	2	5.38	67.55	
1-7	Q-335	168	340	2	5.38	61.51	
1-8	Q-335	83	405	2	5.38	36.24	
1-9	Q-335	50	309	2	5.38	16.62	
1-10	Q-335	215	374	22	5.38	951.73	
1-11	Q-335	137	374	2	5.38	55.12	
1-12	Q-335	155	405	2	5.38	67.36	
1-13	Q-335	184	405	2	5.38	80.29	
1-14	Q-335	138	405	2	5.38	59.92	
1-15	Q-335	215	295	6	5.38	204.74	
1-16	Q-335	167	405	2	5.38	72.61	
1-17	Q-335	55	374	2	5.38	22.13	
1-18	Q-335	215	374	2	5.38	86.52	
1-19	Q-335	70	374	2	5.38	28.17	
Ukupno						3340.14	

NACRT SAVIJANJA ARMATURE ZIDOVA, DILATACIJA 3

ARMATURA ZIDA U OSI 3.16,
M 1:50

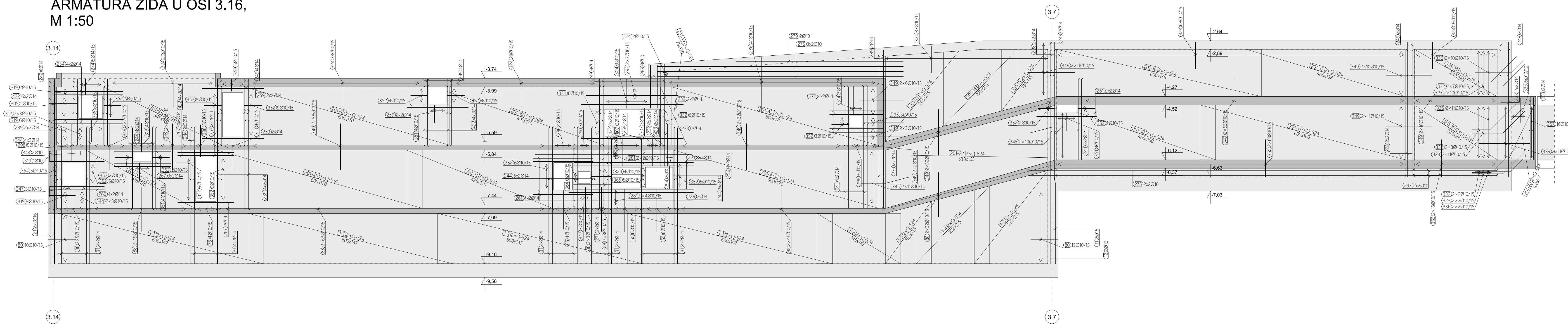

ARMATURA ZIDA U OSI 3.18,
M 1:50

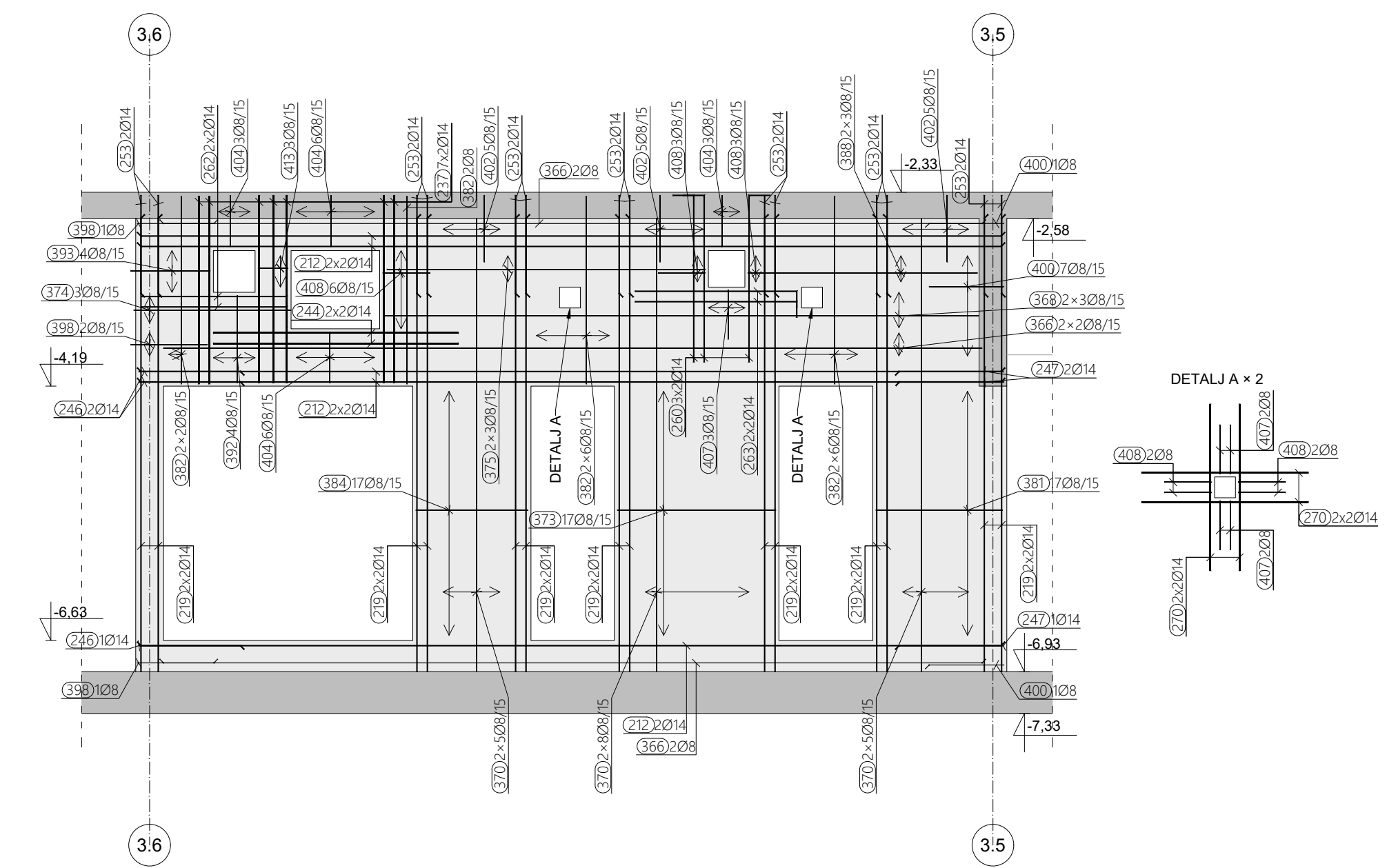

ARMATURA ZIDA U OSI 3.17,
M 1:50

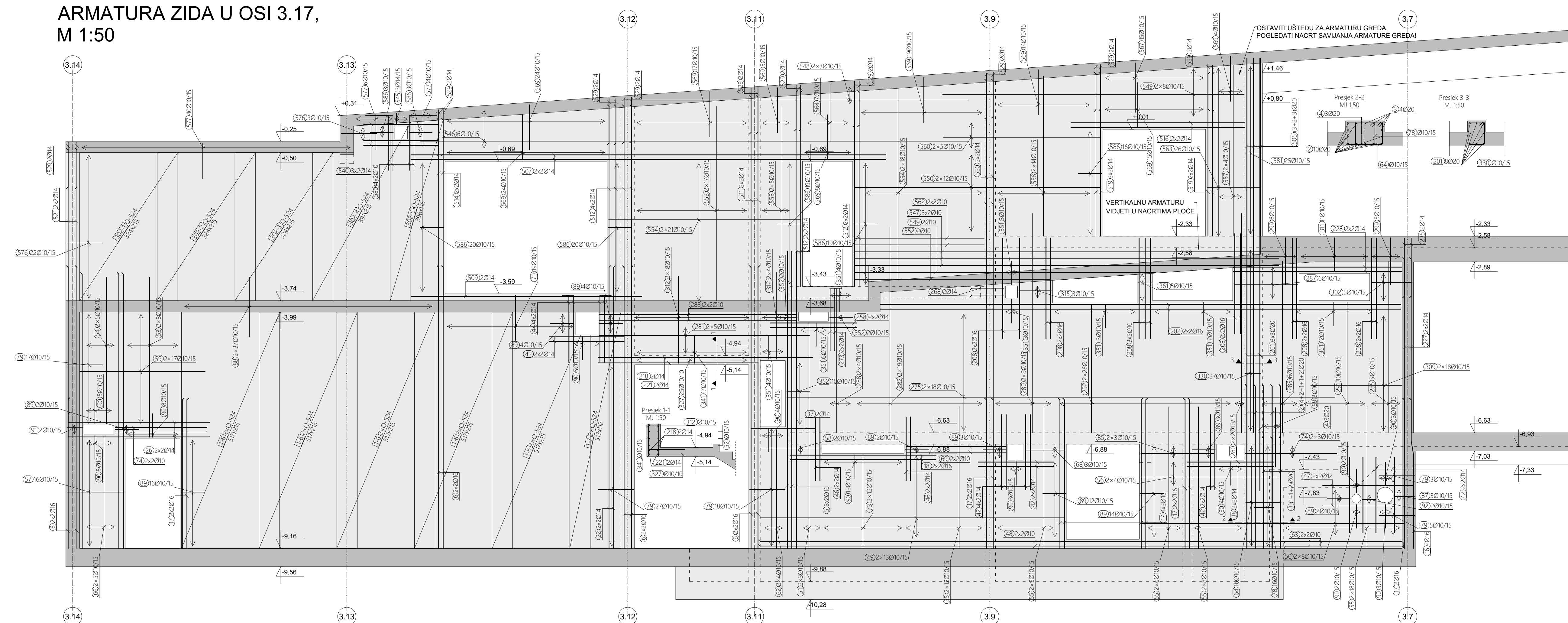

ARMATURA ZIDA U OSI 3.19,
M 1:50

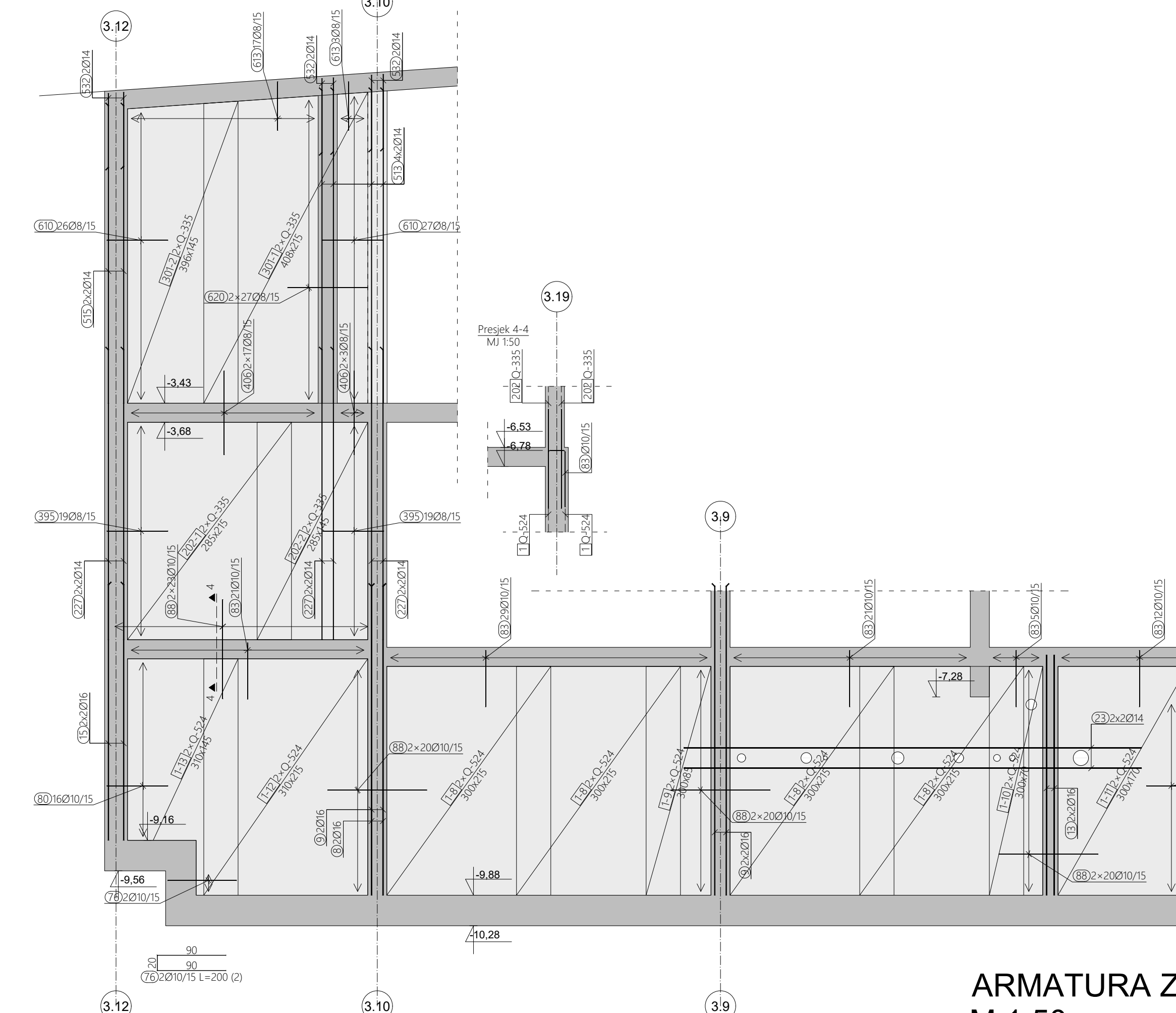

ARMATURA ZIDA U OSI 3.15,
M 1:50

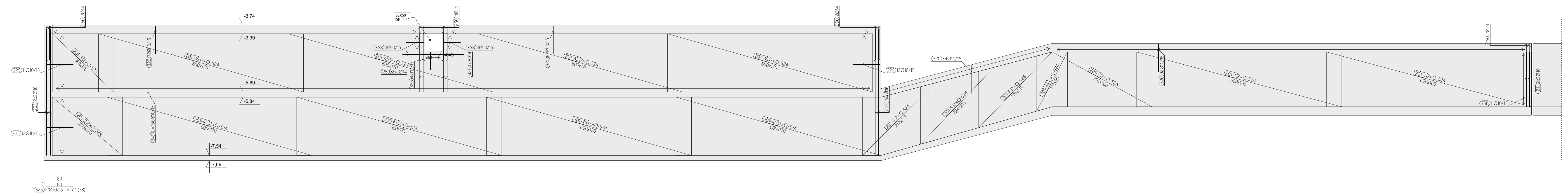

PREGLEDNI NACRT M 1:300

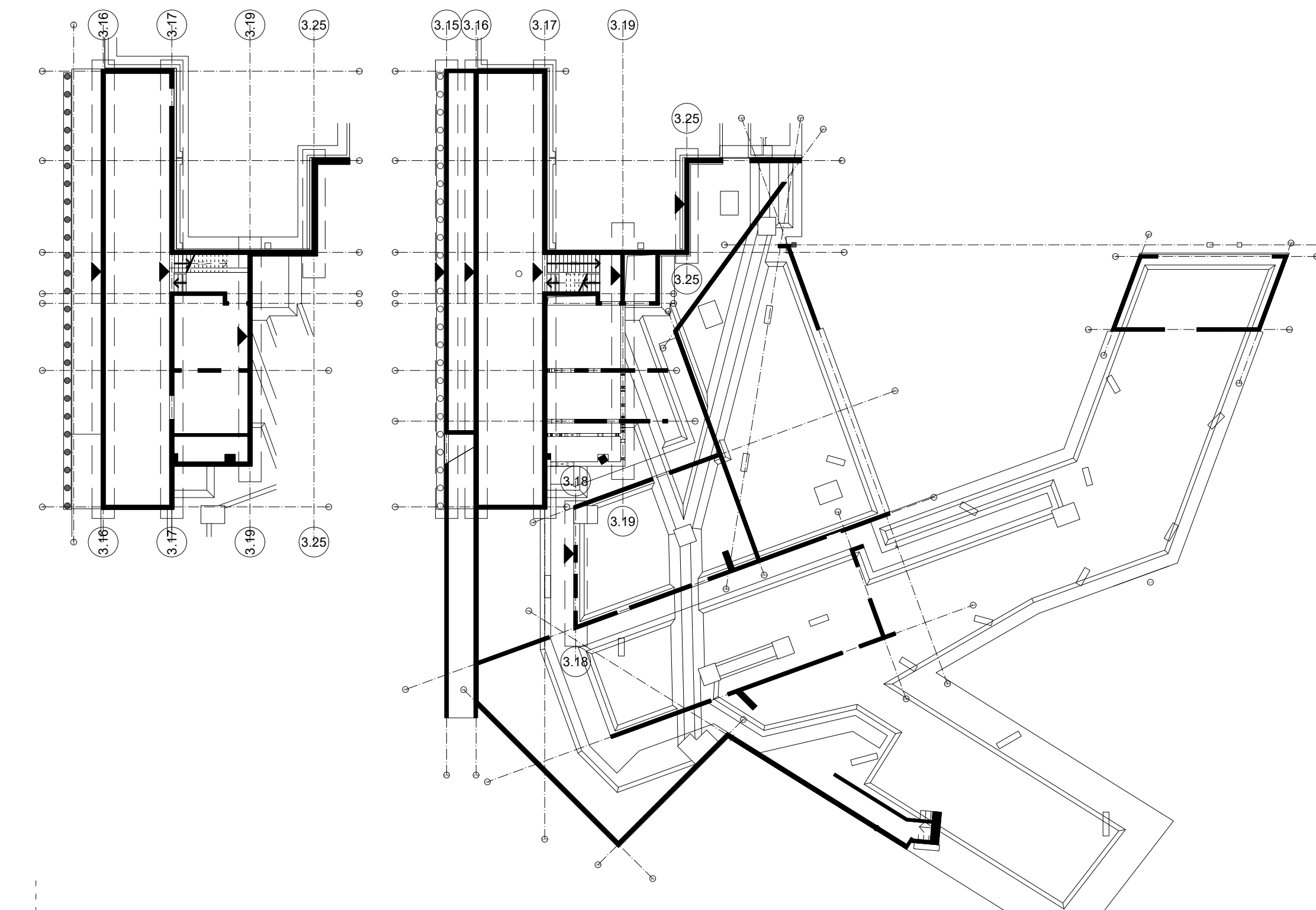

NAPOMENA
Šipke pripremiti i po potrebi rezati na licu mjesta. Preklap 50D.

NAPOMENA
Sve dimenzije provjeriti prema važećim planovima opiate.

Klasa betona	C 30/37
Armatura	B 500 B
Zaštni sloj betona	
dolje	gore
4,0 cm	4,0 cm
Pripadajući armaturni nacrti	
ARM_E-2_312	

ARMATURA ZIDA U OSI 3.25,
M 1:50

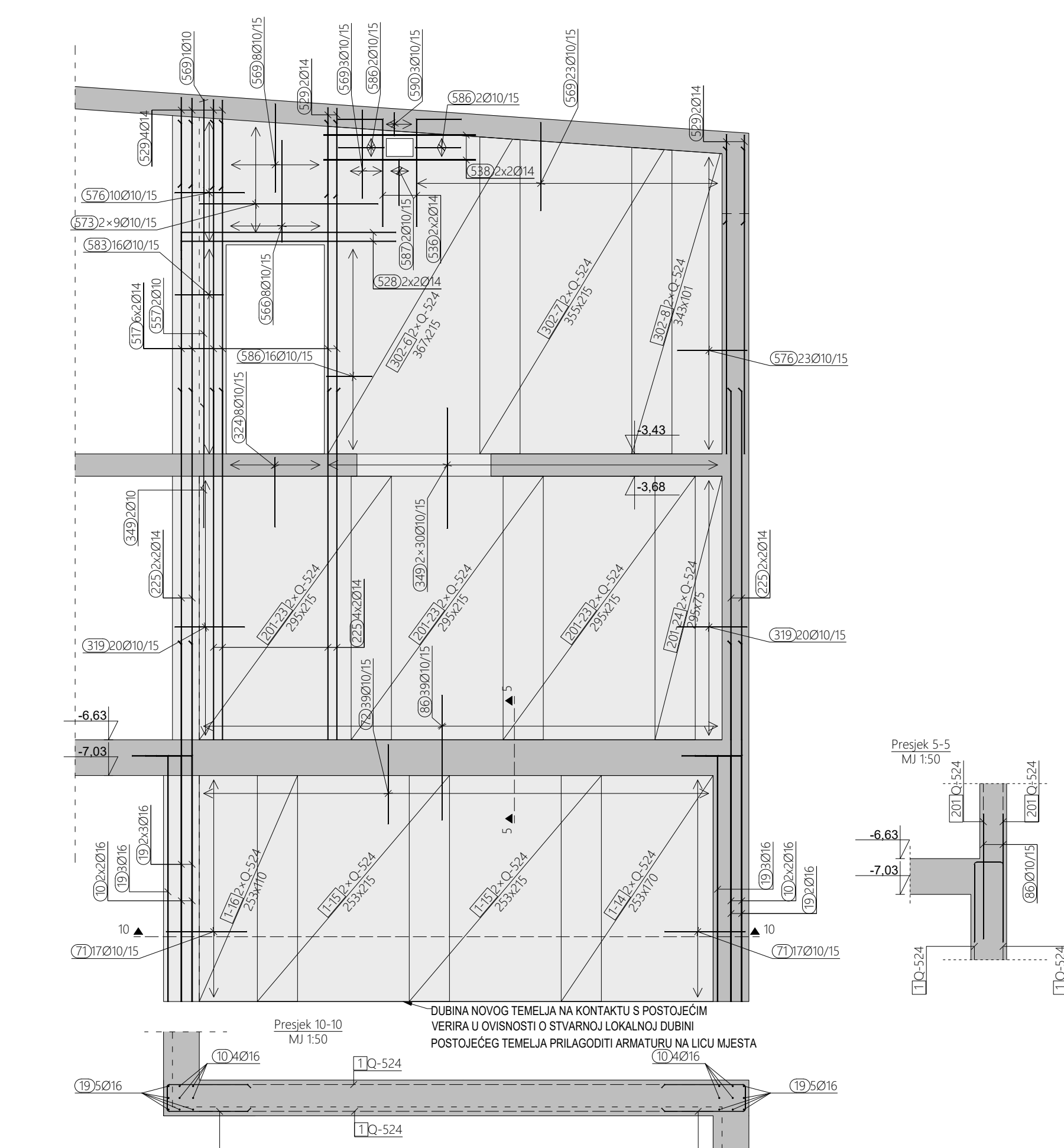

- DETALJ POSTAVLJANJA DISTANCERA U ZID E-3
TLOCRT ZIDA 200/m² kuka
ZID 20 cm
[Diagram showing reinforcement detail for wall E-3 with 20cm spacing]
- DETALJ POSTAVLJANJA DISTANCERA U ZID E-3
TLOCRT ZIDA 200/m² kuka
ZID 25 cm
[Diagram showing reinforcement detail for wall E-3 with 25cm spacing]
- DETALJ POSTAVLJANJA DISTANCERA U ZID E-3
TLOCRT ZIDA 200/m² kuka
ZID 30 cm
[Diagram showing reinforcement detail for wall E-3 with 30cm spacing]
- DETALJ POSTAVLJANJA DISTANCERA U ZID E-3
TLOCRT ZIDA 200/m² kuka
ZID 40 cm
[Diagram showing reinforcement detail for wall E-3 with 40cm spacing]
- DETALJ POSTAVLJANJA DISTANCERA U ZID E-2
TLOCRT ZIDA 200/m² kuka
ZID 20 cm
[Diagram showing reinforcement detail for wall E-2 with 20cm spacing]
- DETALJ POSTAVLJANJA DISTANCERA U ZID E-2
TLOCRT ZIDA 200/m² kuka
ZID 25 cm
[Diagram showing reinforcement detail for wall E-2 with 25cm spacing]
- DETALJ POSTAVLJANJA DISTANCERA U ZID E-2
TLOCRT ZIDA 200/m² kuka
ZID 30 cm
[Diagram showing reinforcement detail for wall E-2 with 30cm spacing]
- DETALJ POSTAVLJANJA DISTANCERA U ZID E-1
TLOCRT ZIDA 200/m² kuka
ZID 25 cm
[Diagram showing reinforcement detail for wall E-1 with 25cm spacing]
- DETALJ POSTAVLJANJA DISTANCERA U ZID E-1
TLOCRT ZIDA 200/m² kuka
ZID 30 cm
[Diagram showing reinforcement detail for wall E-1 with 30cm spacing]

KONSTRUKTA
KONSTRUKTA d.o.o. za projektiranje i nadzor
Breskova 29, ZAGREB, OIB: 664747695
ZIR: PRIVREDNA BANKA 2340009-1110164468
TEL: 0126 43 828; FAX: 0126 43 829
MAIL: info@konstrakta.hr

PEČAT I POTPIS:
[Signature and stamp of Antonio Maglov]

INVESTITOR	TERME TUNJEVA d.o.o. Ljubička Glava 4, Tunjeva Toplica, 49215 Tunjeva	GL. PROJEKTANT	Toniša Vrh, dipl. ing. arh.
GRADIVINA	NEKOPRIVREDNO TERMOIZOLIRANO NEKOPRIVREDNO CENTRA TERMA TUNJEVA	PROJEKT. IZV. PR. IZRAČIO:	Antonio Maglov, dipl. ing. grad.
LOKACIJA	na k.č.br. 3198/1, k.o. Orednjevec	DATUM:	16.06.2023.
FAZA	IZVEDBENI PROJEKT - ARMATURNI NACRTI	MASŠTO:	1:50
SKOPAJ:	ELEMENT - DILATACIJA 3 ARMATURA ZIDOVIA	REVIZIJA:	00
		NACRT BR.:	ARM - E-2 - 312

ARMATURA ZIDA U OSI 3.8b,
M 1:50

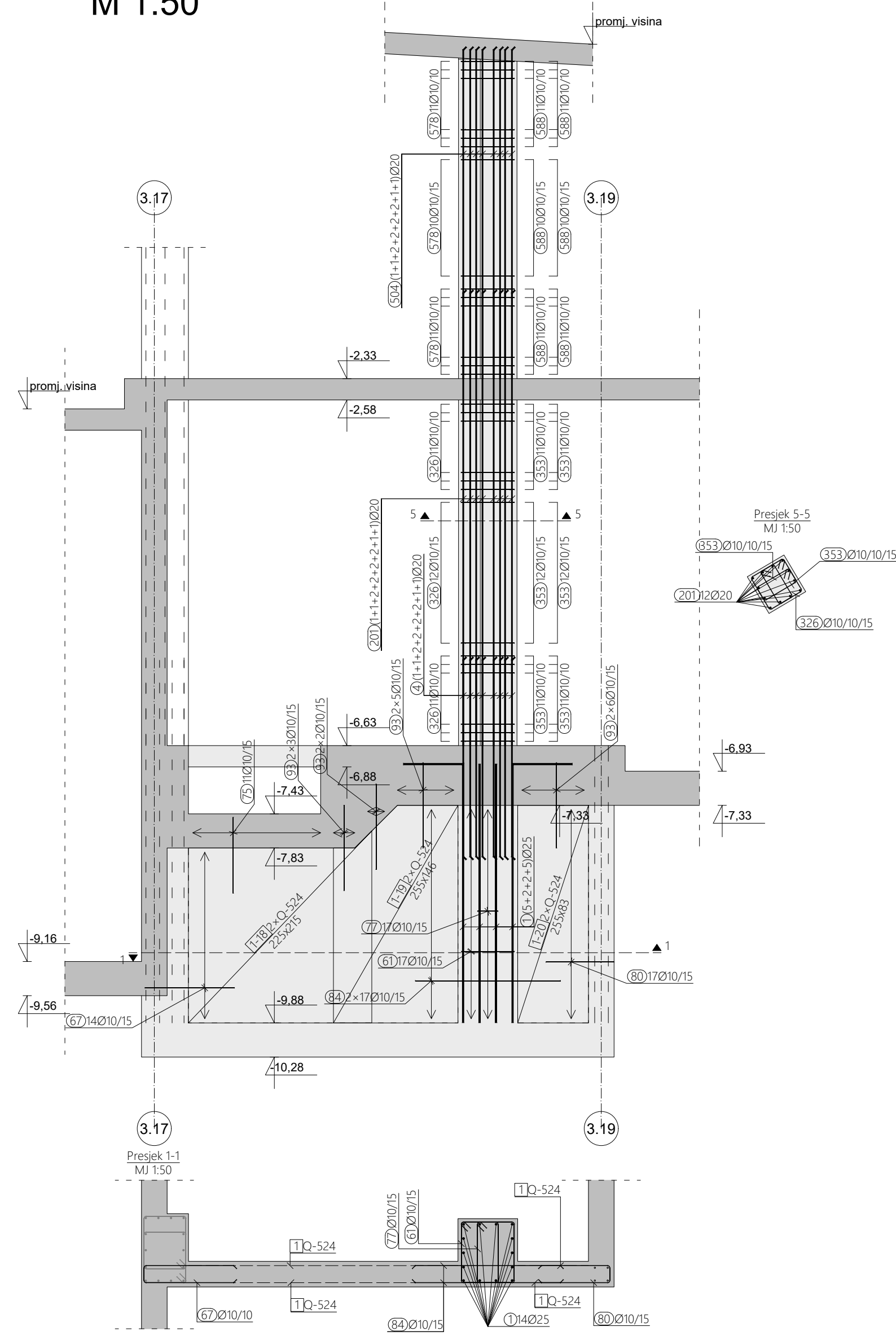

ARMATURA ZIDA U OSI 3.8a,
M 1:50

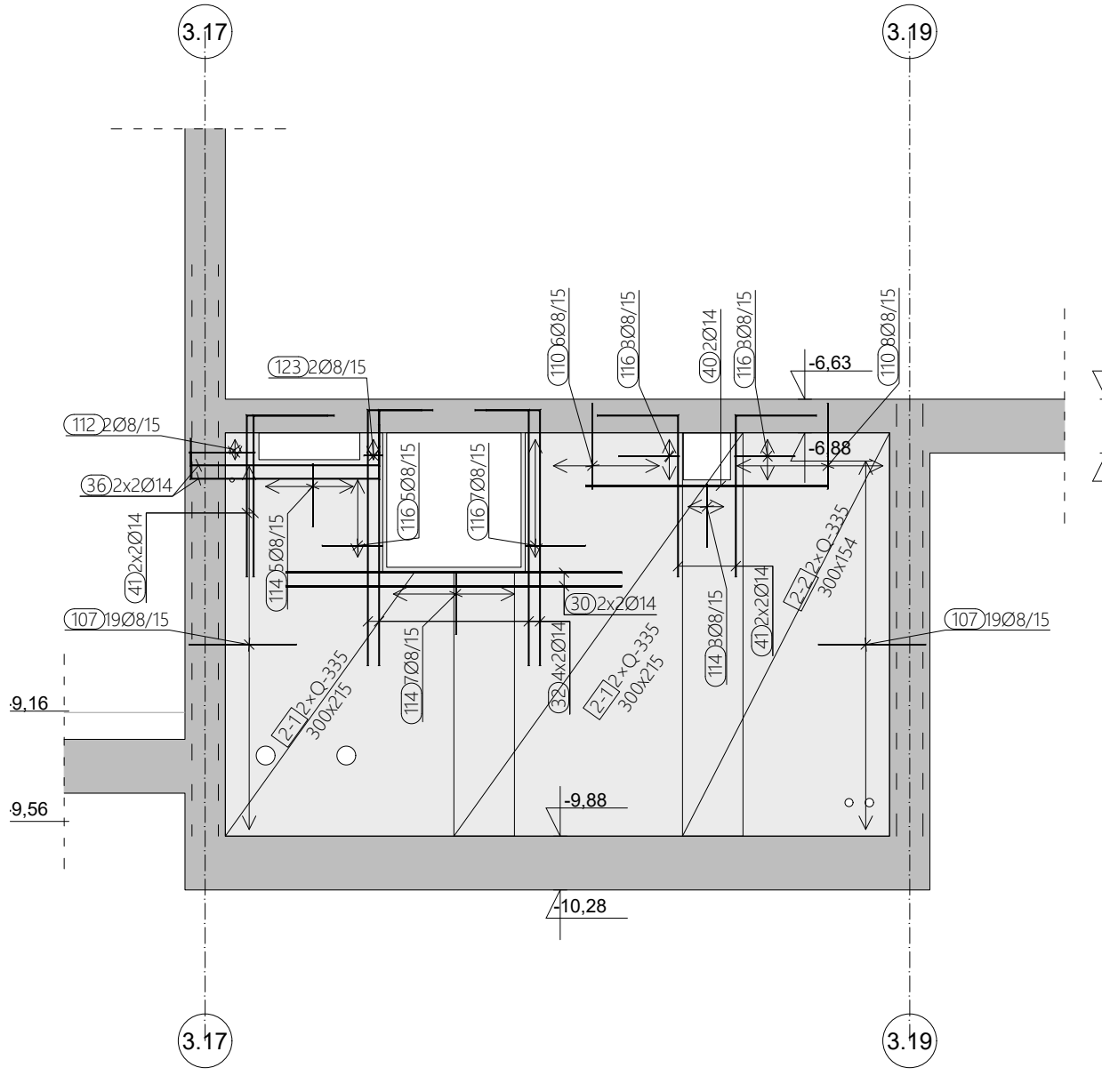

ARMATURA ZIDA U OSI 3.8,
M 1:50

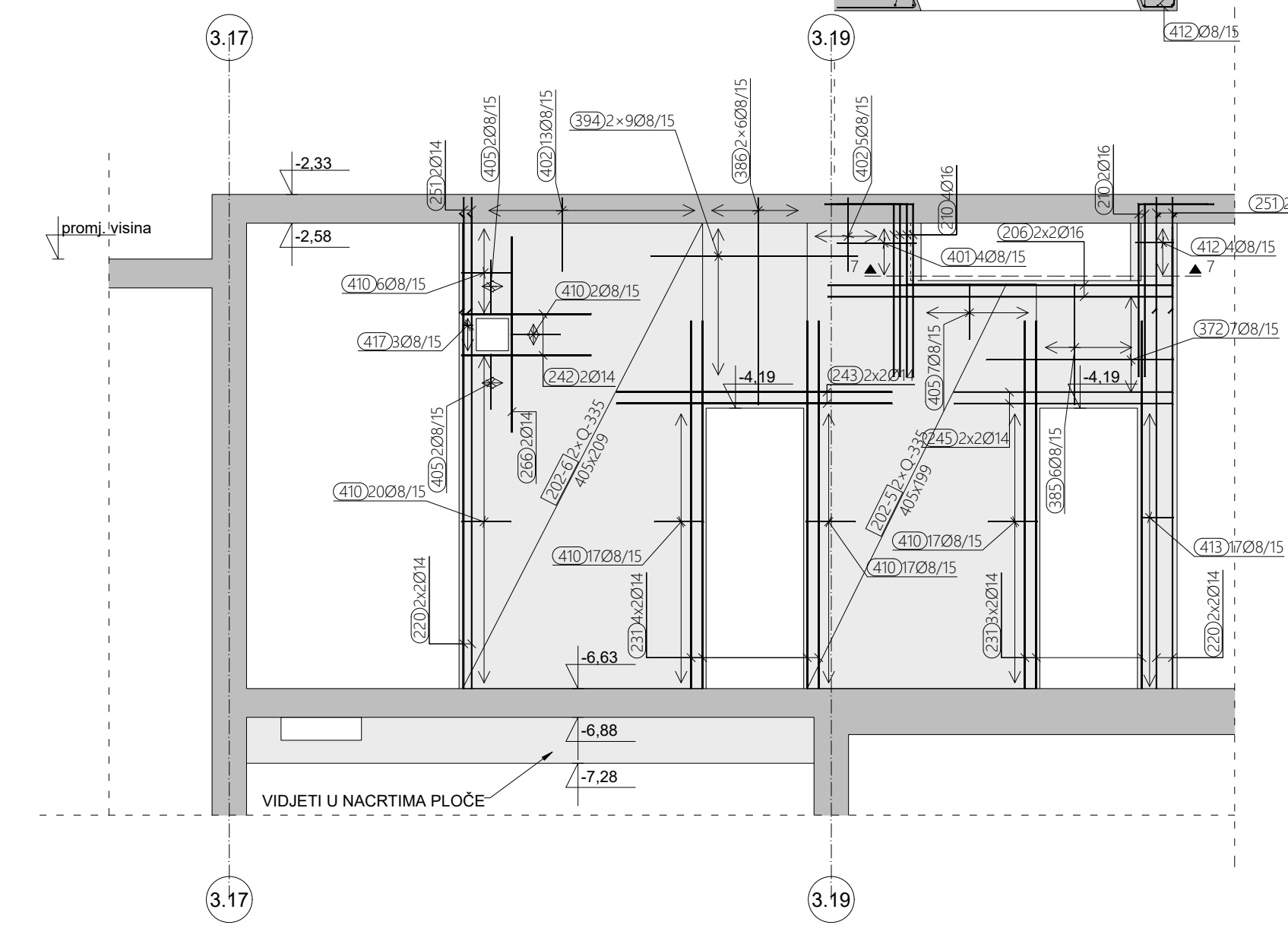

ARMATURA ZIDA U OSI 3.9,
M 1:50

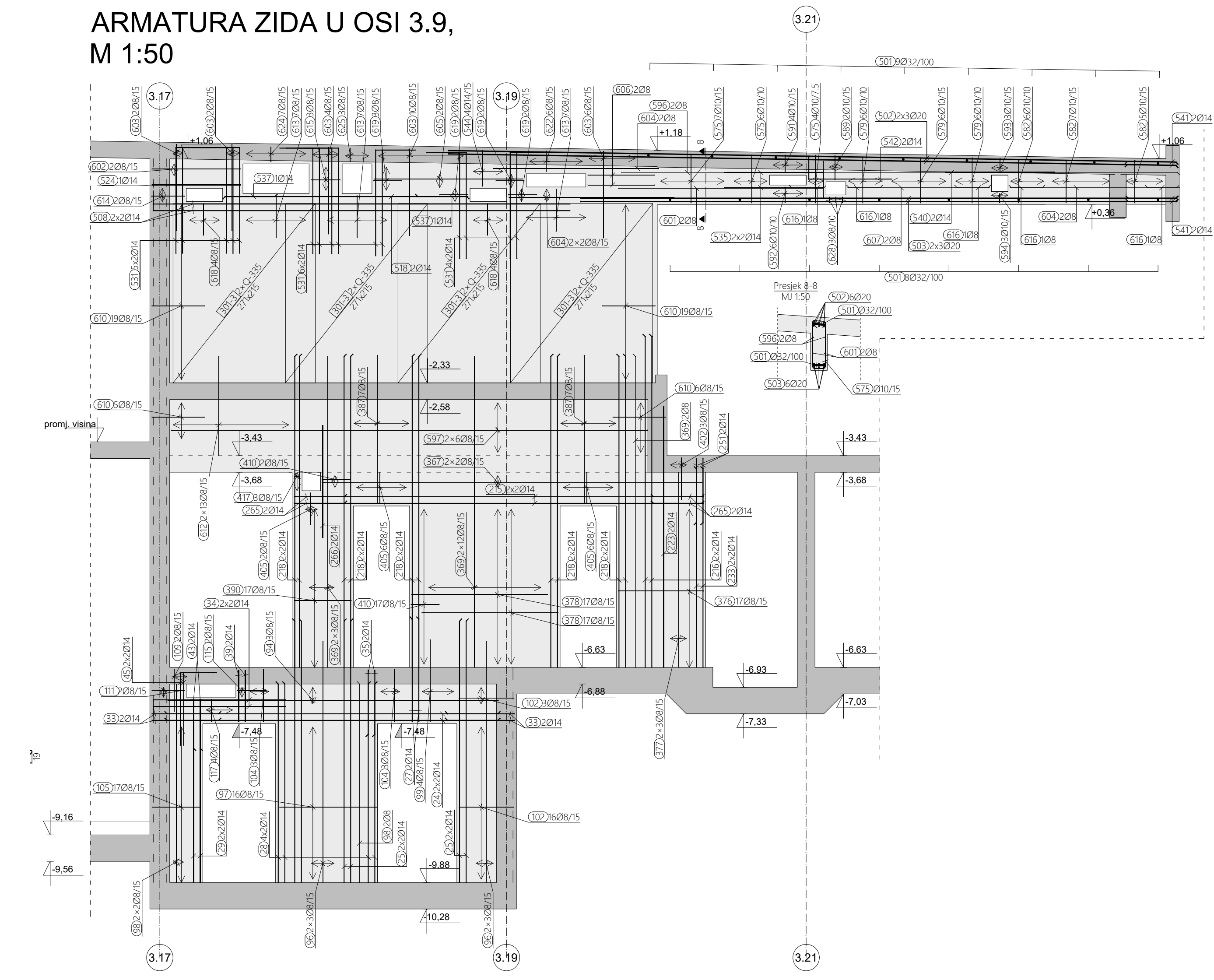

ARMATURA ZIDA U OSI 3.7,
M 1:50

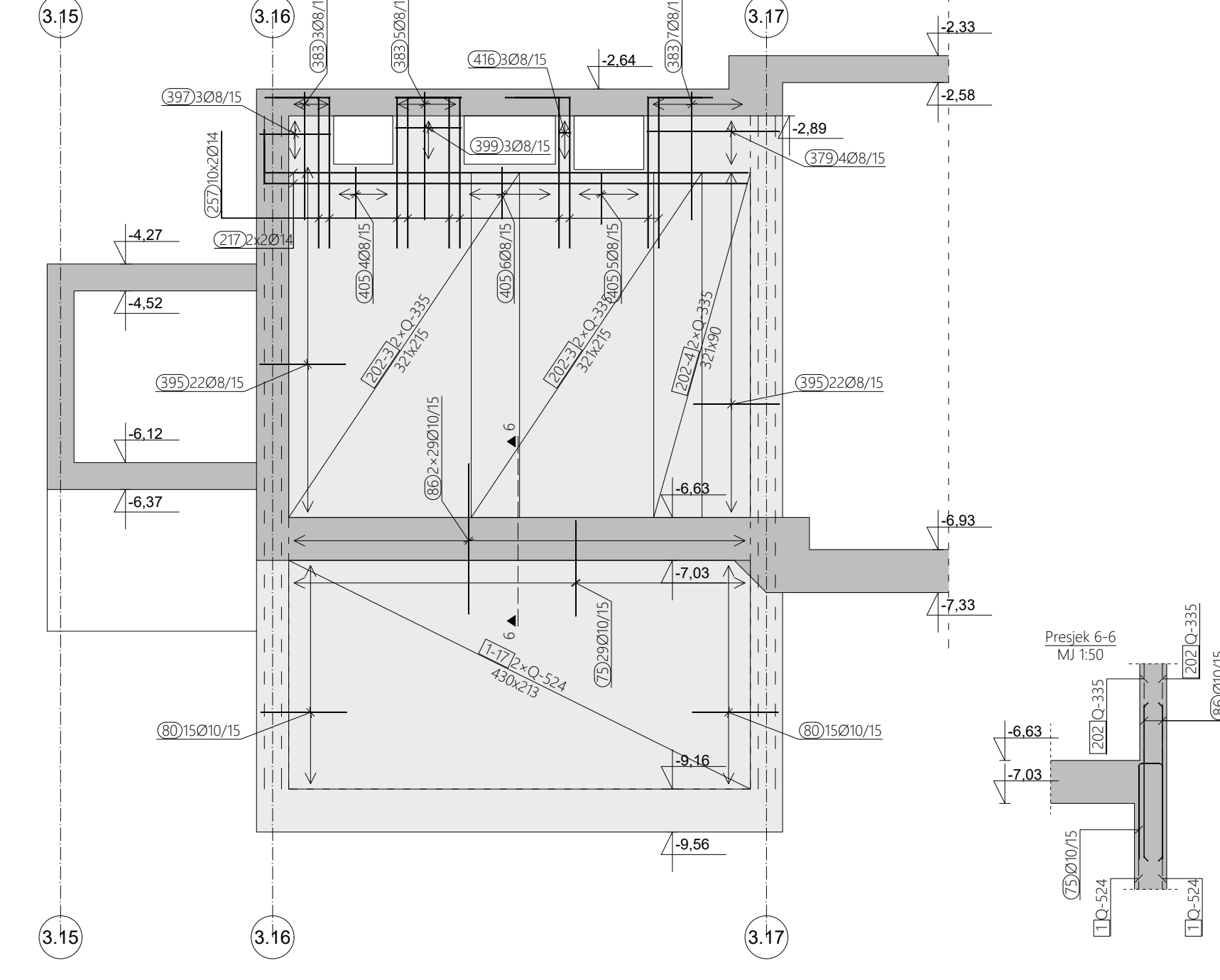

ARMATURA ZIDA U OSI 3.10,
M 1:50

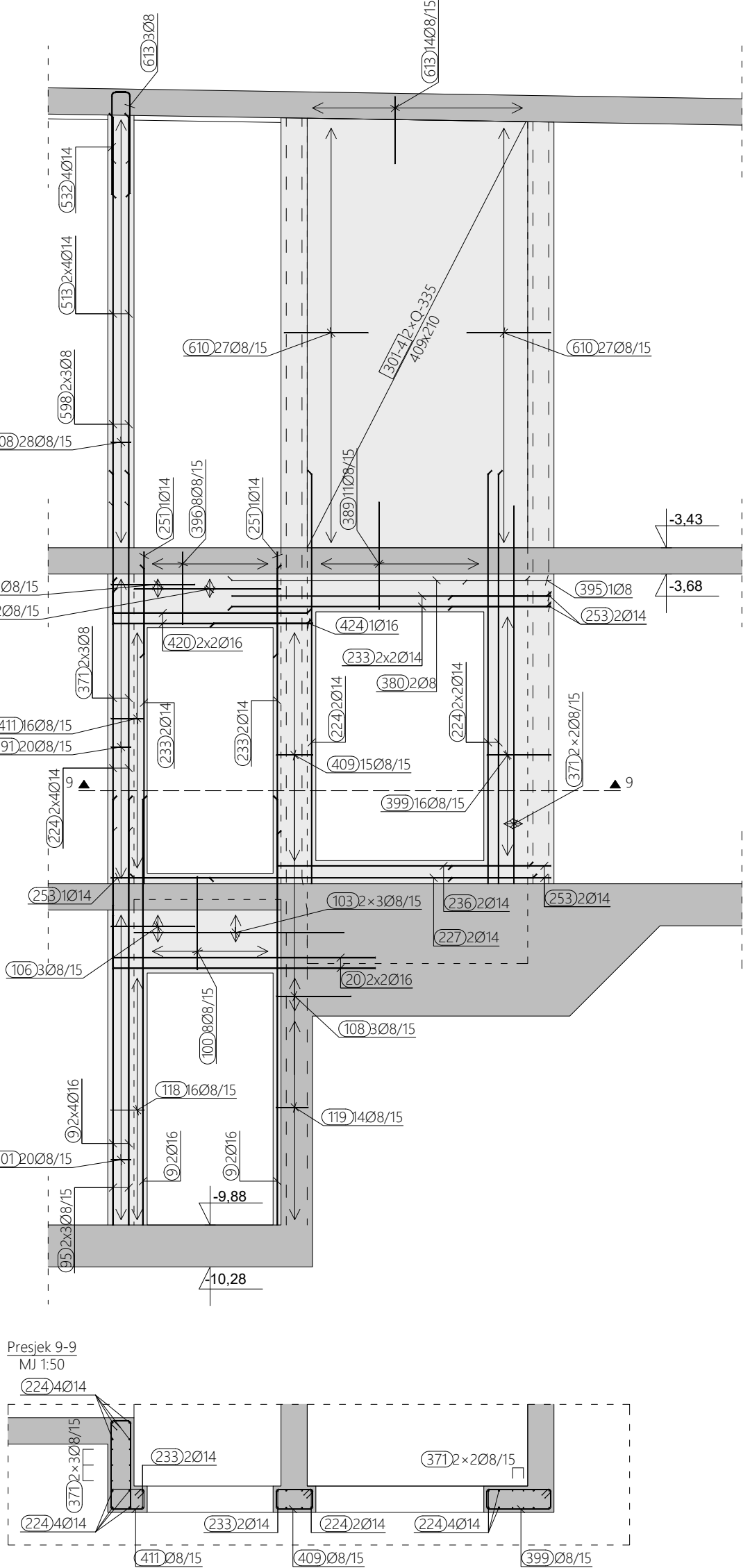

ARMATURA ZIDA U OSI 3.11,
M 1:50

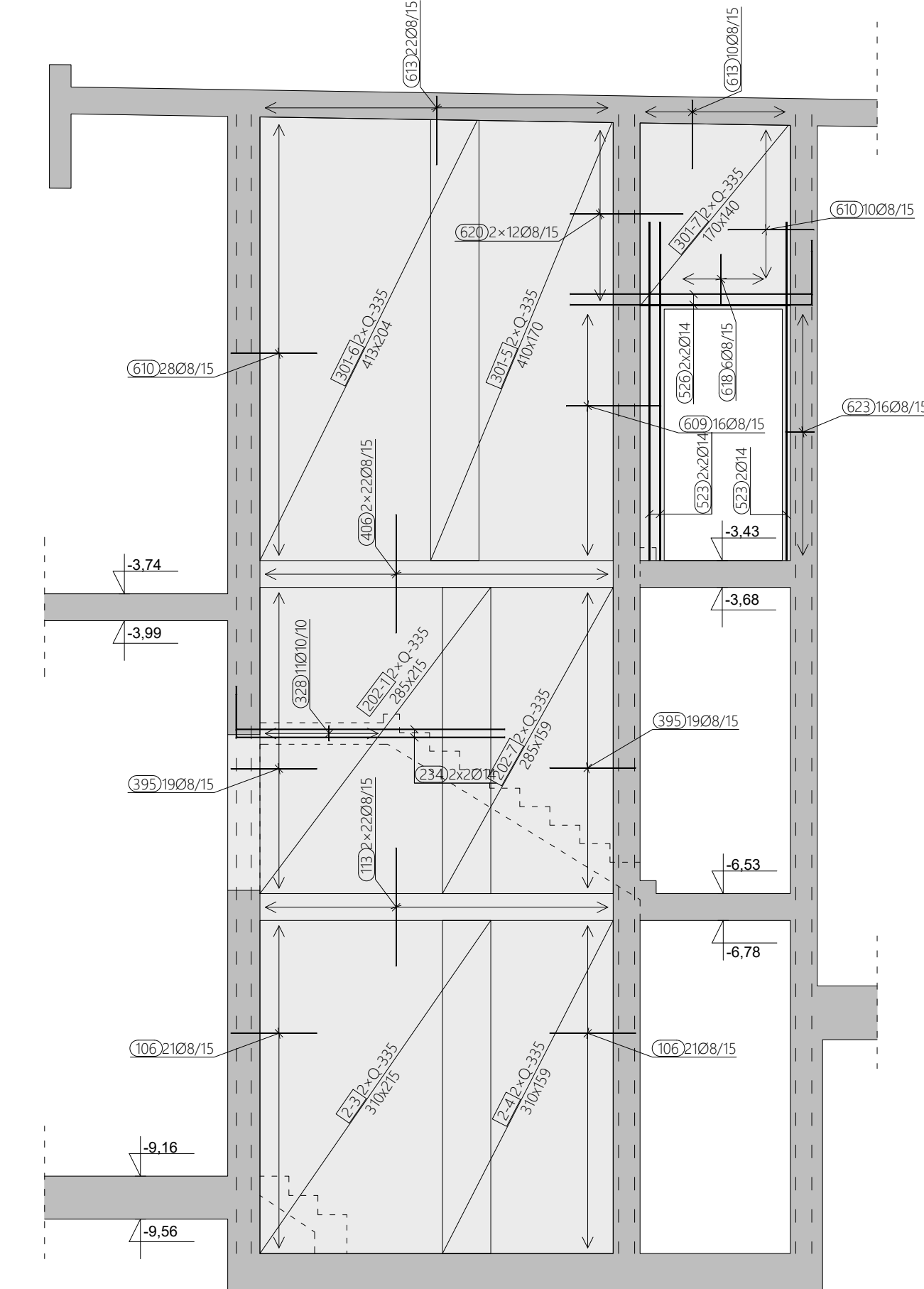

ARMATURA ZIDA U OSI 3.12,
M 1:50

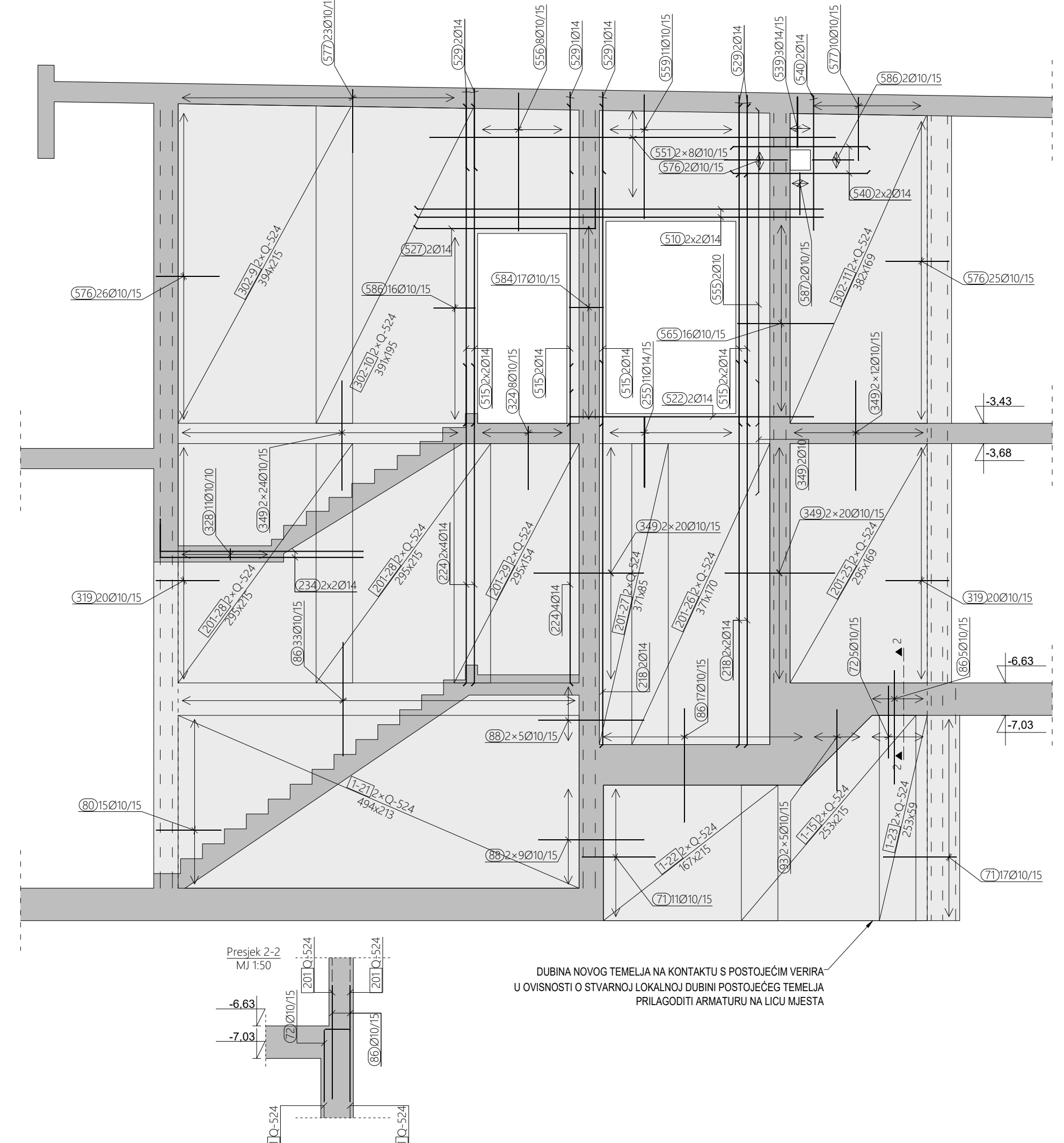

ARMATURA ZIDA U OSI 3.13,
M 1:50

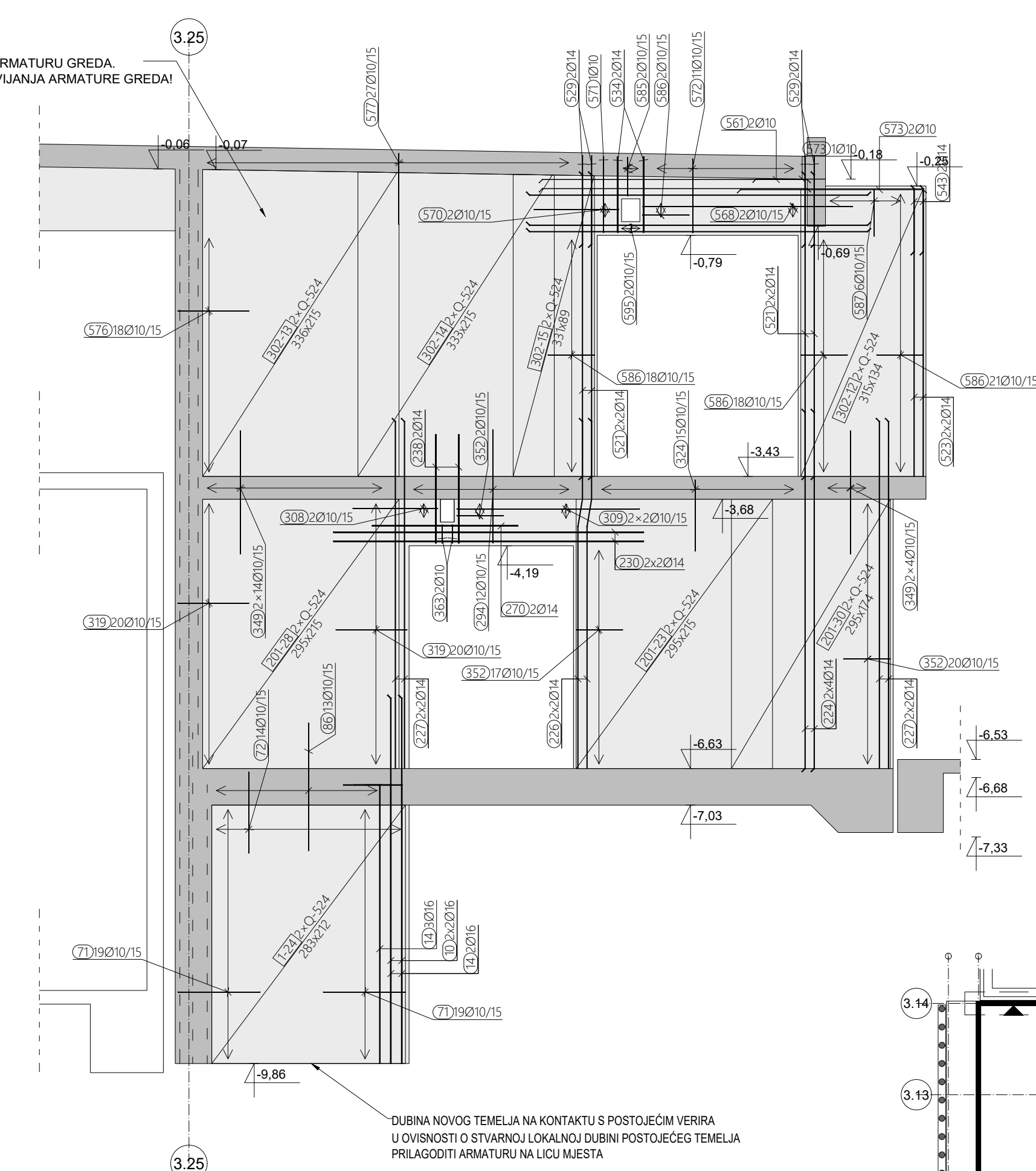

ARMATURA ZIDA U OSI 3.14,
M 1:50

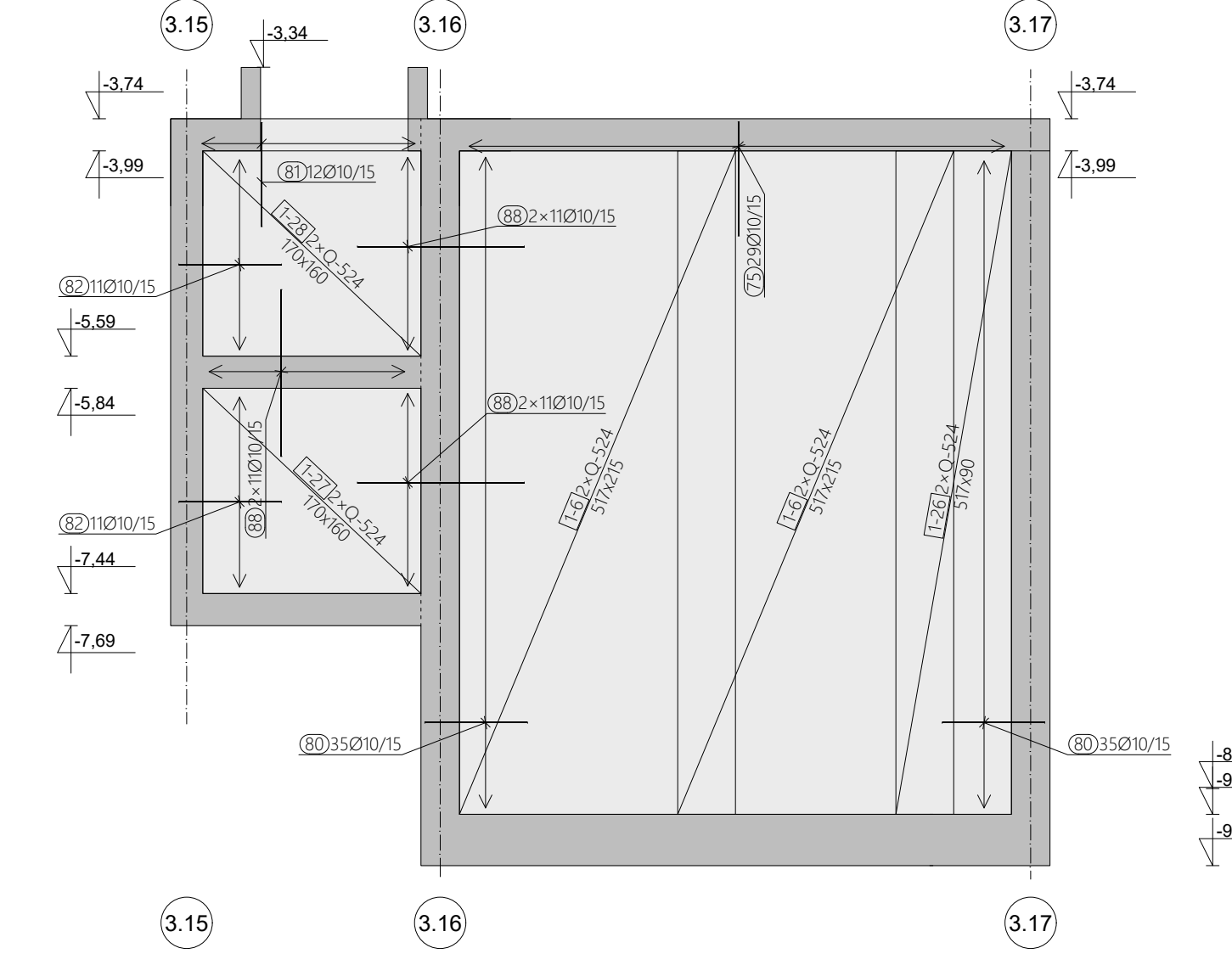

ARMATURA ZIDA IZMEĐU OSI 3.07 I 3.08,
M 1:50

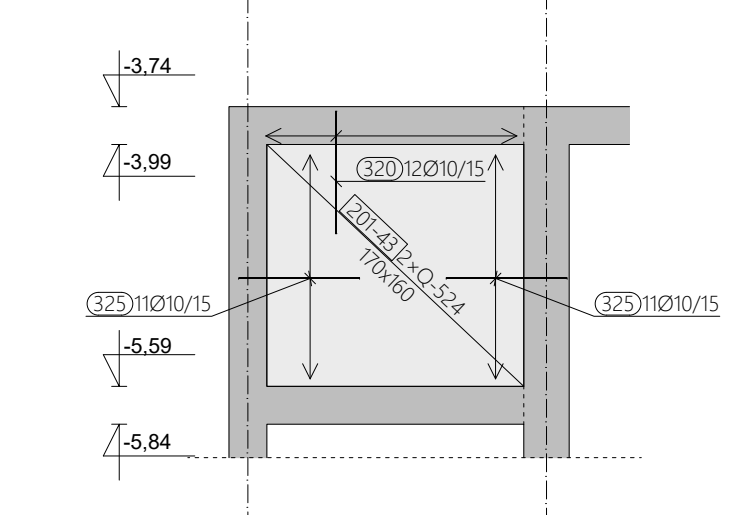

NAPOMENA
Šipke pripremiti i po potrebi rezati na licu mjesta. Preklap 50Ø.

NAPOMENA
Sve dimenzije provjeriti prema važećim planovima opiate.

Klasa betona	C 30/37
Armatura	B 500 B
Zaštitni sloj betona	Pripadajuća klasa armature
dolje	gore
4.0 cm	4.0 cm
Pripadajući armaturni nacrti	
ARM_E-2_313	

PREGLEDNI NACRT M 1:300

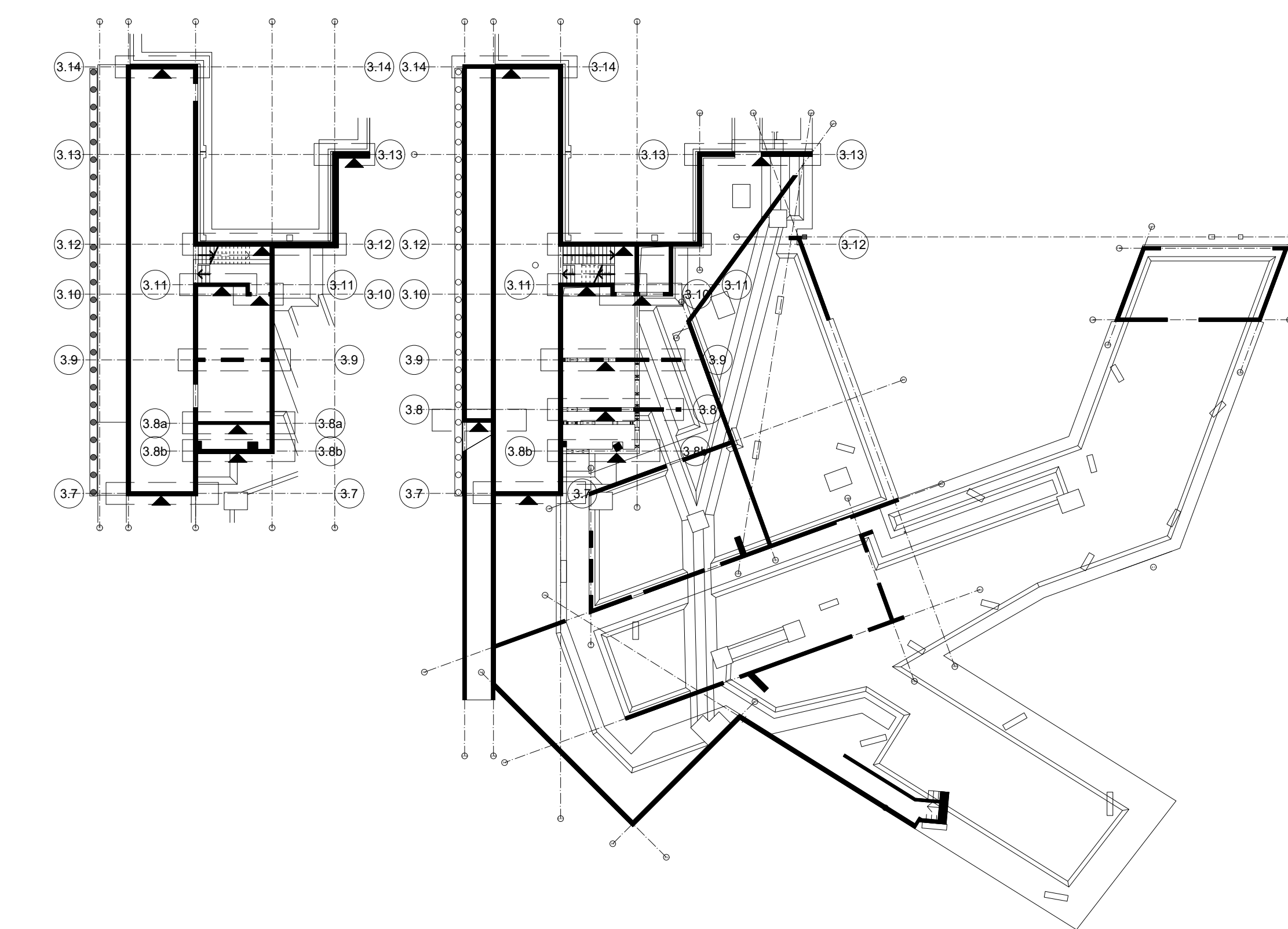

<p>DETALJ POSTAVLJANJA DISTANCERA U ZID E-3</p> <p>TLOCRT ZIDA 20 cm</p> <p>20Ø12/136 (10)</p> <p>20Ø12/136 (10)</p> <p>20Ø12/136 (10)</p> <p>20Ø12/136 (10)</p>	<p>DETALJ POSTAVLJANJA DISTANCERA U ZID E-3</p> <p>TLOCRT ZIDA 25 cm</p> <p>20Ø12/136 (10)</p> <p>20Ø12/136 (10)</p> <p>20Ø12/136 (10)</p> <p>20Ø12/136 (10)</p>	<p>DETALJ POSTAVLJANJA DISTANCERA U ZID E-3</p> <p>TLOCRT ZIDA 30 cm</p> <p>20Ø12/136 (10)</p> <p>20Ø12/136 (10)</p> <p>20Ø12/136 (10)</p> <p>20Ø12/136 (10)</p>	<p>DETALJ POSTAVLJANJA DISTANCERA U ZID E-3</p> <p>TLOCRT ZIDA 40 cm</p> <p>20Ø12/136 (10)</p> <p>20Ø12/136 (10)</p> <p>20Ø12/136 (10)</p> <p>20Ø12/136 (10)</p>	<p>DETALJ POSTAVLJANJA DISTANCERA U ZID E-2</p> <p>TLOCRT ZIDA 20 cm</p> <p>20Ø12/136 (10)</p> <p>20Ø12/136 (10)</p> <p>20Ø12/136 (10)</p> <p>20Ø12/136 (10)</p>	<p>DETALJ POSTAVLJANJA DISTANCERA U ZID E-2</p> <p>TLOCRT ZIDA 25 cm</p> <p>20Ø12/136 (10)</p> <p>20Ø12/136 (10)</p> <p>20Ø12/136 (10)</p> <p>20Ø12/136 (10)</p>	<p>DETALJ POSTAVLJANJA DISTANCERA U ZID E-2</p> <p>TLOCRT ZIDA 30 cm</p> <p>20Ø12/136 (10)</p> <p>20Ø12/136 (10)</p> <p>20Ø12/136 (10)</p> <p>20Ø12/136 (10)</p>	<p>DETALJ POSTAVLJANJA DISTANCERA U ZID E-1</p> <p>TLOCRT ZIDA 25 cm</p> <p>20Ø12/136 (10)</p> <p>20Ø12/136 (10)</p> <p>20Ø12/136 (10)</p> <p>20Ø12/136 (10)</p>	<p>DETALJ POSTAVLJANJA DISTANCERA U ZID E-1</p> <p>TLOCRT ZIDA 30 cm</p> <p>20Ø12/136 (10)</p> <p>20Ø12/136 (10)</p> <p>20Ø12/136 (10)</p> <p>20Ø12/136 (10)</p>
---	---	---	---	---	---	---	---	---

KONSTRUKTA		PEČATI I POTPISI	
KONSTRUKTA d.o.o., za projektiranje i nadzor Bencina 29, ZAGREB, OIB: 666747009 ZIR: PRIVREDNA BANKA 2340009-110164468 TEL: 0136 43 828 FAX: 0136 43 829 MAIL: info@konstrakta.hr		 Tomislav Vreć, dipl. ing. arh. Antonio Maglov, dipl. ing. grad. Antonio Maglov, dipl. ing. grad.	
INVESTITOR	TERME TUNJEVI d.o.o. Ljubička Gata 4, Tunjevo Toplo, 49215 Tunje	GL. PROJEKTANT	Tomislav Vreć, dipl. ing. arh.
GRADJEVNA	NEKOPROJEKCIJSKI FUNKCIJSKI INŽENJERSKI ODJEL CENTRA TERME TUNJEVI	PROJEKT. IZV. PR.	Antonio Maglov, dipl. ing. grad.
IZRAĐIO		IZRAČUNAO	Antonio Maglov, dipl. ing. grad.
LOKACIJA	na k.č.br. 3190/1, k.o. Orednjevec	DATUM:	16.05.2023.
FAZA	IZVEDBENI PROJEKT - ARMATURNI NACRTI	MJERILO:	1:50
REVIZIJA		REVIZIJA	00
SKOPAJ:	ELEMENT - DILATACIJA 3 ARMATURA ZIDOVA	NACRTI BR.:	ARM - E-2 - 313

ARMATURA ZIDA U OSI 3.1,
M 1:50

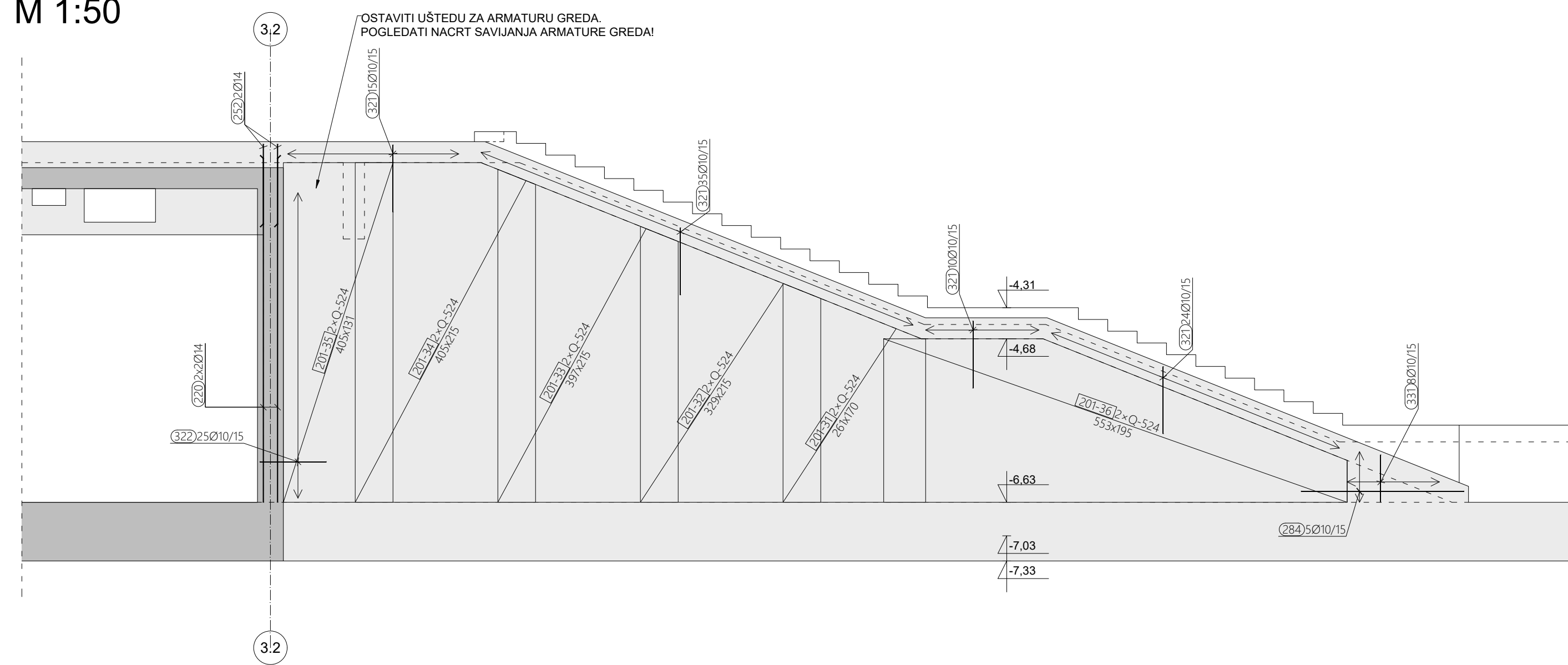

ARMATURA ZIDA U OSI 3.20,
M 1:50

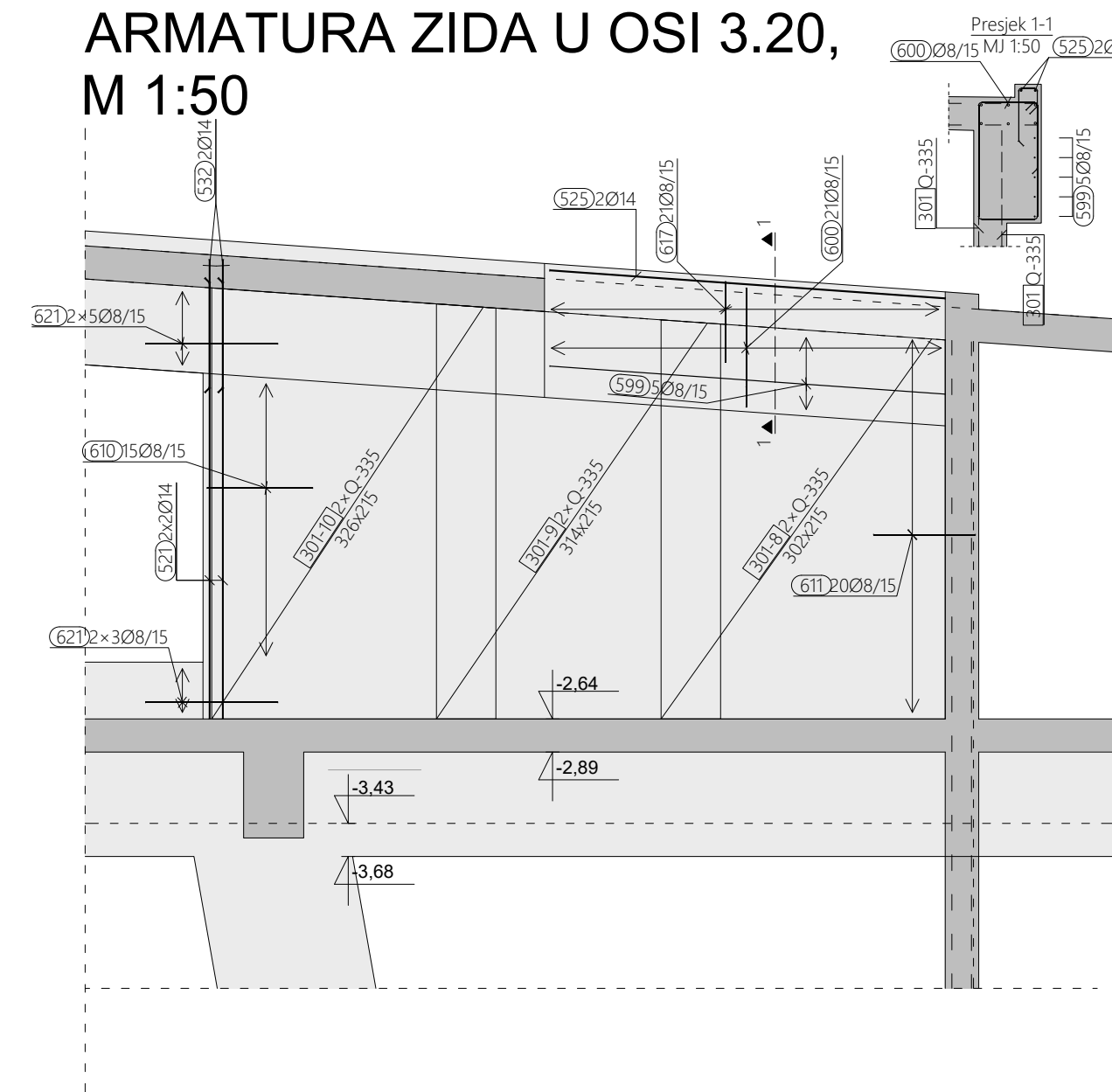

ARMATURA ZIDA U OSI 3.23,
M 1:50

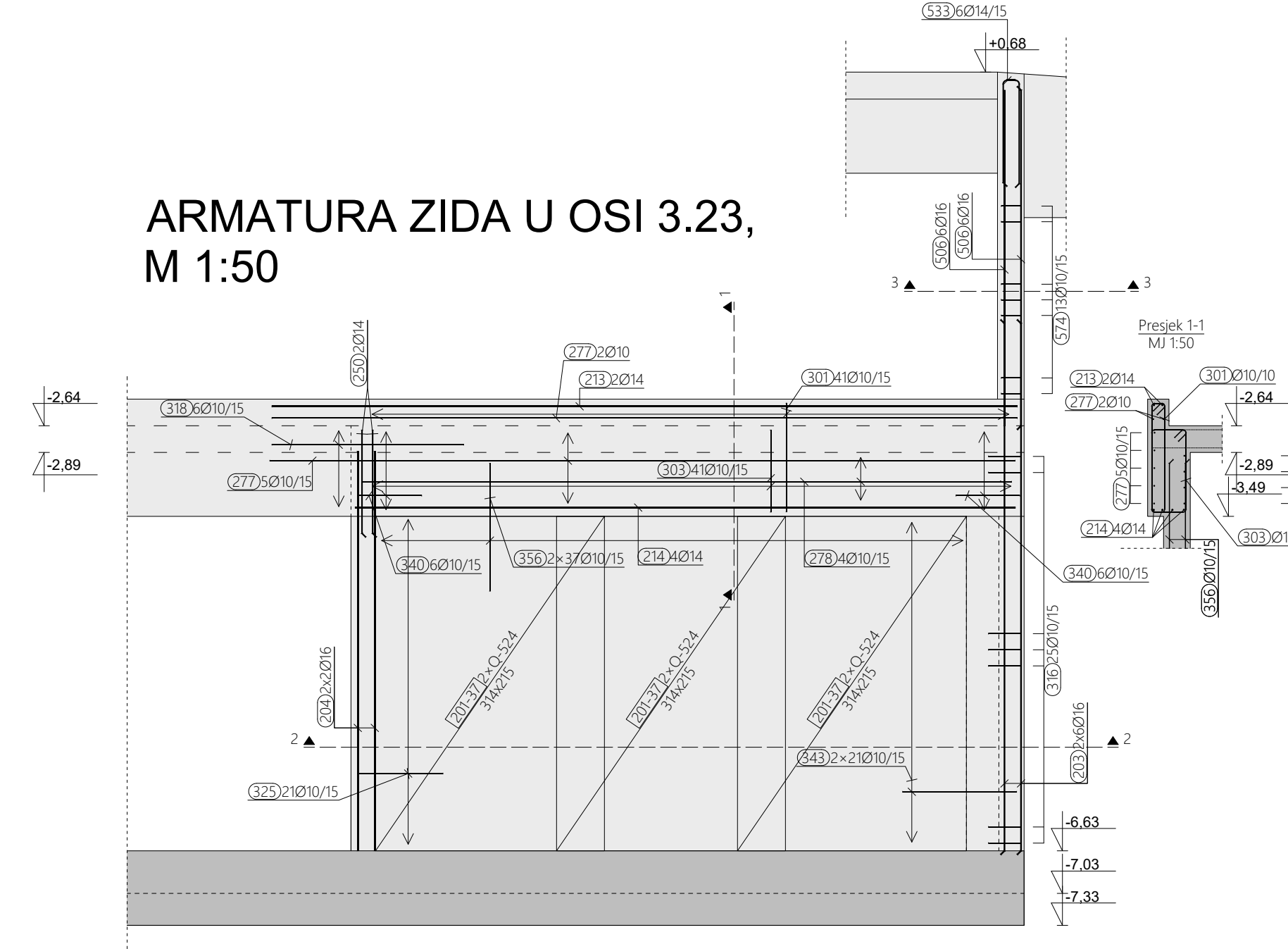

ARMATURA ZIDA KOD OSI 3.19 (ZID LIFTA),
M 1:50

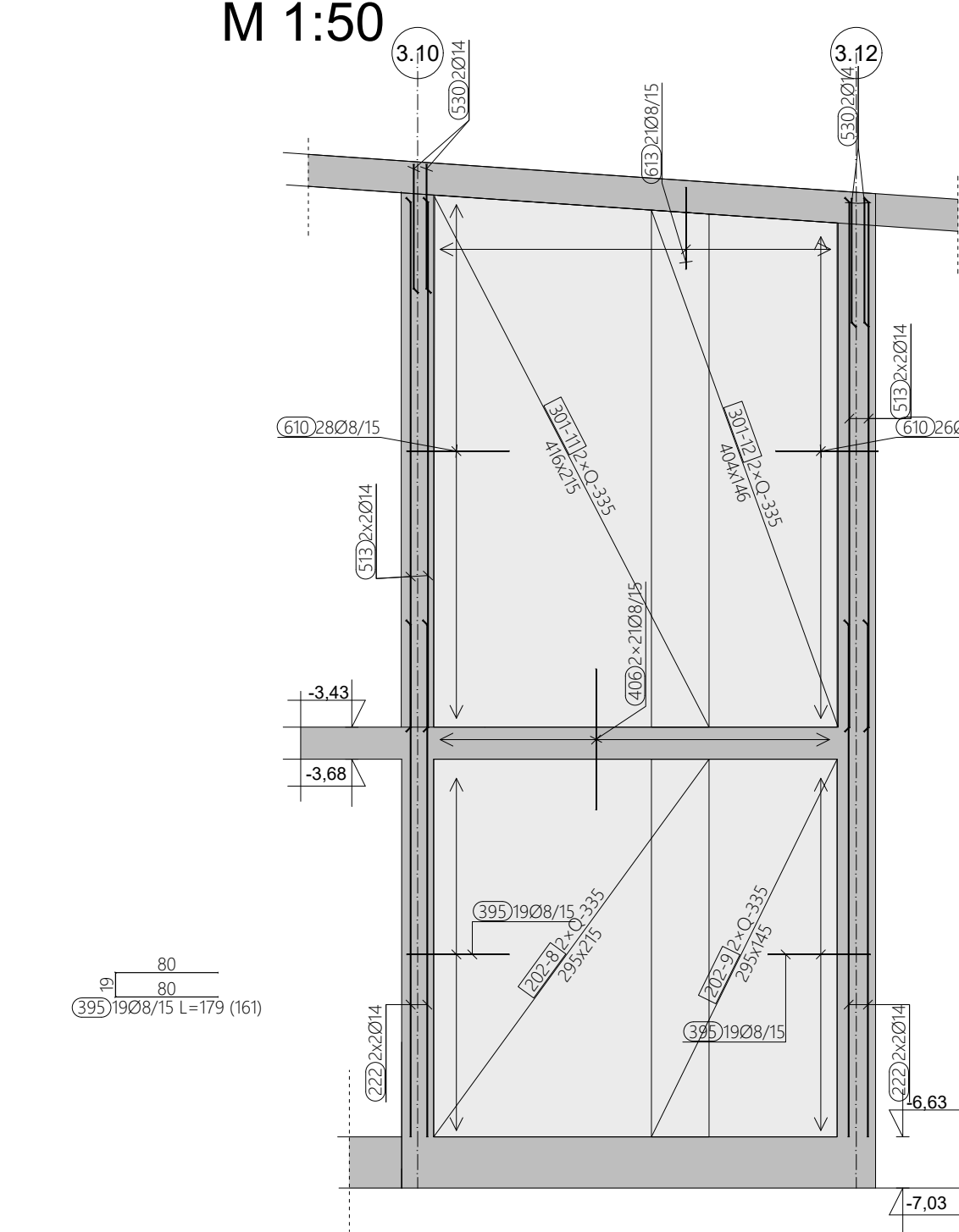

PREGLEDNI NACRT M 1:300

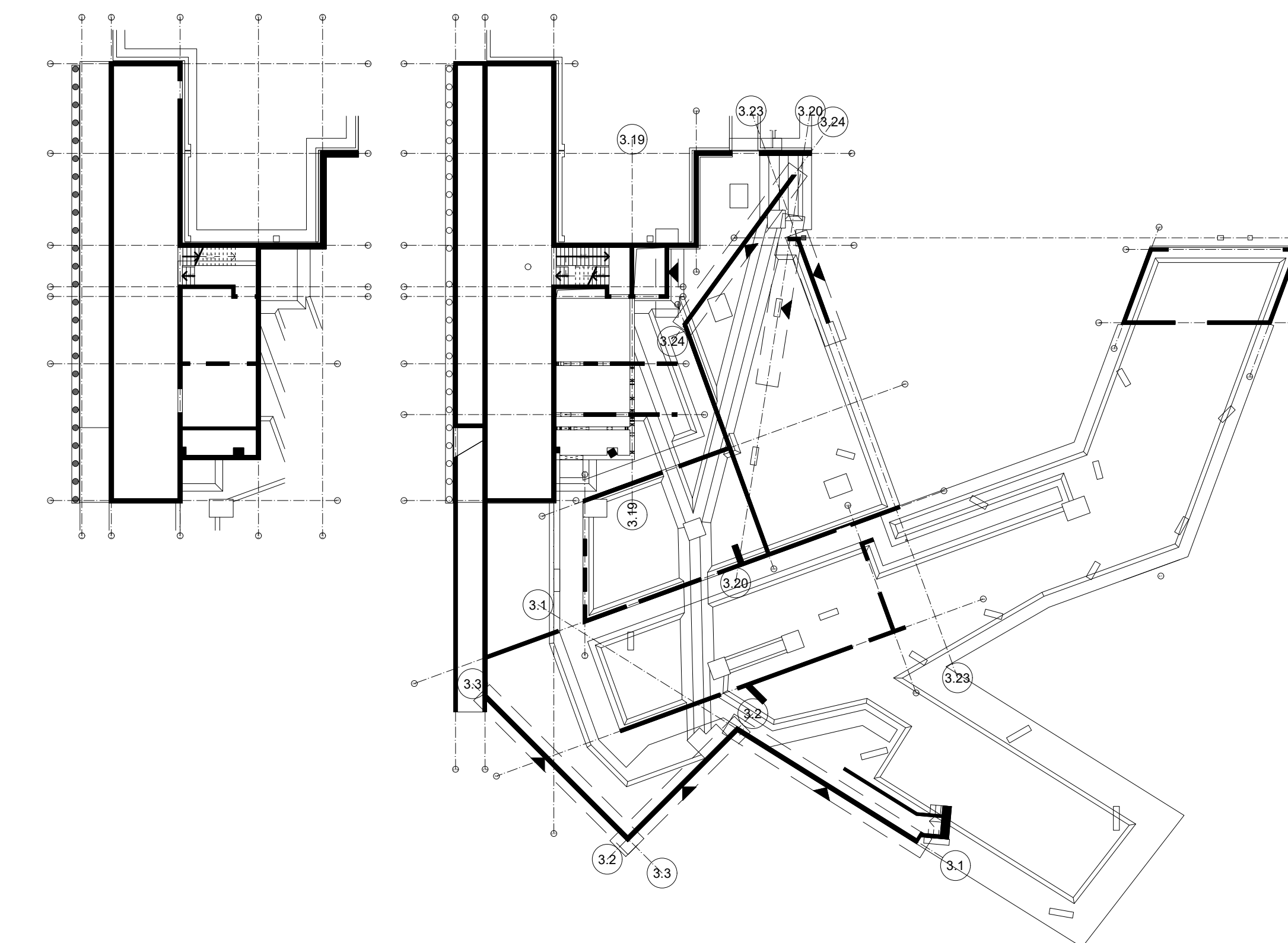

ARMATURA ZIDA U OSI 3.24,
M 1:50

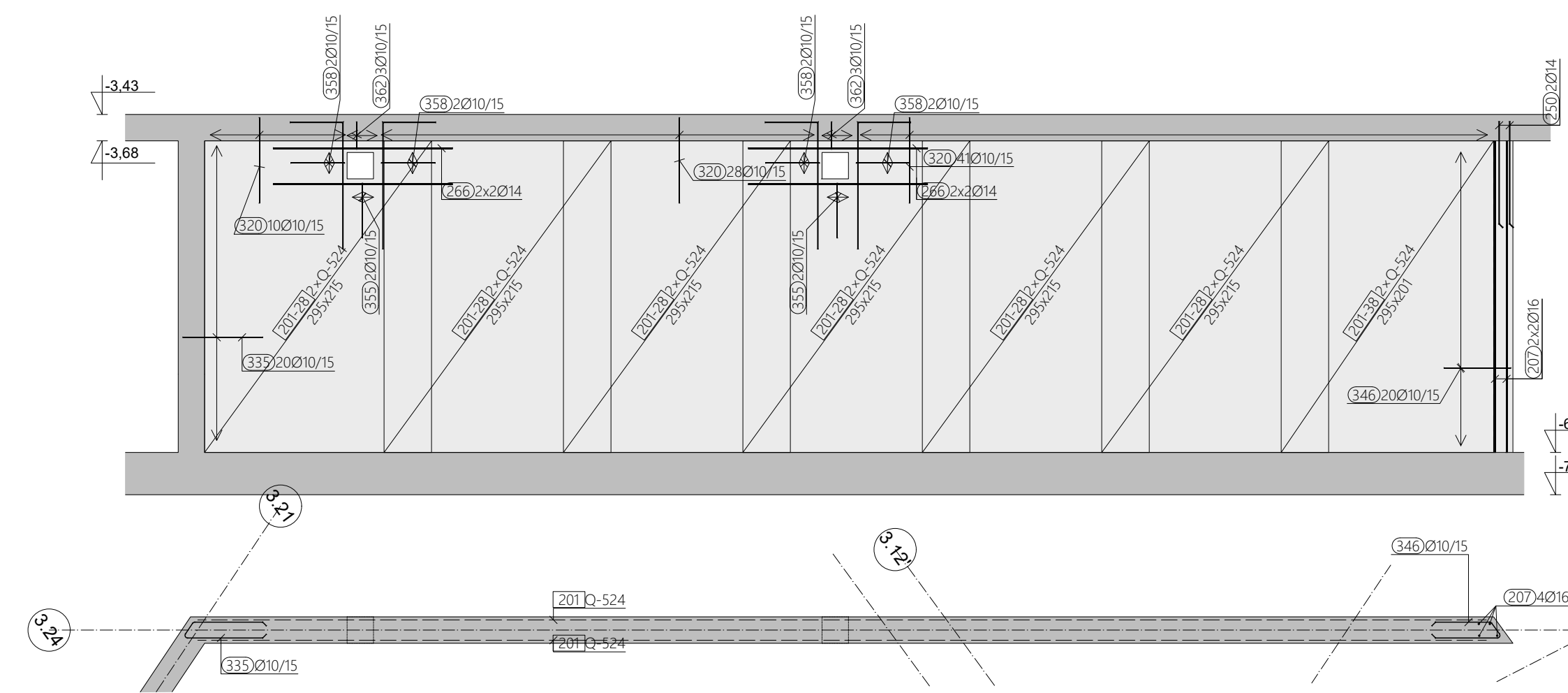

ARMATURA ZIDA U OSI 3.2,
M 1:50

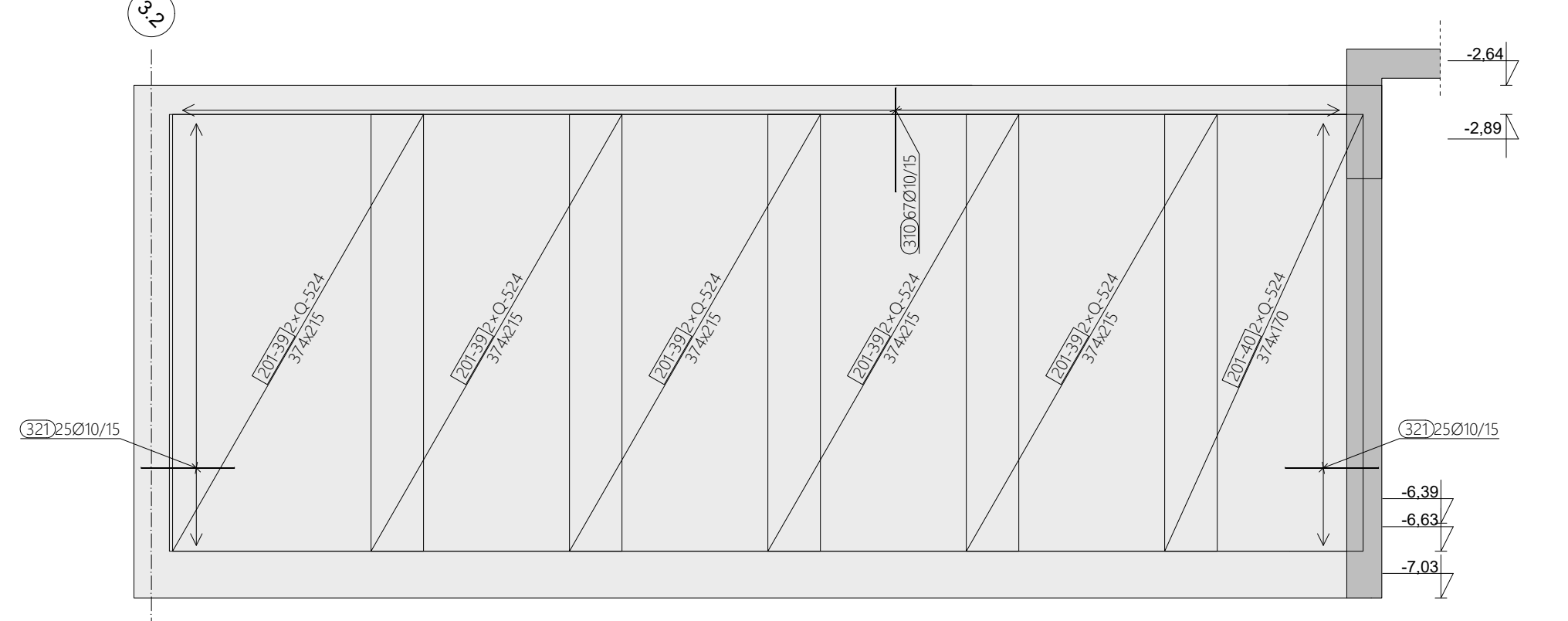

ARMATURA ZIDA KOD OSI 3.1,
M 1:50

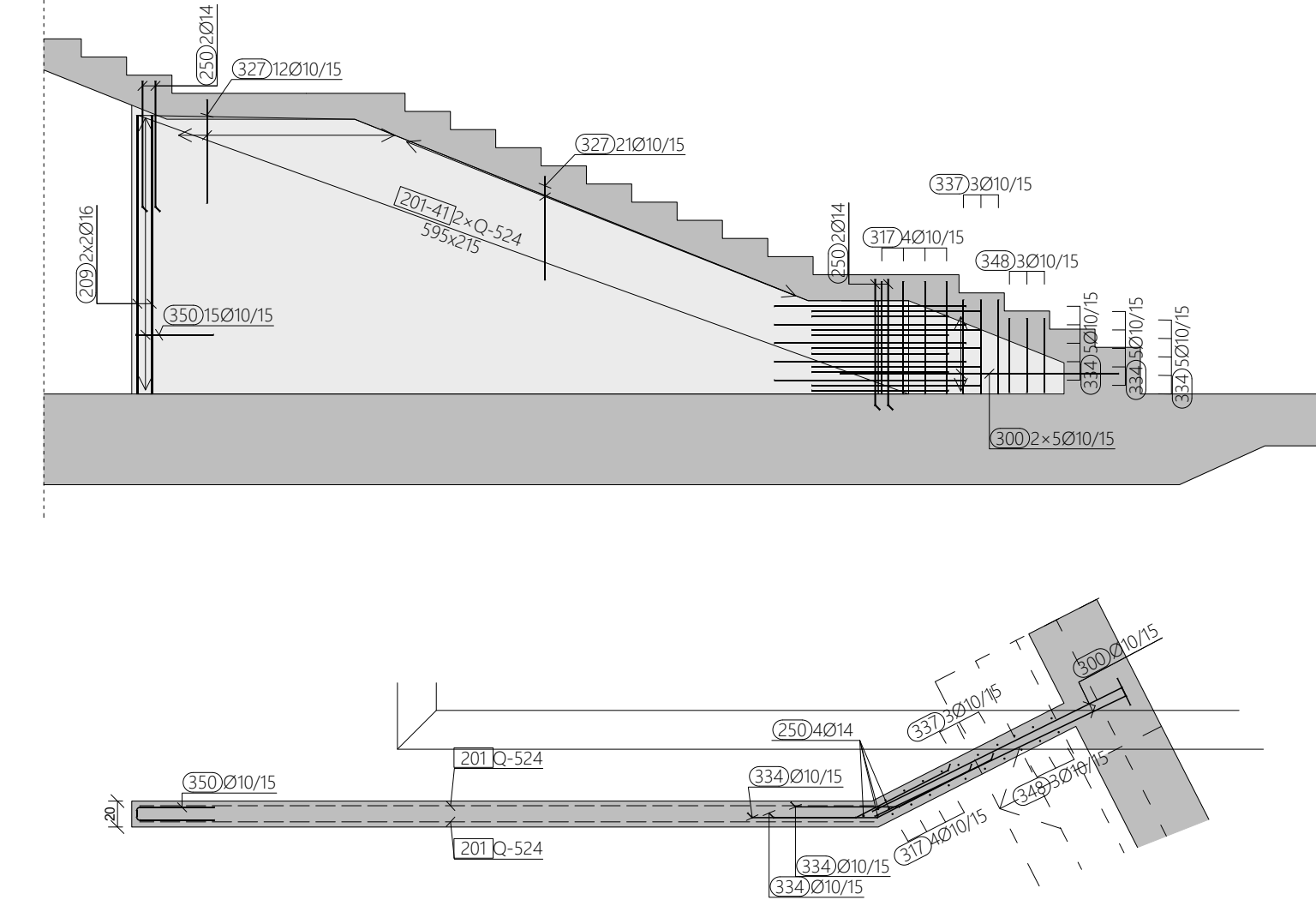

ARMATURA ZIDA U OSI 3.3,
M 1:50

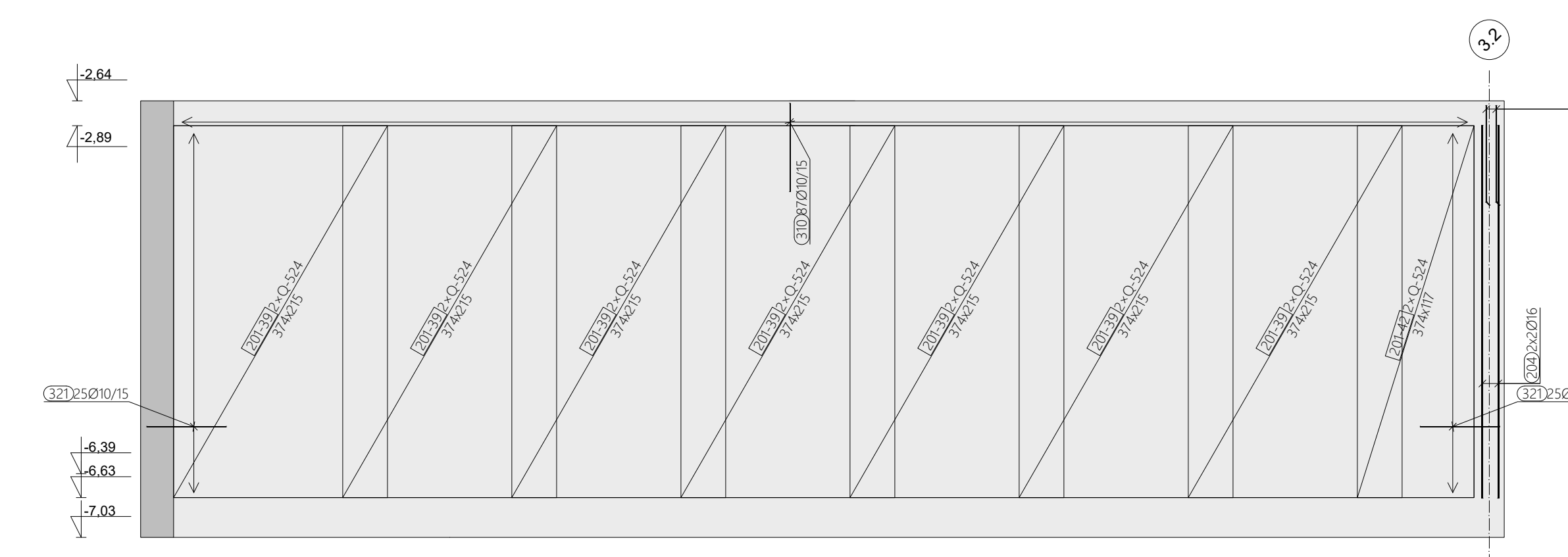

NAPOMENA

Šipke prilagoditi i po potrebi rezati na licu mjesta. Preklop 50Ø.

NAPOMENA

Sve dimenzije provjeriti prema važećim planovima optate.

Klasa betona	C 30/37
Armatura	B 500 B
Zaštitni sloj betona	
dole	gore
4,0 cm	4,0 cm
Pripadajući armaturni nacrti	
ARM_E-2_314	

DETALJ POSTAVLJANJA
DISTANCERA U ZID E-3

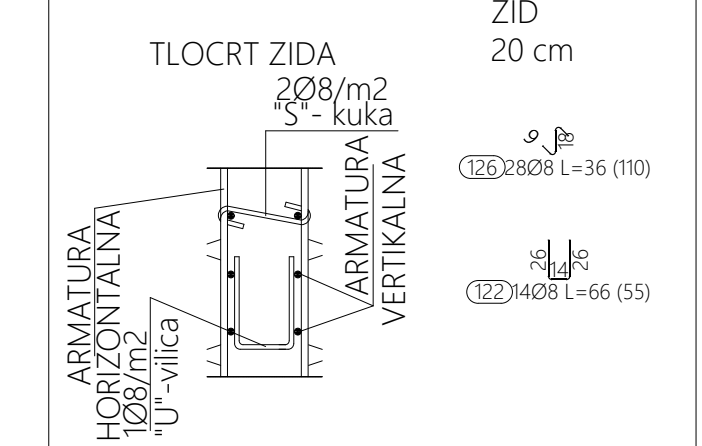

DETALJ POSTAVLJANJA
DISTANCERA U ZID E-3

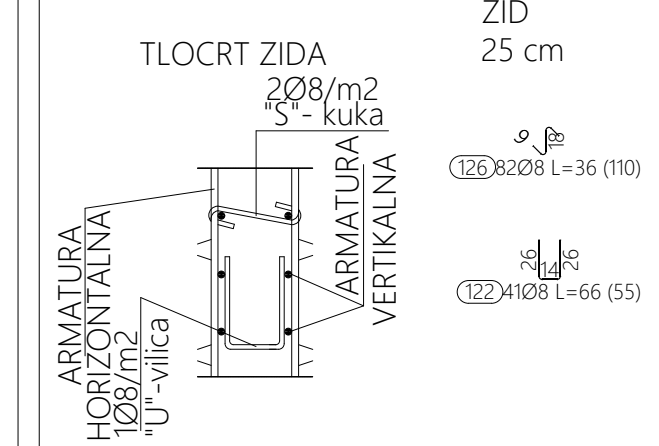

DETALJ POSTAVLJANJA
DISTANCERA U ZID E-3

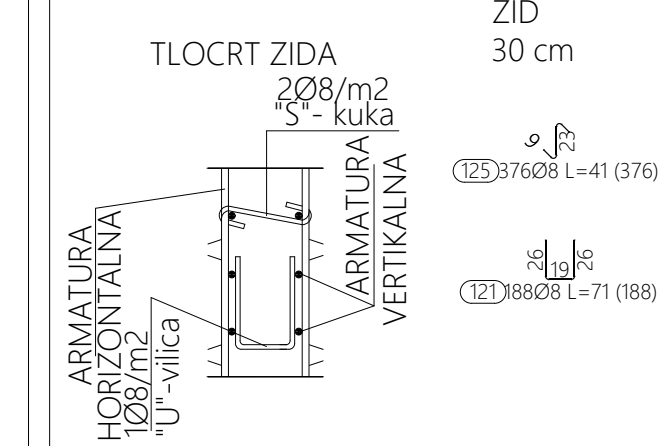

DETALJ POSTAVLJANJA
DISTANCERA U ZID E-3

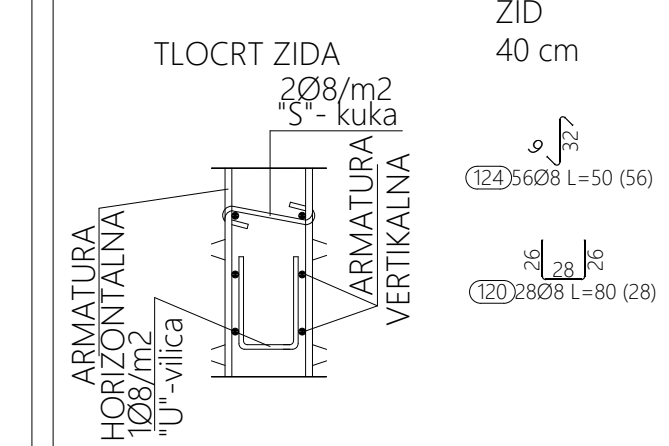

DETALJ POSTAVLJANJA
DISTANCERA U ZID E-2

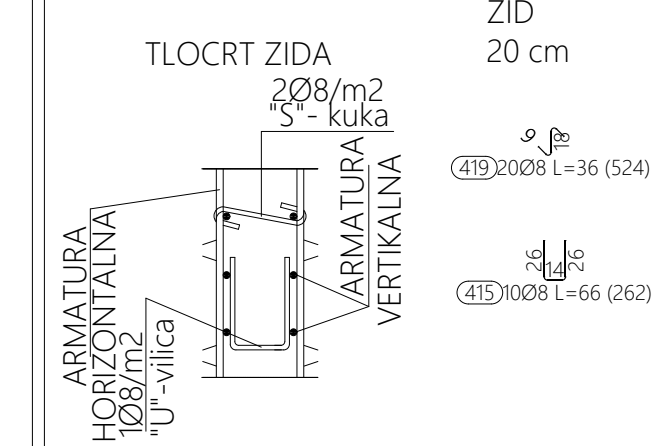

DETALJ POSTAVLJANJA
DISTANCERA U ZID E-2

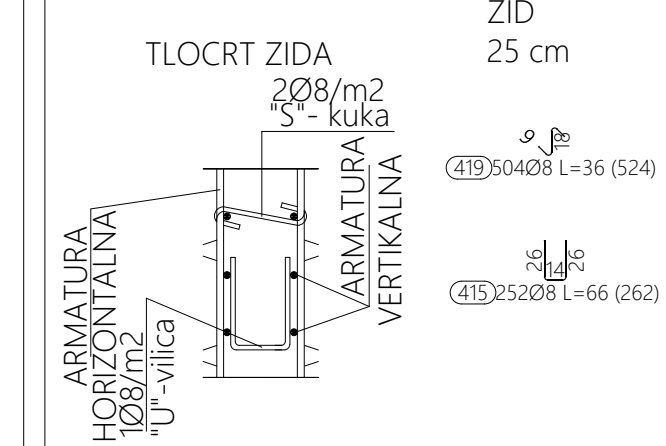

DETALJ POSTAVLJANJA
DISTANCERA U ZID E-2

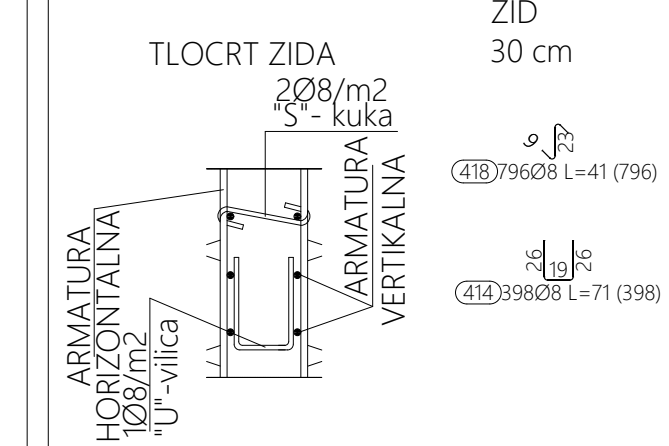

DETALJ POSTAVLJANJA
DISTANCERA U ZID E-1

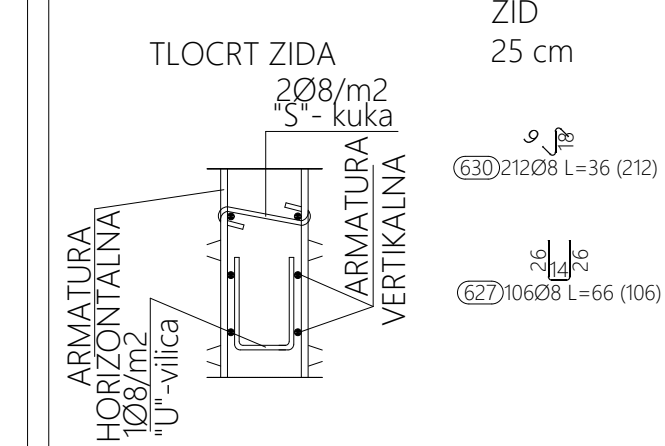

DETALJ POSTAVLJANJA
DISTANCERA U ZID E-1

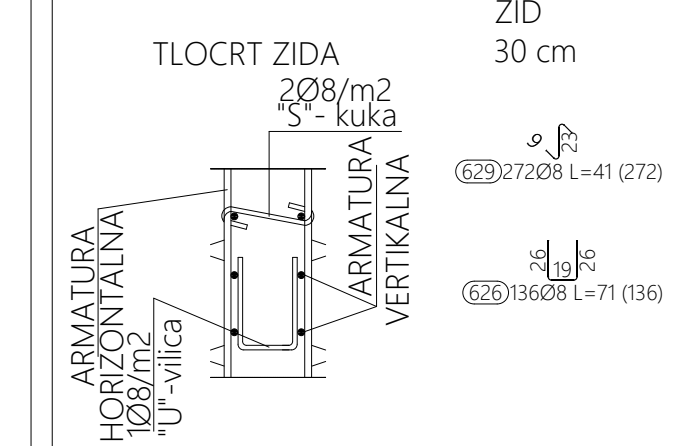

KONSTRUKTA		PEČAT I POTPIŠ
KONSTRUKTA d.o.o., za projektiranje i nadzor Bencikova 29, ZAGREB, OIB: 6667470019 ZIR: PRIVREDNA BANKA 2340009-1110164488 TEL: 0126 43 828 FAX: 0126 43 829 MAIL: info@konstrakta.hr		
INVESTITOR: TERME TUNJELO d.o.o. Ljudevitova Gajka 4, Tunjele Toplice, 49215 Tunjele	GL. PROJEKTANT: Tomislav Vrhel, dipl. ing. arh.	
GRADJEVINA: REKONSTRUKCIJA TERMSKOG REKREACIJSKOG CENTRA TERME TUNJELE	PROJEKT IZV. PR: IZRAČIO: Antonio Maglov, dipl. ing. grad.	
LOKACIJA: na k.č.br. 3190/1, k.o. Orednjevec	DATUM: 04.05.2023.	
FAZA: IZVEDBENI PROJEKT - ARMATURNI NACRTI	M:RELO: 1:50	REVIZIJA: 00
SARJAVI: ELEMENT - DILATACIJA 3 ARMATURA ZIDOVA ZIDOVU	NACRTI BR: ARM - E-2 - 314	

ISKAZ ARMATURE		
GRAĐEVINA:	REKONSTRUKCIJA TERMALNOG REKREACIJSKOG CENTRA TERME TUHELJ	
ISKAZ UZ NACRT:	ARM_E-2-312-314	
SADRŽAJ:	ARMATURA ZIDOVA E-1	
DATUM:	srpanj, 2023.	1/12

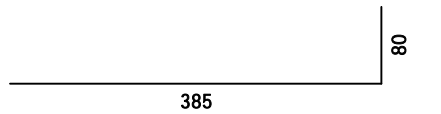
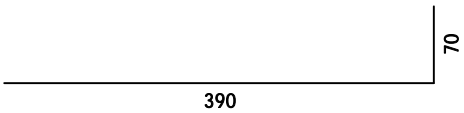
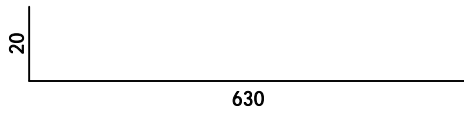
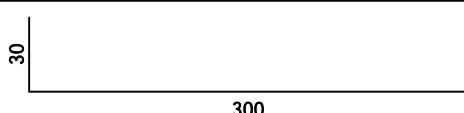
Šipke - specifikacija						
ozn	oblik i mjere [cm]	Ø	lg [m]	n [kom]	lgn [m]	Napomena
Armatura zidova E-1 (1 kom)						
501	20	32	0.20	17	3.40	
502	1100	20	11.00	6	66.00	
503	900	20	9.00	6	54.00	
504		20	4.65	12	55.80	
505		20	4.60	8	36.80	
506	315	16	3.15	12	37.80	
507	1040	14	10.40	4	41.60	
508		14	6.50	4	26.00	
509	505	14	5.05	2	10.10	
510	500	14	5.00	4	20.00	
511	445	14	4.45	4	17.80	
512	425	14	4.25	16	68.00	
513	410	14	4.10	24	98.40	
514	395	14	3.95	4	15.80	
515	390	14	3.90	16	62.40	
516	380	14	3.80	4	15.20	
517	370	14	3.70	18	66.60	
518	365	14	3.65	2	7.30	
519	355	14	3.55	8	28.40	
520	340	14	3.40	8	27.20	
521	330	14	3.30	16	52.80	
522		14	3.30	2	6.60	
523	315	14	3.15	10	31.50	





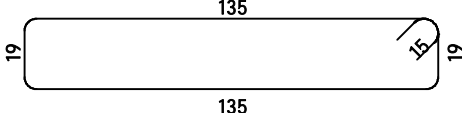
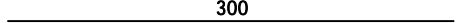
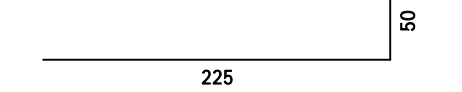
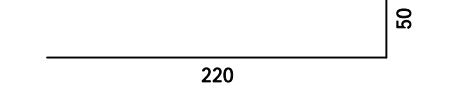
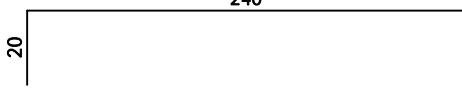
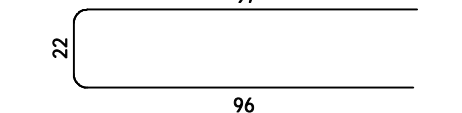
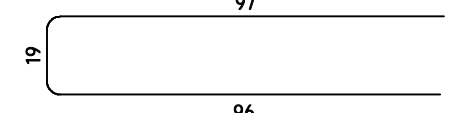
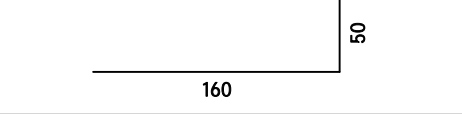
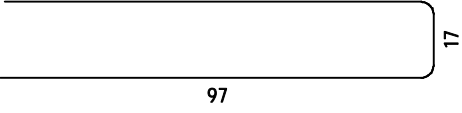
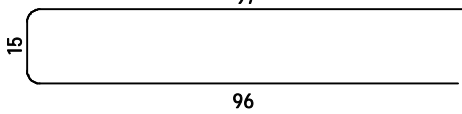
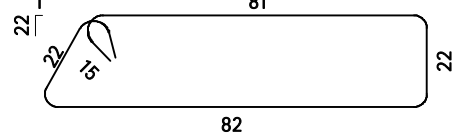
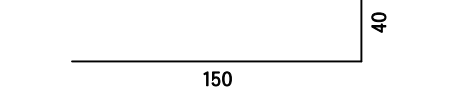

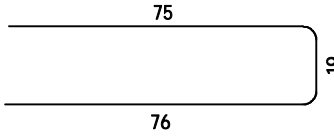
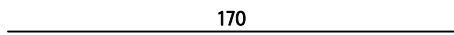
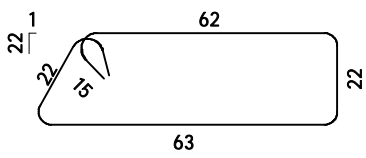
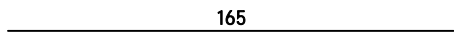
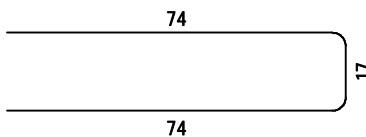

ISKAZ ARMATURE

GRAĐEVINA:	REKONSTRUKCIJA TERMALNOG REKREACIJSKOG CENTRA TERME TUHELJ	
ISKAZ UZ NACRT:	ARM_E-2-312-314	
SADRŽAJ:	ARMATURA ZIDOVA E-1	
DATUM:	srpanj, 2023.	2/12

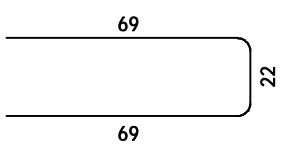
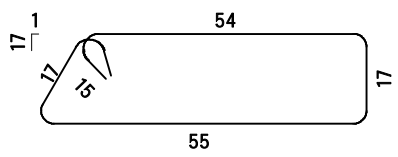
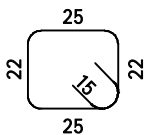
Šipke - specifikacija						
ozn	oblik i mjere [cm]	Ø	lg [m]	n [kom]	lgn [m]	Napomena
524		14	3.38	1	3.38	
525		14	3.00	2	6.00	
526		14	2.75	4	11.00	
527		14	2.70	2	5.40	
528		14	2.60	4	10.40	
529		14	2.15	38	81.70	
530		14	2.12	4	8.48	
531		14	2.10	30	63.00	
532		14	2.10	12	25.20	
533		14	2.08	6	12.48	
534		14	2.37	2	4.74	
535		14	1.90	4	7.60	

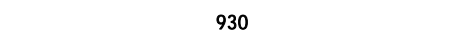

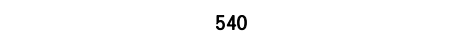

ISKAZ ARMATURE

GRAĐEVINA:	REKONSTRUKCIJA TERMALNOG REKREACIJSKOG CENTRA TERME TUHELJ	
ISKAZ UZ NACRT:	ARM_E-2-312-314	
SADRŽAJ:	ARMATURA ZIDOVA E-1	
DATUM:	srpanj, 2023.	3/12

Šipke - specifikacija						
ozn	oblik i mjere [cm]	Ø	lg [m]	n [kom]	lgn [m]	Napomena
536		14	1.70	4	6.80	
537		14	1.70	2	3.40	
538		14	1.70	4	6.80	
539		14	1.99	3	5.97	
540		14	1.65	14	23.10	
541		14	1.65	4	6.60	
542		14	1.60	2	3.20	
543		14	1.60	2	3.20	
544		14	1.73	4	6.92	
545		14	1.24	3	3.72	
546		10	12.00	6	72.00	
547		10	9.30	6	55.80	
548		10	7.60	6	45.60	
549		10	6.60	18	118.80	
550		10	5.40	24	129.60	
551		10	5.00	16	80.00	

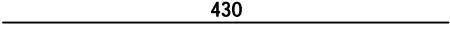
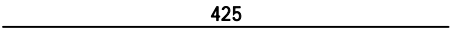
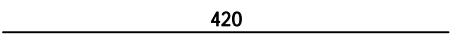
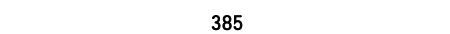
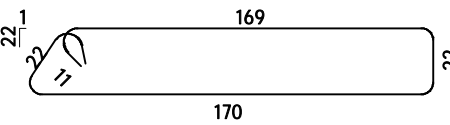
ISKAZ ARMATURE

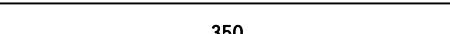
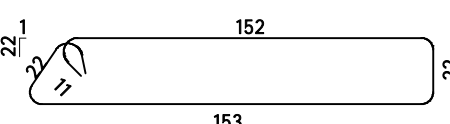
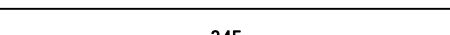
GRAĐEVINA:	REKONSTRUKCIJA TERMALNOG REKREACIJSKOG CENTRA TERME TUHELJ		
ISKAZ UZ NACRT:	ARM_E-2-312-314		
SADRŽAJ:	ARMATURA ZIDOVA E-1		
DATUM:	srpanj, 2023.	4/12	

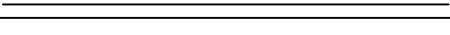
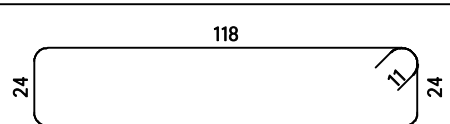
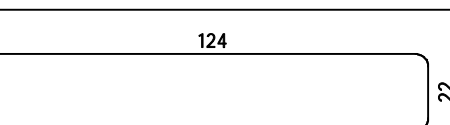
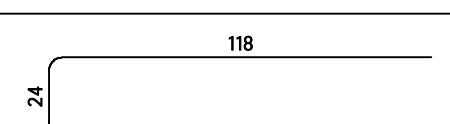
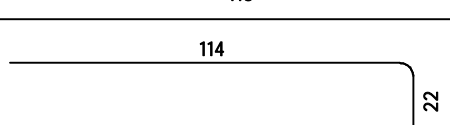
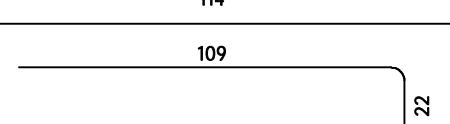
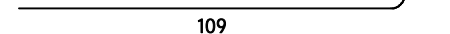
Šipke - specifikacija						
ozn	oblik i mjere [cm]	Ø	lg [m]	n [kom]	lgn [m]	Napomena
552	 430	10	4.30	2	8.60	
553	 425	10	4.25	44	187.00	
554	 420	10	4.20	78	327.60	
555	 385	10	3.85	2	7.70	
556	 169 22 170	10	4.05	8	32.40	
557	 375	10	3.75	10	37.50	
558	 350	10	3.50	28	98.00	
559	 152 22 153	10	3.71	11	40.81	
560	 345	10	3.45	10	34.50	
561	 290	10	2.90	4	11.60	
562	 285	10	2.85	4	11.40	
563	 118 24 118	10	3.06	26	79.56	
564	 124 22 124	10	2.70	7	18.90	
565	 118 24 118	10	2.60	16	41.60	
566	 114 22 114	10	2.50	8	20.00	
567	 109 22 109	10	2.40	15	36.00	
568	 230	10	2.30	2	4.60	

ISKAZ ARMATURE

GRAĐEVINA:	REKONSTRUKCIJA TERMALNOG REKREACIJSKOG CENTRA TERME TUHELJ	
ISKAZ UZ NACRT:	ARM_E-2-312-314	
SADRŽAJ:	ARMATURA ZIDOVA E-1	
DATUM:	srpanj, 2023.	5/12

Šipke - specifikacija						
ozn	oblik i mjere [cm]	Ø	lg [m]	n [kom]	lgn [m]	Napomena
569	<p>99. 22 99.</p>	10	2.20	165	363.00	
570	<p>93 24 93</p>	10	2.10	2	4.20	
571	<p>22 1 22 11 82 22 83</p>	10	2.31	1	2.31	
572	<p>22 1 22 11 80 22 81</p>	10	2.27	11	24.97	
573	<p>200</p>	10	2.00	21	42.00	
574	<p>17 3 17 73 17 76</p>	10	2.05	13	26.65	
575	<p>72 19 11 19 1 71</p>	10	2.03	17	34.51	
576	<p>78 24 78</p>	10	1.80	129	232.20	
577	<p>78 22 78</p>	10	1.78	110	195.80	
578	<p>44 44 44</p>	10	1.98	32	63.36	

ISKAZ ARMATURE

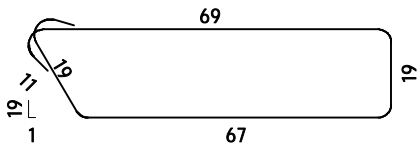
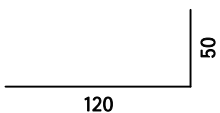
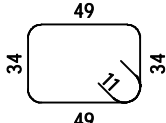
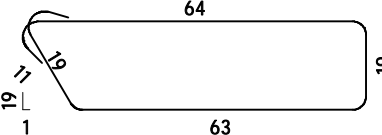
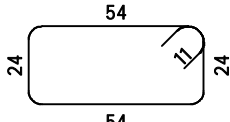
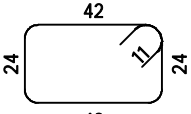
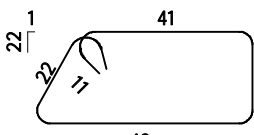
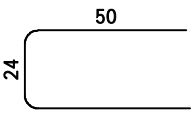
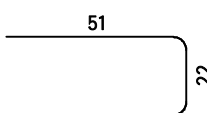
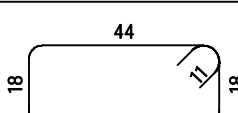

GRAĐEVINA:	REKONSTRUKCIJA TERMALNOG REKREACIJSKOG CENTRA TERME TUHELJ	
ISKAZ UZ NACRT:	ARM_E-2-312-314	
SADRŽAJ:	ARMATURA ZIDOVA E-1	
DATUM:	srpanj, 2023.	6/12

Šipke - specifikacija

ozn	oblik i mjere [cm]	Ø	lg [m]	n [kom]	lgn [m]	Napomena
579		10	1.96	18	35.28	
580		10	1.70	8	13.60	
581		10	1.88	25	47.00	
582		10	1.87	18	33.66	
583		10	1.78	16	28.48	
584		10	1.54	17	26.18	
585		10	1.49	2	2.98	
586		10	1.25	197	246.25	
587		10	1.25	10	12.50	
588		10	1.46	64	93.44	

ISKAZ ARMATURE

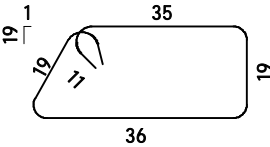
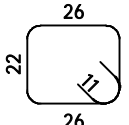
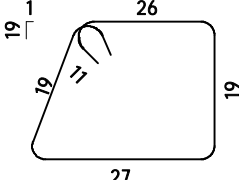
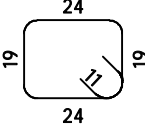
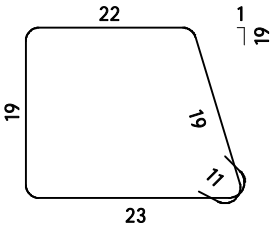
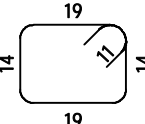
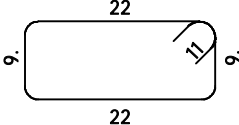
GRAĐEVINA:	REKONSTRUKCIJA TERMALNOG REKREACIJSKOG CENTRA TERME TUHELJ	
ISKAZ UZ NACRT:	ARM_E-2-312-314	
SADRŽAJ:	ARMATURA ZIDOVA E-1	
DATUM:	srpanj, 2023.	7/12

Šipke - specifikacija						
ozn	oblik i mjere [cm]	Ø	lg [m]	n [kom]	lgn [m]	Napomena
589		10	1.31	2	2.62	
590		10	1.18	3	3.54	
591		10	1.13	4	4.52	
592		10	1.08	6	6.48	
593		10	1.05	3	3.15	
594		10	0.88	3	2.64	
595		10	0.84	2	1.68	
596	840	8	8.40	2	16.80	
597	720	8	7.20	12	86.40	
598	410	8	4.10	6	24.60	
599		8	3.55	5	17.75	

ISKAZ ARMATURE

GRAĐEVINA:	REKONSTRUKCIJA TERMALNOG REKREACIJSKOG CENTRA TERME TUHELJ	
ISKAZ UZ NACRT:	ARM_E-2-312-314	
SADRŽAJ:	ARMATURA ZIDOVA E-1	
DATUM:	srpanj, 2023.	8/12

Šipke - specifikacija

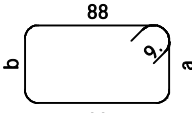
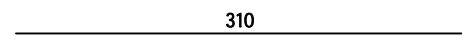
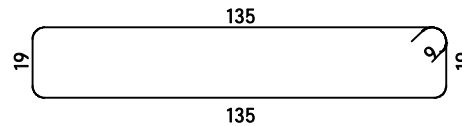
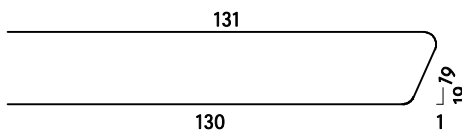
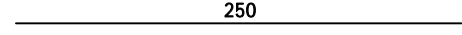
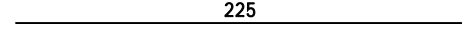
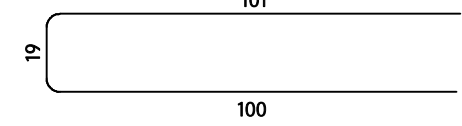
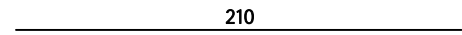
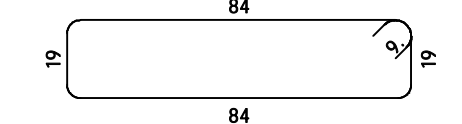
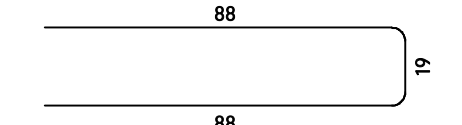
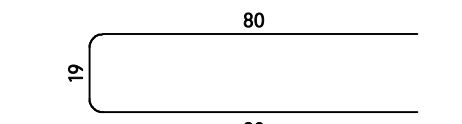
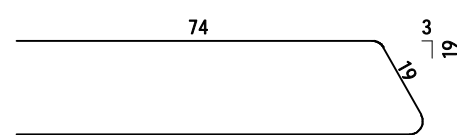
ozn	oblik i mjere [cm]	Ø	lg [m]	n [kom]	lgn [m]	Napomena
600	 <p>88 88</p> <p>a = 59, 58, 56, 55, 54, 53, 52, 51, 50, 49, 47, 46, 45, 44, 43, 42, 41, 40, 39, 37, 36 b = 59, 58, 56, 55, 54, 53, 52, 51, 50, 49, 47, 46, 45, 44, 43, 42, 41, 40, 39, 37, 36</p>	8	*2.89	1 x 21	60.68	
601	 <p>310</p>	8	3.10	2	6.20	
602	 <p>135 19</p>	8	3.26	2	6.52	
603	 <p>131 130</p>	8	2.80	24	67.20	
604	 <p>250</p>	8	2.50	8	20.00	
605	 <p>225</p>	8	2.25	2	4.50	
606	 <p>101 19</p>	8	2.20	2	4.40	
607	 <p>210</p>	8	2.10	2	4.20	
608	 <p>84 19</p>	8	2.24	28	62.72	
609	 <p>88 19</p>	8	1.95	16	31.20	
610	 <p>80 19</p>	8	1.79	263	470.77	
611	 <p>74 77</p>	8	1.70	20	34.00	

ISKAZ ARMATURE

GRAĐEVINA:	REKONSTRUKCIJA TERMALNOG REKREACIJSKOG CENTRA TERME TUHELJ	
ISKAZ UZ NACRT:	ARM_E-2-312-314	
SADRŽAJ:	ARMATURA ZIDOVA E-1	
DATUM:	srpanj, 2023.	9/12

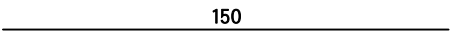
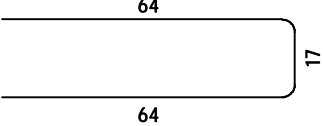
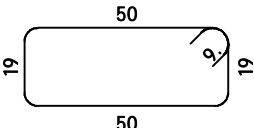
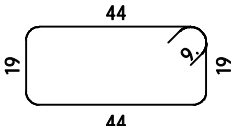
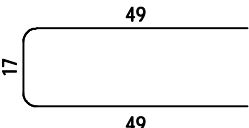
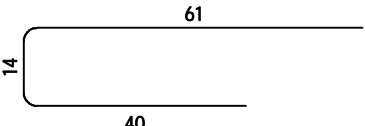
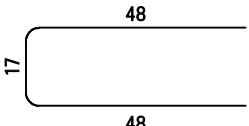
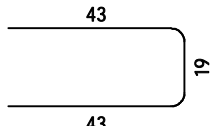
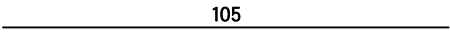
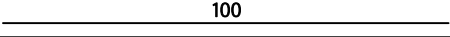
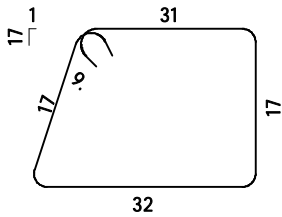
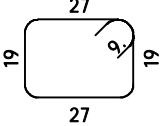
Šipke - specifikacija						
ozn	oblik i mjere [cm]	Ø	lg [m]	n [kom]	lgn [m]	Napomena
612		8	1.50	26	39.00	
613		8	1.45	111	160.95	
614		8	1.56	2	3.12	
615		8	1.44	3	4.32	
616		8	1.15	5	5.75	
617		8	1.15	21	24.15	
618		8	1.13	14	15.82	
619		8	1.05	9	9.45	
620		8	1.05	78	81.90	
621		8	1.00	16	16.00	
622		8	1.15	6	6.90	
623		8	1.10	16	17.60	

ISKAZ ARMATURE

GRAĐEVINA:	REKONSTRUKCIJA TERMALNOG REKREACIJSKOG CENTRA TERME TUHELJ	
ISKAZ UZ NACRT:	ARM_E-2-312-314	
SADRŽAJ:	ARMATURA ZIDOVA E-1	
DATUM:	srpanj, 2023.	10/12

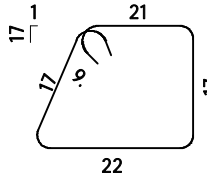
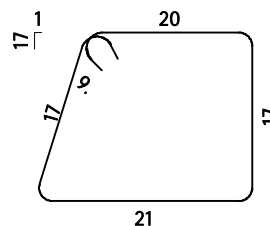
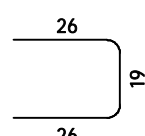
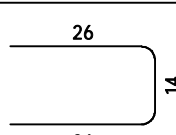
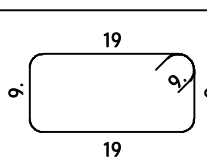
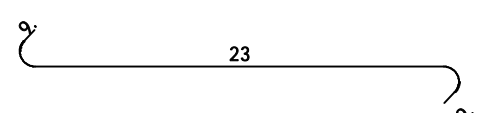
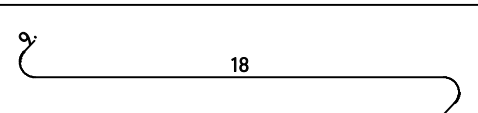
Šipke - specifikacija						
ozn	oblik i mjere [cm]	Ø	lg [m]	n [kom]	lgn [m]	Napomena
624		8	0.95	7	6.65	
625		8	0.93	3	2.79	
626		8	0.71	136	96.56	
627		8	0.66	106	69.96	
628		8	0.74	3	2.22	
629		8	0.41	272	111.52	
630		8	0.36	212	76.32	

ISKAZ ARMATURE		
GRAĐEVINA:	REKONSTRUKCIJA TERMALNOG REKREACIJSKOG CENTRA TERME TUHELJ	
ISKAZ UZ NACRT:	ARM_E-2-312-314	
SADRŽAJ:	ARMATURA ZIDOVA E-1	
DATUM:	srpanj, 2023.	11/12

Šipke - rekapitulacija			
Ø [mm]	lgn [m]	Jedinična težina [kg/m ¹]	Težina [kg]
B500B			
8	1668.92	0.40	659.22
10	3052.57	0.62	1883.44
12	0.00	0.89	0.00
14	904.79	1.21	1094.80
16	37.80	1.58	59.72
20	212.60	2.47	525.12
25	0.00	3.85	0.00
32	3.40	6.31	21.45
Ukupno (B500B)			4243.75
Ukupno			4243.75

ISKAZ ARMATURE		
GRAĐEVINA:	REKONSTRUKCIJA TERMALNOG REKREACIJSKOG CENTRA TERME TUHELJ	
ISKAZ UZ NACRT:	ARM_E-2-312-314	
SADRŽAJ:	ARMATURA ZIDOVA E-1	
DATUM:	srpanj, 2023.	12/12

Mreže - specifikacija							
Pozicija	Oznaka mreže	B [cm]	L [cm]	n	Jedinična težina [kg/m ²]	Ukupna težina [kg]	Napomena
Armatura zidova E-1 (1 kom)							
301-1	Q-335	215	408	2	5.38	94.34	
301-2	Q-335	145	396	2	5.38	61.79	
301-3	Q-335	215	271	8	5.38	250.77	
301-4	Q-335	210	409	2	5.38	92.45	
301-5	Q-335	170	410	2	5.38	75.06	
301-6	Q-335	204	413	2	5.38	90.63	
301-7	Q-335	140	170	2	5.38	25.65	
301-8	Q-335	215	302	2	5.38	69.85	
301-9	Q-335	215	314	2	5.38	72.64	
301-10	Q-335	215	326	2	5.38	75.43	
301-11	Q-335	215	416	2	5.38	96.14	
301-12	Q-335	146	404	2	5.38	63.36	
302-1	Q-524	215	324	1	8.31	57.89	
302-2	Q-524	215	324	1	8.31	57.89	
302-3	Q-524	215	324	1	8.31	57.89	
302-4	Q-524	215	391	1	8.31	69.84	
302-5	Q-524	116	396	1	8.31	38.15	
302-6	Q-524	215	367	2	8.31	131.01	
302-7	Q-524	215	355	2	8.31	126.80	
302-8	Q-524	101	343	2	8.31	57.59	
302-9	Q-524	215	394	2	8.31	140.73	
302-10	Q-524	195	391	2	8.31	126.76	
302-11	Q-524	134	315	2	8.31	70.15	
302-12	Q-524	215	336	2	8.31	120.09	
302-13	Q-524	215	333	2	8.31	119.13	
302-14	Q-524	89	331	2	8.31	48.91	
302-15	Q-524	169	382	2	8.31	107.25	
Ukupno						2398.22	

ISKAZ ARMATURE		
GRAĐEVINA:	REKONSTRUKCIJA TERMALNOG REKREACIJSKOG CENTRA TERME TUHELJ	
ISKAZ UZ NACRT:	ARM_E-2-312-314	
SADRŽAJ:	ARMATURA ZIDOVA E-2	
DATUM:	srpanj, 2023.	1/20

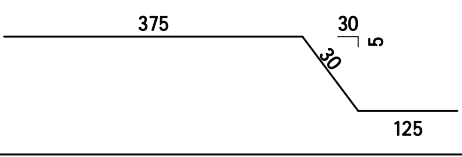
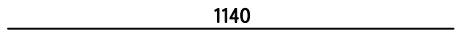
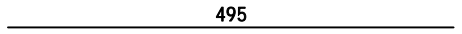
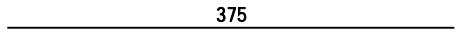
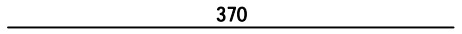
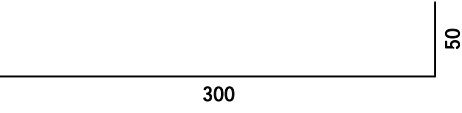
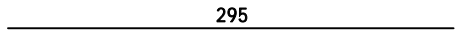
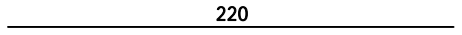
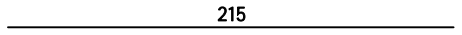
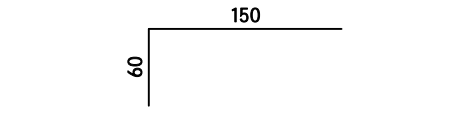
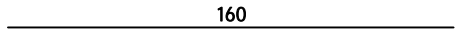
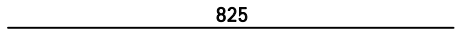
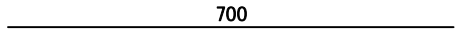
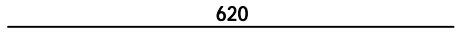
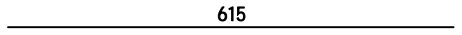
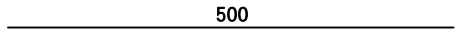
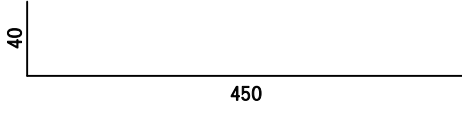
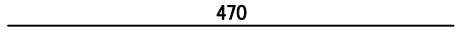
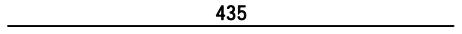
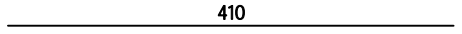
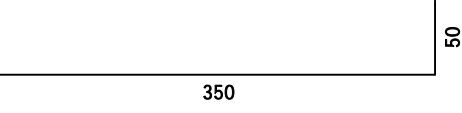
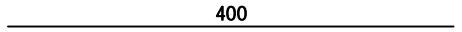

Šipke - specifikacija						
ozn	oblik i mjere [cm]	Ø	lg [m]	n [kom]	lgn [m]	Napomena
Armatura zidova E-2 (1 kom)						
201		20	5.30	21	111.30	
202		16	11.40	4	45.60	
203		16	4.95	12	59.40	
204		16	3.75	8	30.00	
205		16	3.70	8	29.60	
206		16	3.50	4	14.00	
207		16	2.95	4	11.80	
208		16	2.20	26	57.20	
209		16	2.15	4	8.60	
210		16	2.10	6	12.60	
211		16	1.60	4	6.40	
212		14	8.25	10	82.50	
213		14	7.00	2	14.00	
214		14	6.20	4	24.80	
215		14	6.15	4	24.60	
216		14	5.00	8	40.00	
217		14	4.90	4	19.60	
218		14	4.70	28	131.60	
219		14	4.35	28	121.80	
220		14	4.10	12	49.20	
221		14	4.00	8	32.00	
222		14	4.00	8	32.00	

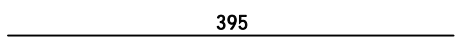
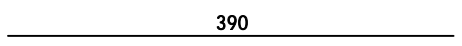
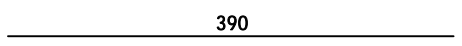
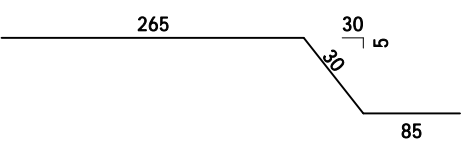
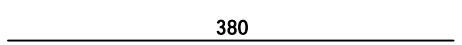
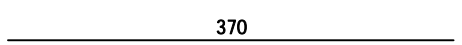
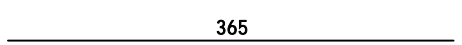
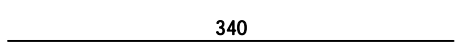
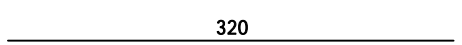
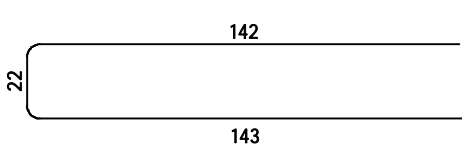
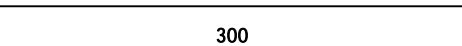
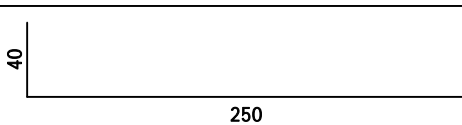
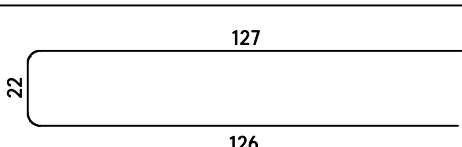
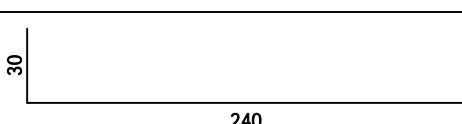
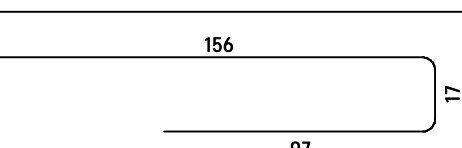
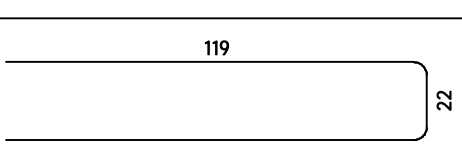
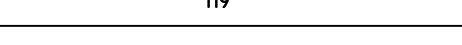
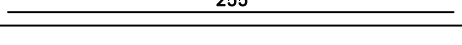
ISKAZ ARMATURE		
GRAĐEVINA:	REKONSTRUKCIJA TERMALNOG REKREACIJSKOG CENTRA TERME TUHELJ	
ISKAZ UZ NACRT:	ARM_E-2-312-314	
SADRŽAJ:	ARMATURA ZIDOVA E-2	
DATUM:	srpanj, 2023.	2/20

Šipke - specifikacija						
ozn	oblik i mjere [cm]	Ø	lg [m]	n [kom]	lgn [m]	Napomena
223		14	3.95	2	7.90	
224		14	3.90	34	132.60	
225		14	3.90	16	62.40	
226		14	3.80	4	15.20	
227		14	3.80	26	98.80	
228		14	3.70	16	59.20	
229		14	3.65	2	7.30	
230		14	3.40	4	13.60	
231		14	3.20	14	44.80	
232		14	3.07	4	12.28	
233		14	3.00	18	54.00	
234		14	2.90	8	23.20	
235		14	2.75	2	5.50	
236		14	2.70	2	5.40	
237		14	2.70	14	37.80	
238		14	2.60	2	5.20	
239		14	2.55	20	51.00	
240		14	2.60	4	10.40	

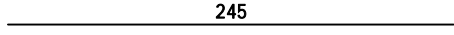
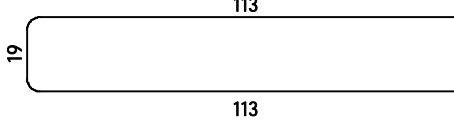
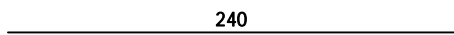
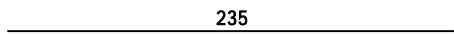
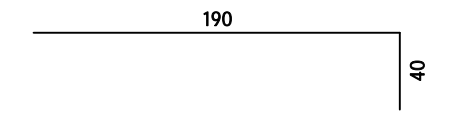
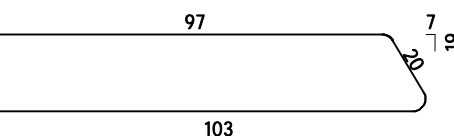
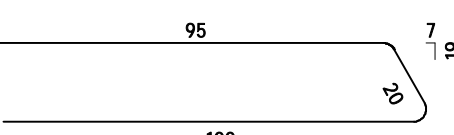
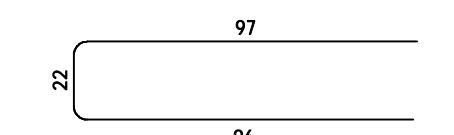
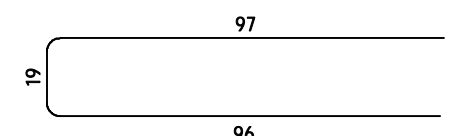
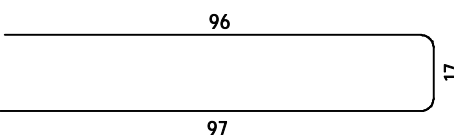
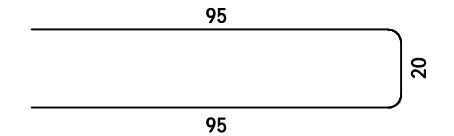
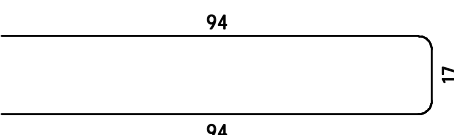

ISKAZ ARMATURE

GRAĐEVINA:	REKONSTRUKCIJA TERMALNOG REKREACIJSKOG CENTRA TERME TUHELJ	
ISKAZ UZ NACRT:	ARM_E-2-312-314	
SADRŽAJ:	ARMATURA ZIDOVA E-2	
DATUM:	srpanj, 2023.	3/20

Šipke - specifikacija						
ozn	oblik i mjere [cm]	Ø	lg [m]	n [kom]	lgn [m]	Napomena
241		14	2.45	8	19.60	
242		14	2.45	2	4.90	
243		14	2.40	4	9.60	
244		14	2.35	44	103.40	
245		14	2.30	4	9.20	
246		14	2.20	3	6.60	
247		14	2.15	3	6.45	
249		14	2.15	26	55.90	
250		14	2.12	20	42.40	
251		14	2.10	8	16.80	
252		14	2.10	2	4.20	
253		14	2.05	21	43.05	
254		14	2.00	8	16.00	

ISKAZ ARMATURE

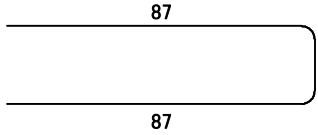
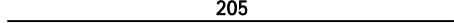
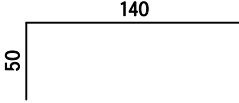
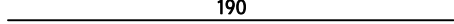
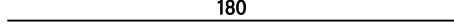
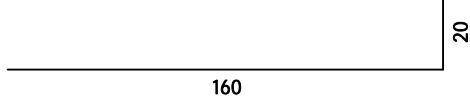
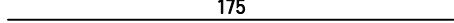
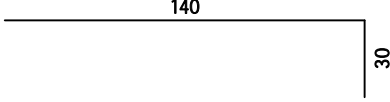
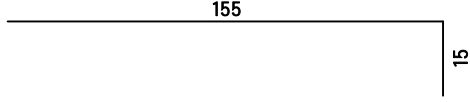
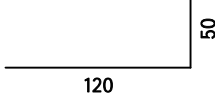
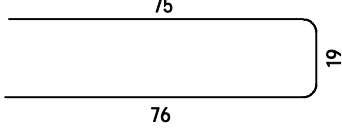
GRAĐEVINA:	REKONSTRUKCIJA TERMALNOG REKREACIJSKOG CENTRA TERME TUHELJ	
ISKAZ UZ NACRT:	ARM_E-2-312-314	
SADRŽAJ:	ARMATURA ZIDOVA E-2	
DATUM:	srpanj, 2023.	4/20

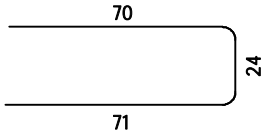
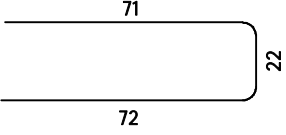
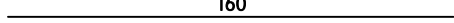
Šipke - specifikacija						
ozn	oblik i mjere [cm]	Ø	lg [m]	n [kom]	lgn [m]	Napomena
255		14	1.96	11	21.56	
256		14	2.05	8	16.40	
257		14	1.90	20	38.00	
258		14	1.90	4	7.60	
259		14	1.80	14	25.20	
260		14	1.80	14	25.20	
261		14	1.75	12	21.00	
262		14	1.70	4	6.80	
263		14	1.70	4	6.80	
264		14	1.70	8	13.60	
265		14	1.70	4	6.80	
266		14	1.70	12	20.40	
267		14	1.65	12	19.80	
268		14	1.65	2	3.30	
269		14	1.65	4	6.60	
270		14	1.60	22	35.20	

ISKAZ ARMATURE

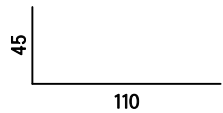
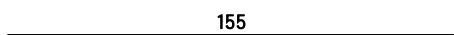
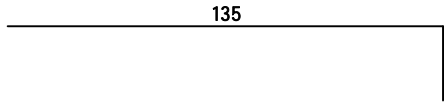
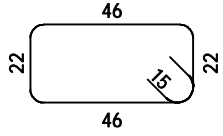
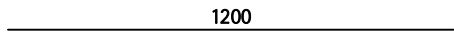
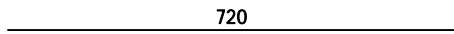
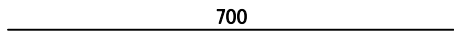
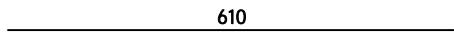
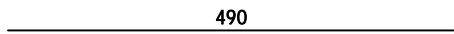
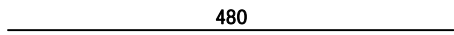
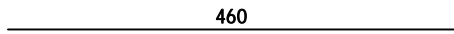
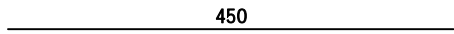
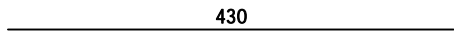
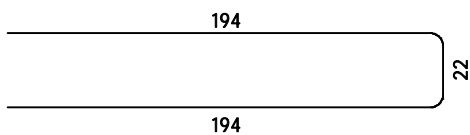
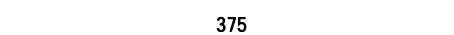
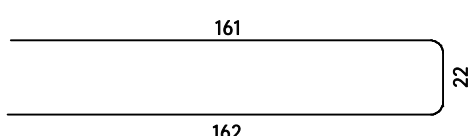
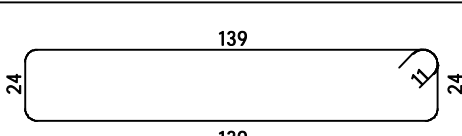
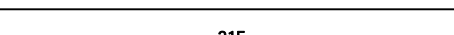

GRAĐEVINA:	REKONSTRUKCIJA TERMALNOG REKREACIJSKOG CENTRA TERME TUHELJ		
ISKAZ UZ NACRT:	ARM_E-2-312-314		
SADRŽAJ:	ARMATURA ZIDOVA E-2		
DATUM:	srpanj, 2023.	5/20	

Šipke - specifikacija

ozn	oblik i mjere [cm]	Ø	lg [m]	n [kom]	lgn [m]	Napomena
271		14	1.55	4	6.20	
272		14	1.55	8	12.40	
273		14	1.50	4	6.00	
274		14	1.66	5	8.30	
275		10	12.00	40	480.00	
276		10	7.20	6	43.20	
277		10	7.00	7	49.00	
278		10	6.10	4	24.40	
279		10	4.90	2	9.80	
280		10	4.80	22	105.60	
281		10	4.60	22	101.20	
282		10	4.50	38	171.00	
283		10	4.30	4	17.20	
284		10	4.10	5	20.50	
285		10	3.75	11	41.25	
286		10	3.45	41	141.45	
287		10	3.48	6	20.88	
288		10	3.15	8	25.20	

ISKAZ ARMATURE

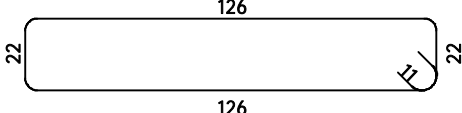
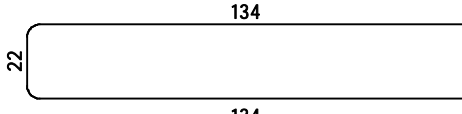
GRAĐEVINA:	REKONSTRUKCIJA TERMALNOG REKREACIJSKOG CENTRA TERME TUHELJ	
ISKAZ UZ NACRT:	ARM_E-2-312-314	
SADRŽAJ:	ARMATURA ZIDOVA E-2	
DATUM:	srpanj, 2023.	6/20

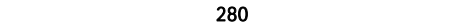
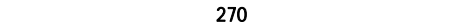
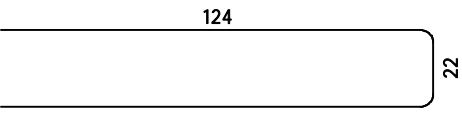
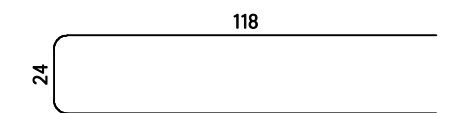
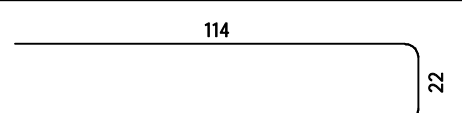
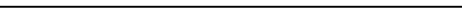
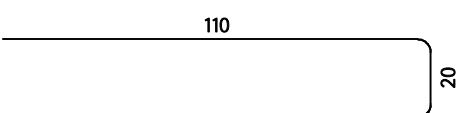
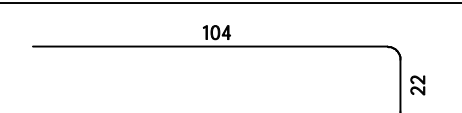
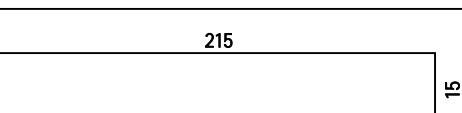
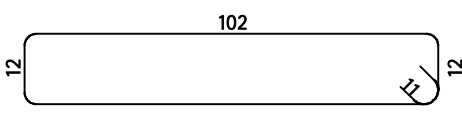
Šipke - specifikacija						
ozn	oblik i mjere [cm]	Ø	lg [m]	n [kom]	lgn [m]	Napomena
289		10	3.18	3	9.54	
290		10	2.90	3	8.70	
291		10	2.85	10	28.50	
292		10	2.80	52	145.60	
293		10	2.70	6	16.20	
294		10	2.70	14	37.80	
295		10	2.60	3	7.80	
296		10	2.50	3	7.50	
297		10	2.40	4	9.60	
298		10	2.40	9	21.60	
299		10	2.30	11	25.30	
300		10	2.30	10	23.00	
301		10	2.50	41	102.50	

ISKAZ ARMATURE

GRAĐEVINA:	REKONSTRUKCIJA TERMALNOG REKREACIJSKOG CENTRA TERME TUHELJ	
ISKAZ UZ NACRT:	ARM_E-2-312-314	
SADRŽAJ:	ARMATURA ZIDOVA E-2	
DATUM:	srpanj, 2023.	7/20

Šipke - specifikacija

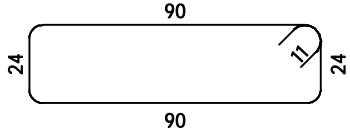
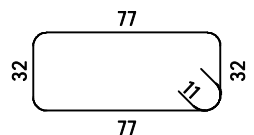
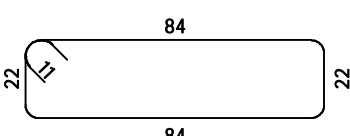
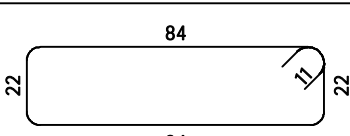
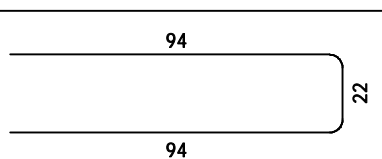
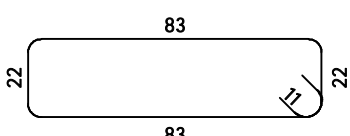
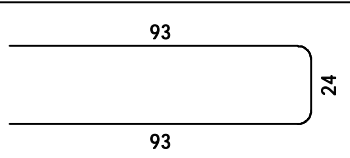
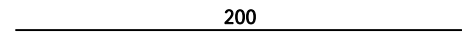
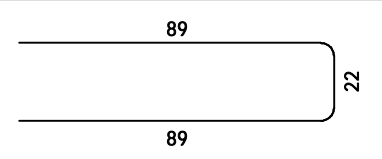
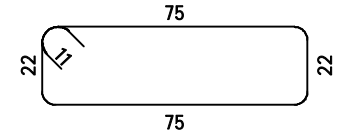
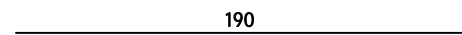
ozn	oblik i mjere [cm]	Ø	lg [m]	n [kom]	lgn [m]	Napomena
302		10	2.50	5	12.50	
303		10	2.40	41	98.40	
304		10	2.34	9	21.06	
305		10	2.34	5	11.70	
306		10	2.10	5	10.50	
307		10	2.32	9	20.88	
308		10	2.10	2	4.20	
309		10	2.00	40	80.00	
310		10	2.00	158	316.00	
311		10	2.16	11	23.76	
312		10	1.90	50	95.00	

ISKAZ ARMATURE

GRAĐEVINA:	REKONSTRUKCIJA TERMALNOG REKREACIJSKOG CENTRA TERME TUHELJ	
ISKAZ UZ NACRT:	ARM_E-2-312-314	
SADRŽAJ:	ARMATURA ZIDOVA E-2	
DATUM:	srpanj, 2023.	8/20

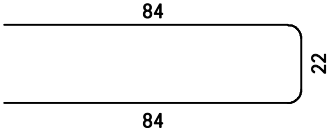
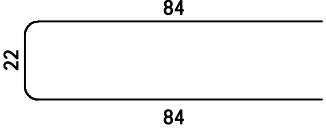
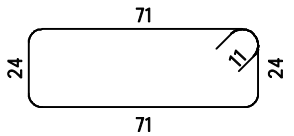
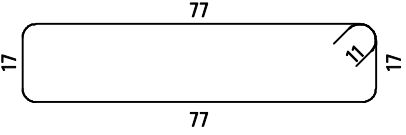
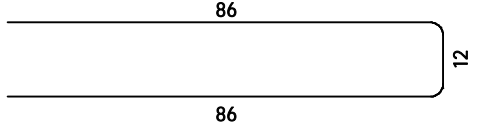
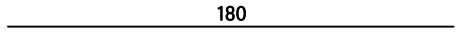
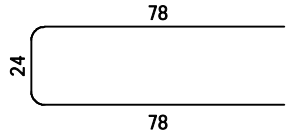
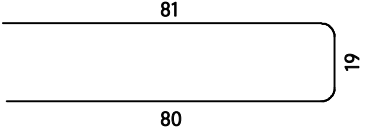
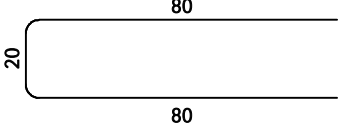
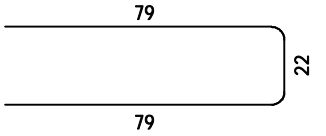
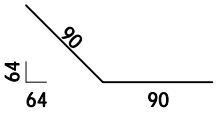

Šipke - specifikacija

ozn	oblik i mjere [cm]	Ø	lg [m]	n [kom]	lgn [m]	Napomena
313		10	1.90	4	7.60	
314		10	1.90	3	5.70	
315		10	2.12	3	6.36	
316		10	2.10	25	52.50	
317		10	1.84	4	7.36	
318		10	1.80	6	10.80	
319		10	1.80	131	235.80	
320		10	1.80	371	667.80	
321		10	1.80	184	331.20	
322		10	1.80	25	45.00	
323		10	1.80	46	82.80	

ISKAZ ARMATURE

GRAĐEVINA:	REKONSTRUKCIJA TERMALNOG REKREACIJSKOG CENTRA TERME TUHELJ	
ISKAZ UZ NACRT:	ARM_E-2-312-314	
SADRŽAJ:	ARMATURA ZIDOVA E-2	
DATUM:	srpanj, 2023.	9/20

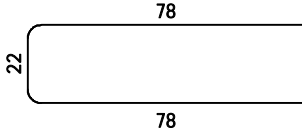
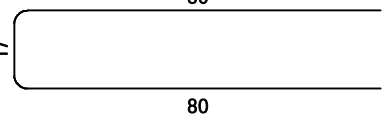
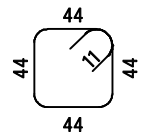
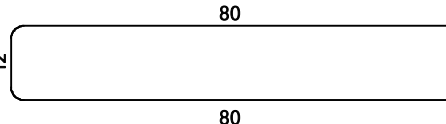
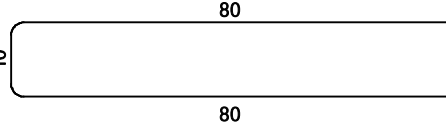
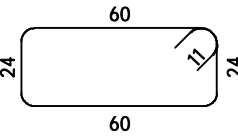
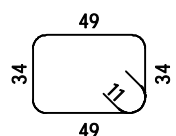
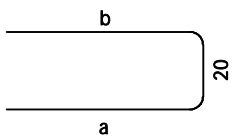
Šipke - specifikacija

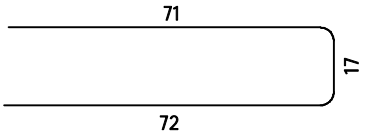
ozn	oblik i mjere [cm]	Ø	lg [m]	n [kom]	lgn [m]	Napomena
324		10	1.78	231	411.18	
325		10	1.77	78	138.06	
326		10	1.98	34	67.32	
327		10	1.72	58	99.76	
328		10	1.70	22	37.40	
329		10	1.90	4	7.60	
330		10	1.88	27	50.76	
331	 <p>a = 72, 66, 60, 54, 47, 41, 35, 29 b = 72, 66, 60, 54, 47, 41, 35, 29</p>	10	*1.21	1 x 8	9.68	
332		10	1.60	34	54.40	
333		10	1.60	5	8.00	

ISKAZ ARMATURE

GRAĐEVINA:	REKONSTRUKCIJA TERMALNOG REKREACIJSKOG CENTRA TERME TUHELJ	
ISKAZ UZ NACRT:	ARM_E-2-312-314	
SADRŽAJ:	ARMATURA ZIDOVA E-2	
DATUM:	srpanj, 2023.	10/20

Šipke - specifikacija						
ozn	oblik i mjere [cm]	Ø	lg [m]	n [kom]	lgn [m]	Napomena
334		10	1.60	15	24.00	
335		10	1.60	20	32.00	
336		10	1.55	46	71.30	
337		10	1.52	3	4.56	
338		10	1.52	6	9.12	
339		10	1.50	22	33.00	
340		10	1.47	12	17.64	
341		10	1.45	17	24.65	
342		10	1.40	3	4.20	
343		10	1.40	42	58.80	
344		10	1.40	8	11.20	
345		10	1.40	42	58.80	

ISKAZ ARMATURE

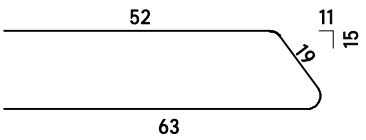
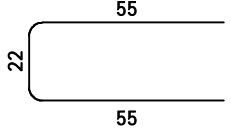
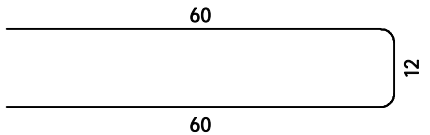
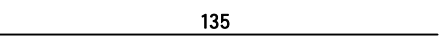
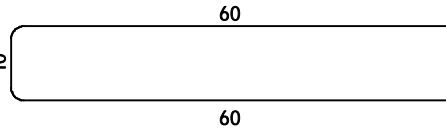
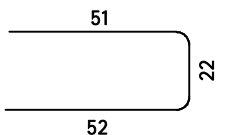
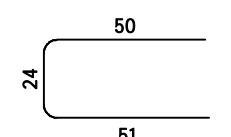
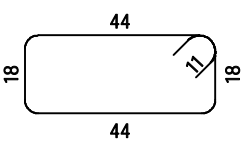
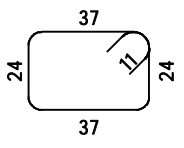
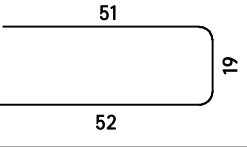
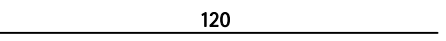

GRAĐEVINA:	REKONSTRUKCIJA TERMALNOG REKREACIJSKOG CENTRA TERME TUHELJ	
ISKAZ UZ NACRT:	ARM_E-2-312-314	
SADRŽAJ:	ARMATURA ZIDOVA E-2	
DATUM:	srpanj, 2023.	11/20

Šipke - specifikacija						
ozn	oblik i mjere [cm]	Ø	lg [m]	n [kom]	lgn [m]	Napomena
346		10	1.34	20	26.80	
347		10	1.32	5	6.60	
348		10	1.32	3	3.96	
349		10	1.35	1086	1466.10	
350		10	1.30	15	19.50	
351		10	1.25	68	85.00	
352		10	1.25	141	176.25	
353		10	1.46	68	99.28	
354		10	1.44	5	7.20	
355		10	1.22	8	9.76	
356		10	1.20	74	88.80	

ISKAZ ARMATURE

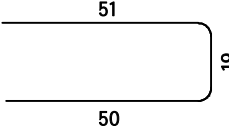
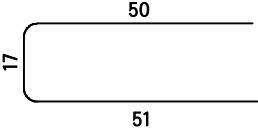
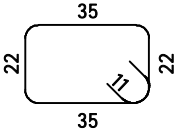
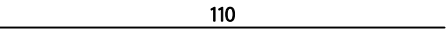
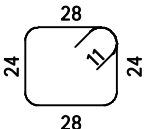
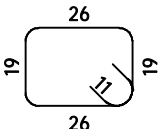
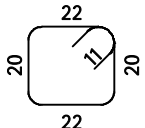
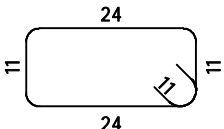
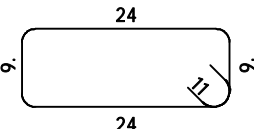
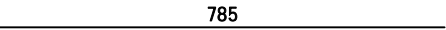
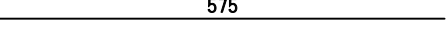
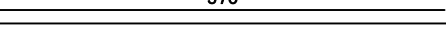
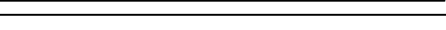
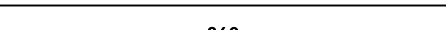

GRAĐEVINA:	REKONSTRUKCIJA TERMALNOG REKREACIJSKOG CENTRA TERME TUHELJ	
ISKAZ UZ NACRT:	ARM_E-2-312-314	
SADRŽAJ:	ARMATURA ZIDOVA E-2	
DATUM:	srpanj, 2023.	12/20

Šipke - specifikacija

ozn	oblik i mjere [cm]	Ø	lg [m]	n [kom]	lgn [m]	Napomena
357		10	1.20	16	19.20	
358		10	1.18	27	31.86	
359		10	1.36	5	6.80	
360		10	1.10	168	184.80	
361		10	1.26	5	6.30	
362		10	1.12	6	6.72	
363		10	1.06	2	2.12	
364		10	0.92	3	2.76	
365		10	0.88	5	4.40	
366		8	7.85	8	62.80	
367		8	5.75	4	23.00	
368		8	5.70	6	34.20	
369		8	4.70	32	150.40	
370		8	4.35	36	156.60	
371		8	3.60	10	36.00	

ISKAZ ARMATURE

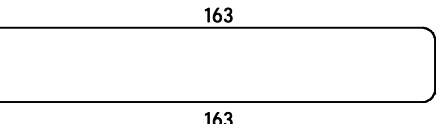
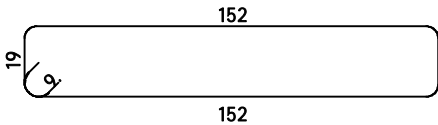
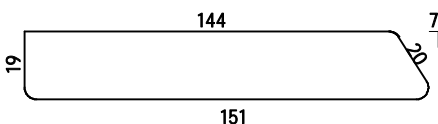
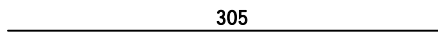
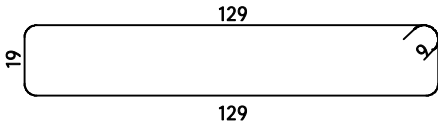
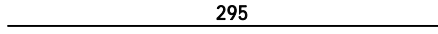
GRAĐEVINA:	REKONSTRUKCIJA TERMALNOG REKREACIJSKOG CENTRA TERME TUHELJ	
ISKAZ UZ NACRT:	ARM_E-2-312-314	
SADRŽAJ:	ARMATURA ZIDOVA E-2	
DATUM:	srpanj, 2023.	13/20

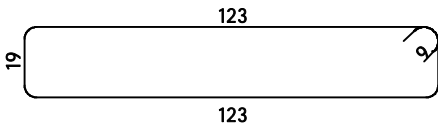
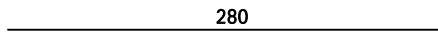
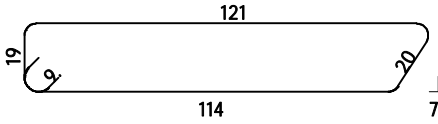
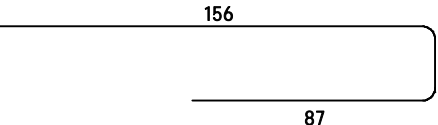
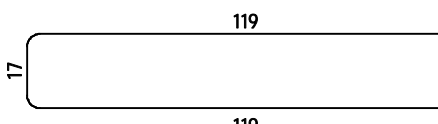
Šipke - specifikacija						
ozn	oblik i mjere [cm]	Ø	lg [m]	n [kom]	lgn [m]	Napomena
372		8	3.45	7	24.15	
373		8	3.60	17	61.20	
374		8	3.34	3	10.02	
375		8	3.05	6	18.30	
376		8	3.14	17	53.38	
377		8	2.95	6	17.70	
378		8	2.85	34	96.90	
379		8	3.02	4	12.08	
380		8	2.80	2	5.60	
381		8	2.92	17	49.64	
382		8	2.60	30	78.00	
383		8	2.55	15	38.25	

ISKAZ ARMATURE

GRAĐEVINA:	REKONSTRUKCIJA TERMALNOG REKREACIJSKOG CENTRA TERME TUHELJ	
ISKAZ UZ NACRT:	ARM_E-2-312-314	
SADRŽAJ:	ARMATURA ZIDOVA E-2	
DATUM:	srpanj, 2023.	14/20

Šipke - specifikacija						
ozn	oblik i mjere [cm]	Ø	lg [m]	n [kom]	lgn [m]	Napomena
384		8	2.70	17	45.90	
385		8	2.62	6	15.72	
386		8	2.40	12	28.80	
387		8	2.25	14	31.50	
388		8	2.20	6	13.20	
389		8	2.20	11	24.20	
390		8	2.28	17	38.76	
391		8	2.24	20	44.80	
392		8	2.20	4	8.80	
393		8	2.02	4	8.08	
394		8	1.80	18	32.40	
395		8	1.79	161	288.19	

ISKAZ ARMATURE

GRAĐEVINA:	REKONSTRUKCIJA TERMALNOG REKREACIJSKOG CENTRA TERME TUHELJ	
ISKAZ UZ NACRT:	ARM_E-2-312-314	
SADRŽAJ:	ARMATURA ZIDOVA E-2	
DATUM:	srpanj, 2023.	15/20

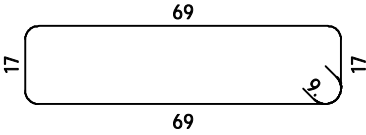
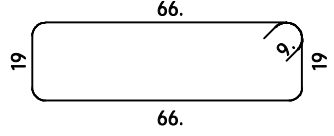
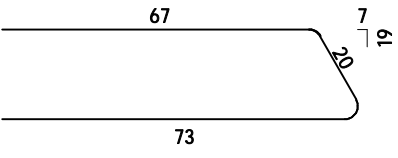
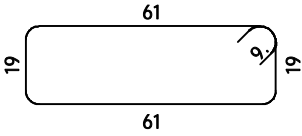
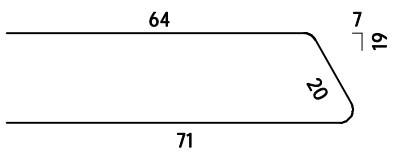
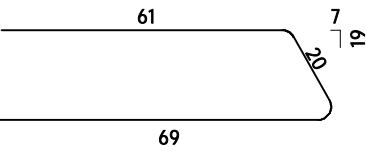
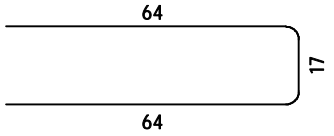
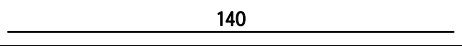
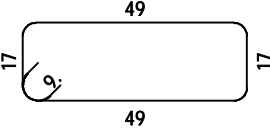
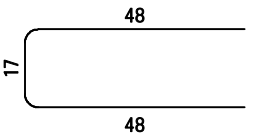
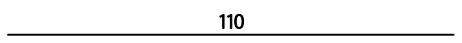
Šipke - specifikacija						
ozn	oblik i mjere [cm]	Ø	lg [m]	n [kom]	lgn [m]	Napomena
396		8	1.90	8	15.20	
397		8	1.88	3	5.64	
398		8	1.60	4	6.40	
399		8	1.78	19	33.82	
400		8	1.56	9	14.04	
401		8	1.50	4	6.00	
402		8	1.45	36	52.20	
403		8	1.40	4	5.60	
404		8	1.50	18	27.00	
405		8	1.13	40	45.20	
406		8	1.10	126	138.60	

ISKAZ ARMATURE

GRAĐEVINA:	REKONSTRUKCIJA TERMALNOG REKREACIJSKOG CENTRA TERME TUHELJ	
ISKAZ UZ NACRT:	ARM_E-2-312-314	
SADRŽAJ:	ARMATURA ZIDOVA E-2	
DATUM:	srpanj, 2023.	16/20

Šipke - specifikacija

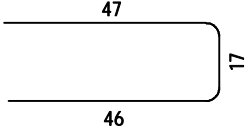
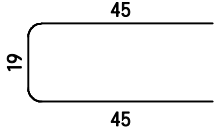
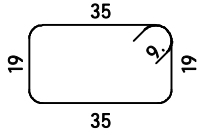
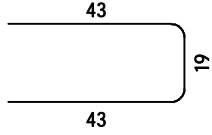
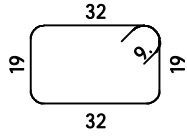
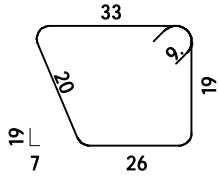
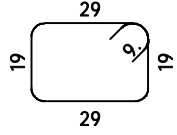
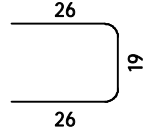
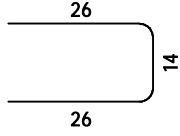
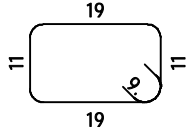
ozn	oblik i mjere [cm]	Ø	lg [m]	n [kom]	lgn [m]	Napomena
407		8	1.10	11	12.10	
408		8	1.09	20	21.80	
409		8	1.26	15	18.90	
410		8	1.05	98	102.90	
411		8	1.20	16	19.20	
412		8	1.16	4	4.64	
413		8	1.14	20	22.80	
414		8	0.71	398	282.58	
415		8	0.66	262	172.92	
416		8	0.78	3	2.34	

ISKAZ ARMATURE

GRAĐEVINA:	REKONSTRUKCIJA TERMALNOG REKREACIJSKOG CENTRA TERME TUHELJ	
ISKAZ UZ NACRT:	ARM_E-2-312-314	
SADRŽAJ:	ARMATURA ZIDOVA E-2	
DATUM:	srpanj, 2023.	17/20

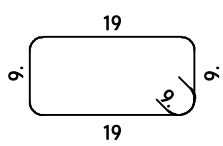
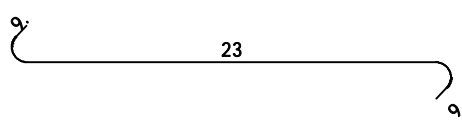
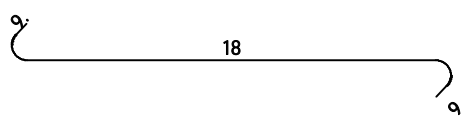
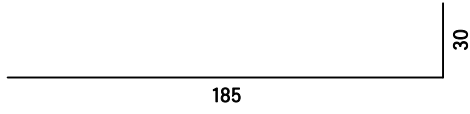
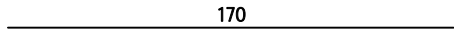
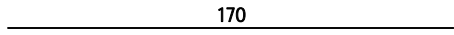
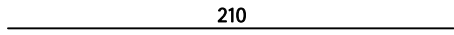
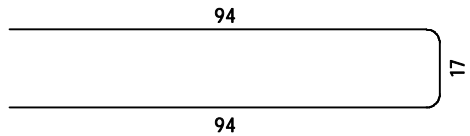
Šipke - specifikacija						
ozn	oblik i mjere [cm]	Ø	lg [m]	n [kom]	lgn [m]	Napomena
417		8	0.74	6	4.44	
418		8	0.41	796	326.36	
419		8	0.36	524	188.64	
420		16	2.15	4	8.60	
421		14	1.70	8	13.60	
422		14	1.70	40	68.00	
423		14	2.10	4	8.40	
424		16	2.05	1	2.05	

ISKAZ ARMATURE		
GRAĐEVINA:	REKONSTRUKCIJA TERMALNOG REKREACIJSKOG CENTRA TERME TUHELJ	
ISKAZ UZ NACRT:	ARM_E-2-312-314	
SADRŽAJ:	ARMATURA ZIDOVA E-2	
DATUM:	srpanj, 2023.	18/20

Šipke - rekapitulacija			
Ø [mm]	lgn [m]	Jedinična težina [kg/m ³]	Težina [kg]
B500B			
8	3037.89	0.40	1199.97
10	7328.88	0.62	4521.92
12	0.00	0.89	0.00
14	1953.94	1.21	2364.27
16	285.85	1.58	451.64
20	111.30	2.47	274.91
25	0.00	3.85	0.00
32	0.00	6.31	0.00
Ukupno (B500B)			8812.71
Ukupno			8812.71





ISKAZ ARMATURE		
GRAĐEVINA:	REKONSTRUKCIJA TERMALNOG REKREACIJSKOG CENTRA TERME TUHELJ	
ISKAZ UZ NACRT:	ARM_E-2-312-314	
SADRŽAJ:	ARMATURA ZIDOVA E-2	
DATUM:	srpanj, 2023.	19/20

Mreže - specifikacija							
Pozicija	Oznaka mreže	B [cm]	L [cm]	n	Jedinična težina [kg/m ²]	Ukupna težina [kg]	Napomena
Armatura zidova E-2 (1 kom)							
201-1	Q-524	170	600	24	8.31	2034.29	
201-2	Q-524	170	205	2	8.31	57.92	
201-3	Q-524	170	180	2	8.31	50.86	
201-4	Q-524	160	600	6	8.31	478.66	
201-5	Q-524	160	292	2	8.31	77.74	
201-6	Q-524	170	318	2	8.31	89.80	
201-7	Q-524	170	345	2	8.31	97.48	
201-8	Q-524	170	426	2	8.31	120.48	
201-9	Q-524	170	78	2	8.31	22.03	
201-10	Q-524	215	265	2	8.31	94.72	
201-11	Q-524	215	225	2	8.31	80.44	
201-12	Q-524	135	180	2	8.31	40.44	
201-13	Q-524	138	600	2	8.31	137.61	
201-14	Q-524	138	466	2	8.31	106.89	
201-15	Q-524	160	466	2	8.31	123.93	
201-16	Q-524	160	242	2	8.31	64.39	
201-17	Q-524	77	160	2	8.31	20.42	
201-18	Q-524	138	242	2	8.31	55.54	
201-19	Q-524	215	295	20	8.31	1054.12	
201-20	Q-524	75	295	2	8.31	36.77	
201-21	Q-524	169	295	2	8.31	82.86	
201-22	Q-524	170	371	2	8.31	104.82	
201-23	Q-524	85	371	2	8.31	52.41	
201-24	Q-524	215	295	6	8.31	316.24	
201-25	Q-524	154	295	2	8.31	75.50	
201-26	Q-524	174	295	2	8.31	85.31	
201-27	Q-524	170	261	2	8.31	73.74	
201-28	Q-524	215	329	2	8.31	117.56	
201-29	Q-524	215	397	2	8.31	141.86	
201-30	Q-524	215	405	2	8.31	144.72	
201-31	Q-524	131	405	2	8.31	87.95	
201-32	Q-524	195	553	2	8.31	179.06	
201-33	Q-524	215	314	6	8.31	336.60	
201-34	Q-524	201	295	2	8.31	98.69	
201-35	Q-524	215	374	24	8.31	1603.70	
201-36	Q-524	170	374	2	8.31	105.67	
201-37	Q-524	215	595	2	8.31	212.50	



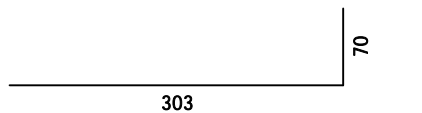
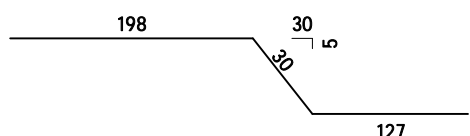
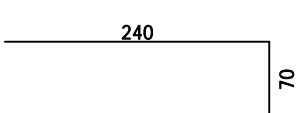
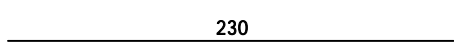
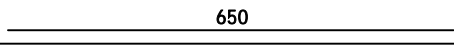
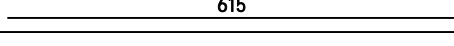
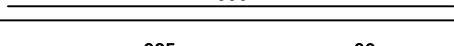
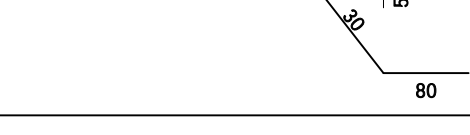
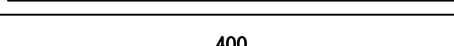
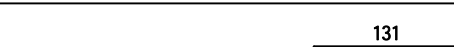
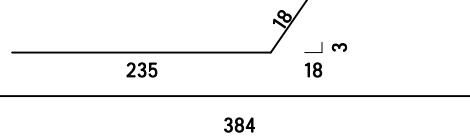

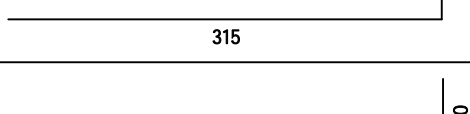
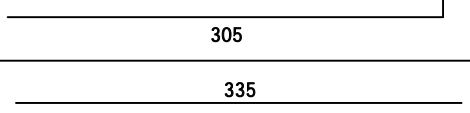

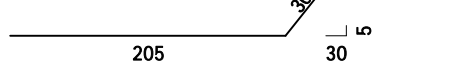
ISKAZ ARMATURE		
GRAĐEVINA:	REKONSTRUKCIJA TERMALNOG REKREACIJSKOG CENTRA TERME TUHELJ	
ISKAZ UZ NACRT:	ARM_E-2-312-314	
SADRŽAJ:	ARMATURA ZIDOVA E-2	
DATUM:	srpanj, 2023.	20/20

Mreže - specifikacija							
Pozicija	Oznaka mreže	B [cm]	L [cm]	n	Jedinična težina [kg/m ²]	Ukupna težina [kg]	Napomena
201-38	Q-524	117	374	2	8.31	72.88	
201-39	Q-524	160	170	2	8.31	45.21	
201-40	Q-524	163	538	2	8.31	146.12	
201-41	Q-524	170	497	2	8.31	140.42	
201-42	Q-524	215	212	2	8.31	75.84	
201-43	Q-524	215	224	2	8.31	80.21	
201-44	Q-524	215	221	2	8.31	78.99	
201-45	Q-524	90	173	2	8.31	25.84	
202-1	Q-335	215	285	4	5.38	131.86	
202-2	Q-335	145	285	2	5.38	44.47	
202-3	Q-335	215	321	4	5.38	148.52	
202-4	Q-335	90	321	2	5.38	31.09	
202-5	Q-335	199	405	2	5.38	86.94	
202-6	Q-335	209	405	2	5.38	91.07	
202-7	Q-335	159	285	2	5.38	48.76	
202-8	Q-335	215	295	2	5.38	68.25	
202-9	Q-335	145	295	2	5.38	46.03	
Ukupno						10026.21	

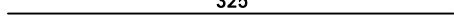
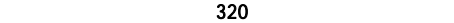
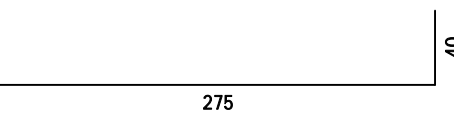
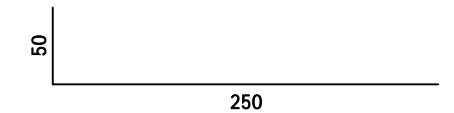
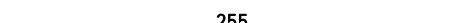
ISKAZ ARMATURE		
GRAĐEVINA:	REKONSTRUKCIJA TERMALNOG REKREACIJSKOG CENTRA TERME TUHELJ	
ISKAZ UZ NACRT:	ARM_E-2-312-314	
SADRŽAJ:	ARMATURA ZIDOVA E-3	
DATUM:	srpanj, 2023.	1/11

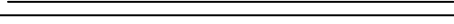
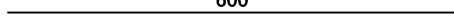

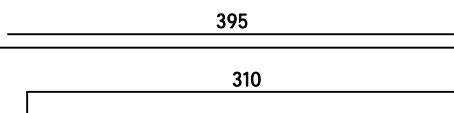
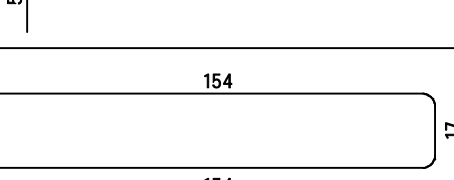
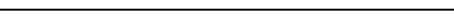
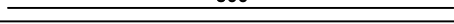
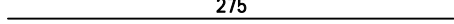
Šipke - specifikacija						
ozn	oblik i mjere [cm]	Ø	lg [m]	n [kom]	lgn [m]	Napomena
Armatura zidova E-3 (1 kom)						
1		25	3.73	14	52.22	
2		20	3.55	10	35.50	
3		20	3.10	4	12.40	
4		20	2.30	15	34.50	
5		16	6.50	6	39.00	
6		16	6.15	16	98.40	
7		16	6.00	6	36.00	
8		16	4.05	2	8.10	
9		16	4.05	18	72.90	
10		16	4.00	12	48.00	
11		16	3.84	2	7.68	
12		16	3.84	2	7.68	
13		16	3.70	8	29.60	
14		16	3.45	5	17.25	
15		16	3.35	4	13.40	
16		16	3.25	2	6.50	

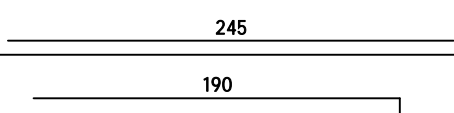
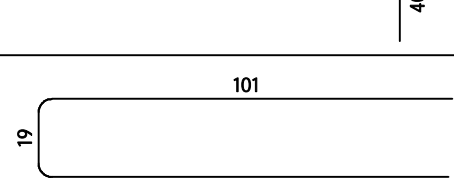
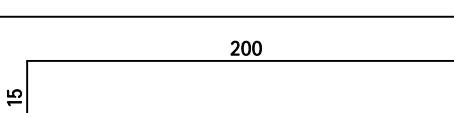
ISKAZ ARMATURE		
GRAĐEVINA:	REKONSTRUKCIJA TERMALNOG REKREACIJSKOG CENTRA TERME TUHELJ	
ISKAZ UZ NACRT:	ARM_E-2-312-314	
SADRŽAJ:	ARMATURA ZIDOVA E-3	
DATUM:	srpanj, 2023.	2/11

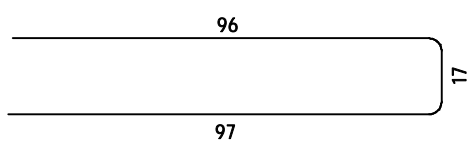
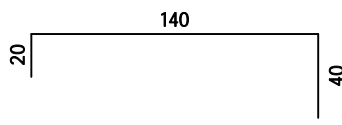
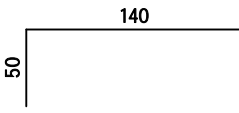
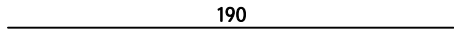
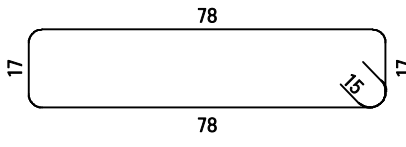
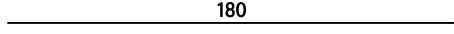
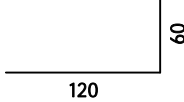
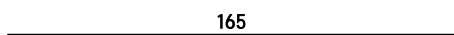
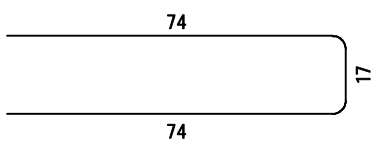

Šipke - specifikacija						
ozn	oblik i mjere [cm]	Ø	lg [m]	n [kom]	lgn [m]	Napomena
17		16	3.25	22	71.50	
18		16	3.20	4	12.80	
19		16	3.15	16	50.40	
20		16	3.00	4	12.00	
21		16	2.55	4	10.20	
22		14	6.15	4	24.60	
23		14	6.00	4	24.00	
24		14	5.00	4	20.00	
25		14	3.95	12	47.40	
26		14	3.60	4	14.40	
27		14	3.25	2	6.50	
28		14	3.00	8	24.00	
29		14	2.75	4	11.00	
30		14	2.50	4	10.00	
31		14	2.45	40	98.00	
32		14	2.30	8	18.40	
33		14	2.20	4	8.80	
34		14	2.15	4	8.60	

ISKAZ ARMATURE

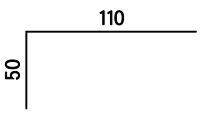
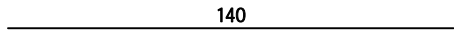
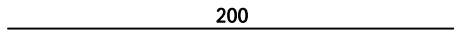
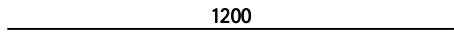
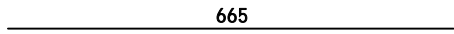
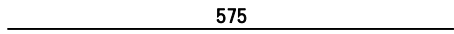
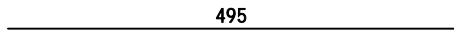
GRAĐEVINA:	REKONSTRUKCIJA TERMALNOG REKREACIJSKOG CENTRA TERME TUHELJ	
ISKAZ UZ NACRT:	ARM_E-2-312-314	
SADRŽAJ:	ARMATURA ZIDOVA E-3	
DATUM:	srpanj, 2023.	3/11

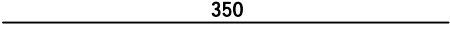
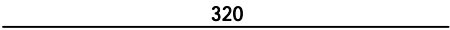
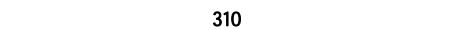

Šipke - specifikacija						
ozn	oblik i mjere [cm]	Ø	lg [m]	n [kom]	lgn [m]	Napomena
35		14	2.10	2	4.20	
36		14	2.00	4	8.00	
37		14	1.90	2	3.80	
38		14	1.90	4	7.60	
39		14	2.20	2	4.40	
40		14	1.80	2	3.60	
41		14	1.80	8	14.40	
42		14	1.65	28	46.20	
43		14	1.65	2	3.30	
44		14	1.61	8	12.88	
45		14	1.60	4	6.40	
46		14	1.40	8	11.20	
47		12	2.00	4	8.00	
48		10	12.00	4	48.00	
49		10	6.65	26	172.90	
50		10	5.75	16	92.00	
51		10	4.95	6	29.70	

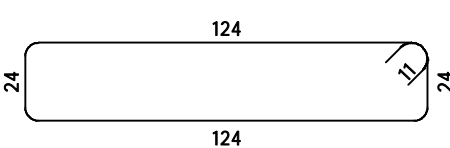
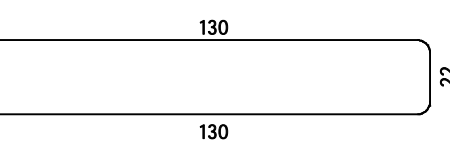
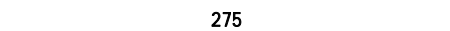
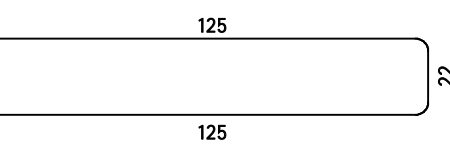
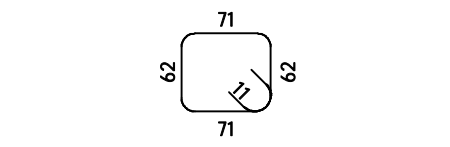
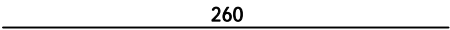
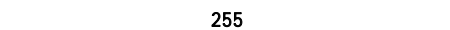
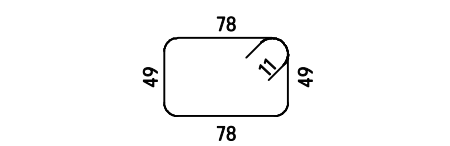
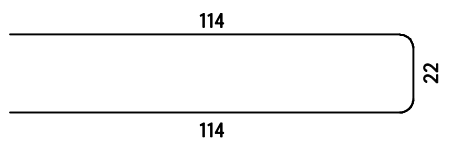
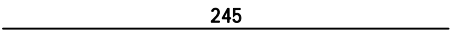
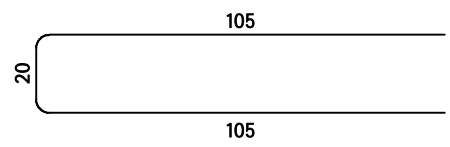
ISKAZ ARMATURE		
GRAĐEVINA:	REKONSTRUKCIJA TERMALNOG REKREACIJSKOG CENTRA TERME TUHELJ	
ISKAZ UZ NACRT:	ARM_E-2-312-314	
SADRŽAJ:	ARMATURA ZIDOVA E-3	
DATUM:	srpanj, 2023.	4/11

Šipke - specifikacija						
ozn	oblik i mjere [cm]	Ø	lg [m]	n [kom]	lgn [m]	Napomena
53		10	3.50	16	56.00	
54		10	3.20	10	32.00	
55		10	3.10	106	328.60	
56		10	3.00	8	24.00	
57		10	3.18	16	50.88	
58		10	2.82	2	5.64	
59		10	2.75	34	93.50	
60		10	2.72	12	32.64	
61		10	2.88	17	48.96	
62		10	2.60	8	20.80	
63		10	2.55	4	10.20	
64		10	2.76	16	44.16	
65		10	2.50	4	10.00	
66		10	2.45	10	24.50	
67		10	2.30	14	32.20	

ISKAZ ARMATURE

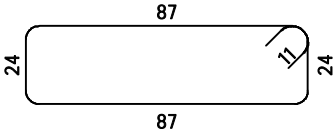
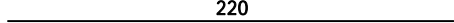
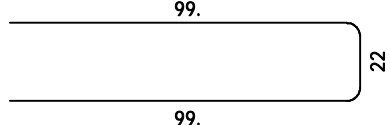
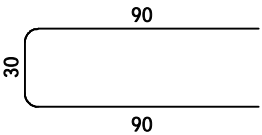
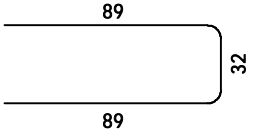
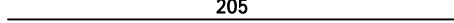
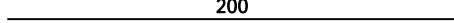
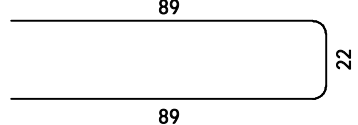
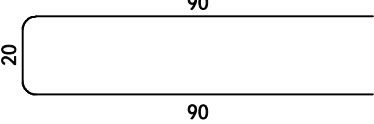
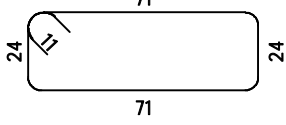
GRAĐEVINA:	REKONSTRUKCIJA TERMALNOG REKREACIJSKOG CENTRA TERME TUHELJ	
ISKAZ UZ NACRT:	ARM_E-2-312-314	
SADRŽAJ:	ARMATURA ZIDOVA E-3	
DATUM:	srpanj, 2023.	5/11

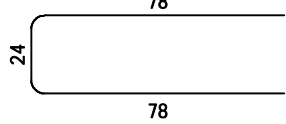
Šipke - specifikacija						
ozn	oblik i mjere [cm]	Ø	lg [m]	n [kom]	lgn [m]	Napomena
68		10	2.44	3	7.32	
69		10	2.20	4	8.80	
70		10	2.20	19	41.80	
71		10	2.10	100	210.00	
72		10	2.10	58	121.80	
73		10	2.05	24	49.20	
74		10	2.00	10	20.00	
75		10	2.00	73	146.00	
76		10	2.00	2	4.00	
77		10	2.12	17	36.04	
78		10	2.06	16	32.96	
79		10	1.80	70	126.00	

ISKAZ ARMATURE

GRAĐEVINA:	REKONSTRUKCIJA TERMALNOG REKREACIJSKOG CENTRA TERME TUHELJ	
ISKAZ UZ NACRT:	ARM_E-2-312-314	
SADRŽAJ:	ARMATURA ZIDOVA E-3	
DATUM:	srpanj, 2023.	6/11

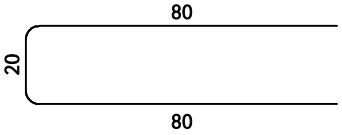
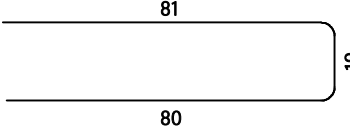
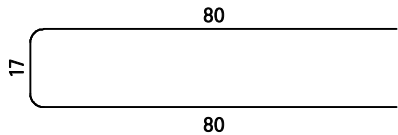
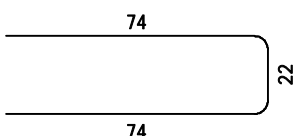
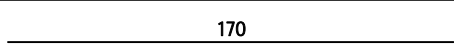
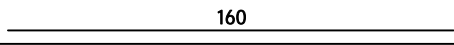
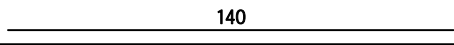
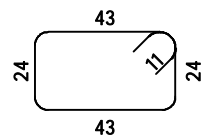
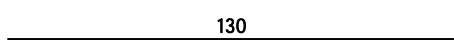
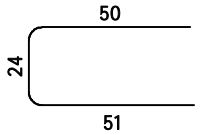
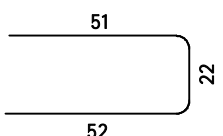
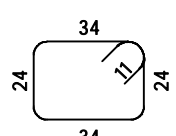
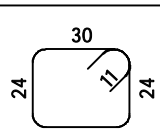
Šipke - specifikacija						
ozn	oblik i mjere [cm]	Ø	lg [m]	n [kom]	lgn [m]	Napomena
80		10	1.80	190	342.00	
81		10	1.80	12	21.60	
82		10	1.77	22	38.94	
83		10	1.70	88	149.60	
84		10	1.70	34	57.80	
85		10	1.60	6	9.60	
86		10	1.40	165	231.00	
87		10	1.56	3	4.68	
88		10	1.30	669	869.70	
89		10	1.25	62	77.50	
90		10	1.25	56	70.00	
91		10	1.38	2	2.76	
92		10	1.30	2	2.60	

ISKAZ ARMATURE

GRAĐEVINA:	REKONSTRUKCIJA TERMALNOG REKREACIJSKOG CENTRA TERME TUHELJ		
ISKAZ UZ NACRT:	ARM_E-2-312-314		
SADRŽAJ:	ARMATURA ZIDOVA E-3		
DATUM:	srpanj, 2023.	7/11	

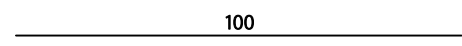
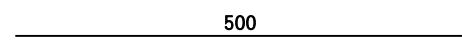
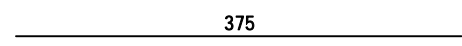
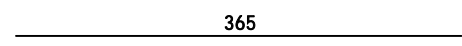
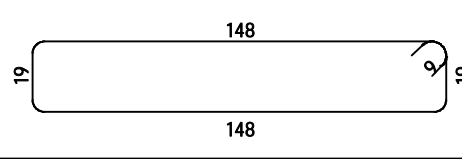
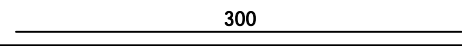
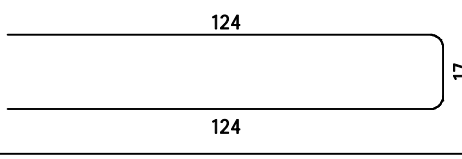
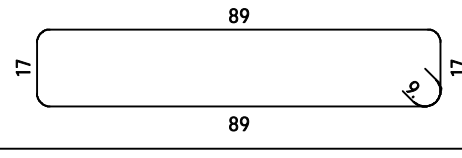
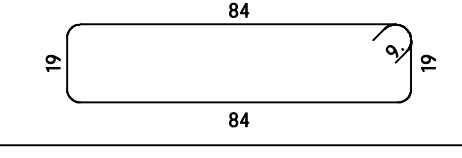
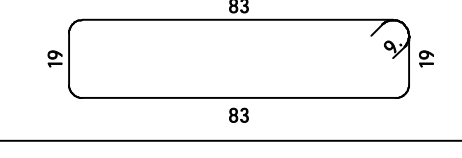
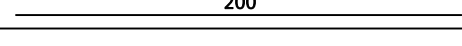
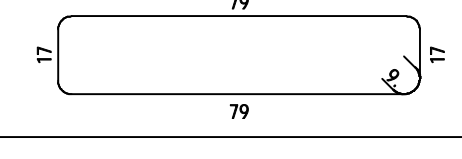
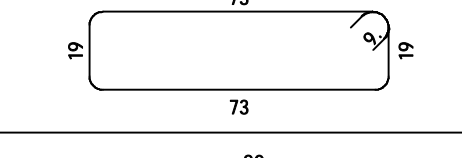
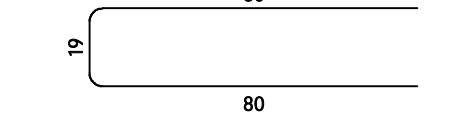
Šipke - specifikacija						
ozn	oblik i mjere [cm]	Ø	lg [m]	n [kom]	lgn [m]	Napomena
93		10	1.00	42	42.00	
94		8	5.00	3	15.00	
95		8	3.75	6	22.50	
96		8	3.65	12	43.80	
97		8	3.52	16	56.32	
98		8	3.00	6	18.00	
99		8	2.65	4	10.60	
100		8	2.30	8	18.40	
101		8	2.24	20	44.80	
102		8	2.22	19	42.18	
103		8	2.00	6	12.00	
104		8	2.10	6	12.60	
105		8	2.02	17	34.34	
106		8	1.79	45	80.55	

ISKAZ ARMATURE

GRAĐEVINA:	REKONSTRUKCIJA TERMALNOG REKREACIJSKOG CENTRA TERME TUHELJ	
ISKAZ UZ NACRT:	ARM_E-2-312-314	
SADRŽAJ:	ARMATURA ZIDOVA E-3	
DATUM:	srpanj, 2023.	8/11

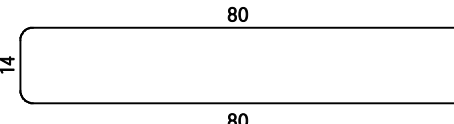
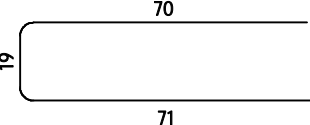
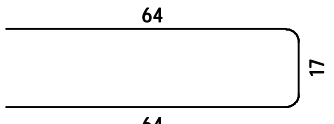
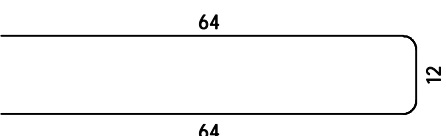
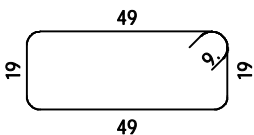
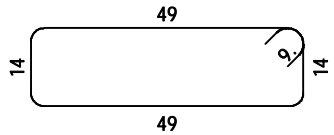
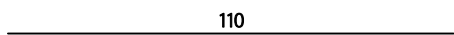
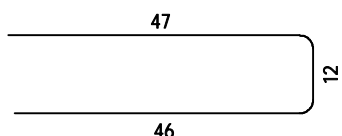
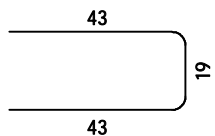
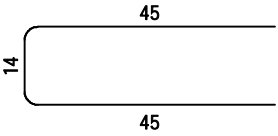
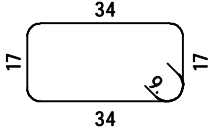
Šipke - specifikacija						
ozn	oblik i mjere [cm]	Ø	lg [m]	n [kom]	lgn [m]	Napomena
107		8	1.74	38	66.12	
108		8	1.60	3	4.80	
109		8	1.45	2	2.90	
110		8	1.40	14	19.60	
111		8	1.54	2	3.08	
112		8	1.44	2	2.88	
113		8	1.10	44	48.40	
114		8	1.05	15	15.75	
115		8	1.05	2	2.10	
116		8	1.04	18	18.72	
117		8	1.20	4	4.80	

ISKAZ ARMATURE

GRAĐEVINA:	REKONSTRUKCIJA TERMALNOG REKREACIJSKOG CENTRA TERME TUHELJ	
ISKAZ UZ NACRT:	ARM_E-2-312-314	
SADRŽAJ:	ARMATURA ZIDOVA E-3	
DATUM:	srpanj, 2023.	9/11

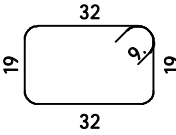
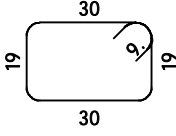
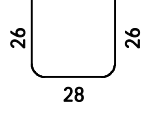
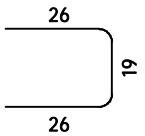
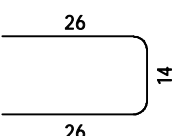
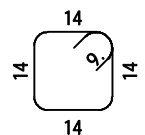
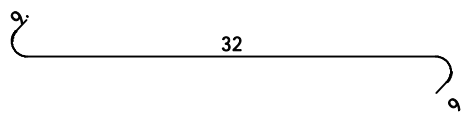
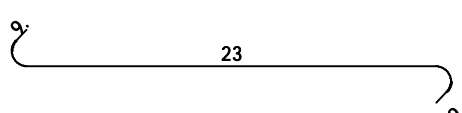
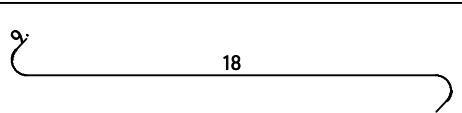
Šipke - specifikacija						
ozn	oblik i mjere [cm]	Ø	lg [m]	n [kom]	lgn [m]	Napomena
118		8	1.20	16	19.20	
119		8	1.16	14	16.24	
120		8	0.80	28	22.40	
121		8	0.71	188	133.48	
122		8	0.66	55	36.30	
123		8	0.74	2	1.48	
124		8	0.50	56	28.00	
125		8	0.41	376	154.16	
126		8	0.36	110	39.60	

ISKAZ ARMATURE		
GRAĐEVINA:	REKONSTRUKCIJA TERMALNOG REKREACIJSKOG CENTRA TERME TUHELJ	
ISKAZ UZ NACRT:	ARM_E-2-312-314	
SADRŽAJ:	ARMATURA ZIDOVA E-3	
DATUM:	srpanj, 2023.	10/11

Šipke - rekapitulacija			
Ø [mm]	lgn [m]	Jedinična težina [kg/m ¹]	Težina [kg]
B500B			
8	1051.10	0.40	415.18
10	3880.38	0.62	2394.19
12	8.00	0.89	7.10
14	441.68	1.21	534.43
16	541.41	1.58	855.43
20	82.40	2.47	203.53
25	52.22	3.85	201.05
32	0.00	6.31	0.00
Ukupno (B500B)			4610.92
Ukupno			4610.92

ISKAZ ARMATURE		
GRAĐEVINA:	REKONSTRUKCIJA TERMALNOG REKREACIJSKOG CENTRA TERME TUHELJ	
ISKAZ UZ NACRT:	ARM_E-2-312-314	
SADRŽAJ:	ARMATURA ZIDOVA E-3	
DATUM:	srpanj, 2023.	11/11

Mreže - specifikacija							
Pozicija	Oznaka mreže	B [cm]	L [cm]	n	Jedinična težina [kg/m2]	Ukupna težina [kg]	Napomena
Armatura zidova E-3 (1 kom)							
101-1	Q-524	147	600	8	8.31	586.35	
101-2	Q-524	147	245	2	8.31	59.86	
101-3	Q-524	215	272	2	8.31	97.34	
101-4	Q-524	215	228	2	8.31	81.30	
101-5	Q-524	135	183	2	8.31	40.98	
101-6	Q-524	215	517	14	8.31	1293.18	
101-7	Q-524	112	517	2	8.31	96.24	
101-8	Q-524	215	300	8	8.31	428.80	
101-9	Q-524	85	300	2	8.31	42.38	
101-10	Q-524	70	300	2	8.31	34.90	
101-11	Q-524	170	300	2	8.31	84.76	
101-12	Q-524	215	310	2	8.31	110.77	
101-13	Q-524	145	310	2	8.31	74.71	
101-14	Q-524	170	253	2	8.31	71.48	
101-15	Q-524	215	253	6	8.31	271.21	
101-16	Q-524	110	253	2	8.31	46.25	
101-17	Q-524	213	430	2	8.31	152.23	
101-18	Q-524	215	225	2	8.31	80.40	
101-19	Q-524	146	255	2	8.31	61.88	
101-20	Q-524	213	494	2	8.31	174.88	
101-21	Q-524	215	167	2	8.31	59.67	
101-22	Q-524	59	253	2	8.31	24.81	
101-23	Q-524	90	517	2	8.31	77.33	
101-24	Q-524	160	170	2	8.31	45.21	
101-25	Q-524	160	170	2	8.31	45.21	
101-26	Q-524	83	255	2	8.31	35.18	
101-27	Q-524	212	283	2	8.31	99.71	
102-1	Q-335	215	300	4	5.38	138.80	
102-2	Q-335	154	300	2	5.38	49.71	
102-3	Q-335	215	310	2	5.38	71.72	
102-4	Q-335	159	310	2	5.38	53.04	
Ukupno						4590.28	

NACRT ARMATURE STUPOVA DILATACIJE 3
M 1:50

ARMATURA STUPA 3.1,
M 1:50

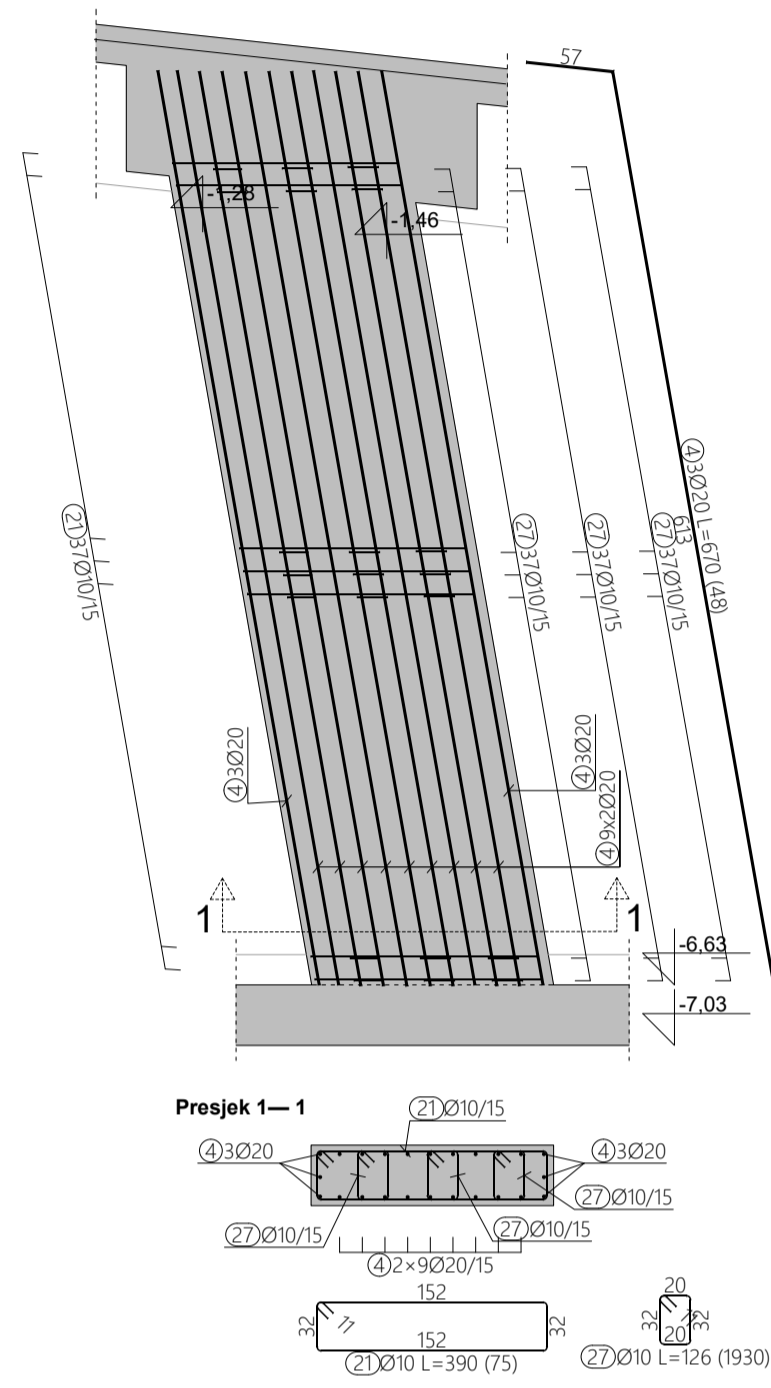

ARMATURA STUPA 3.2,
M 1:50

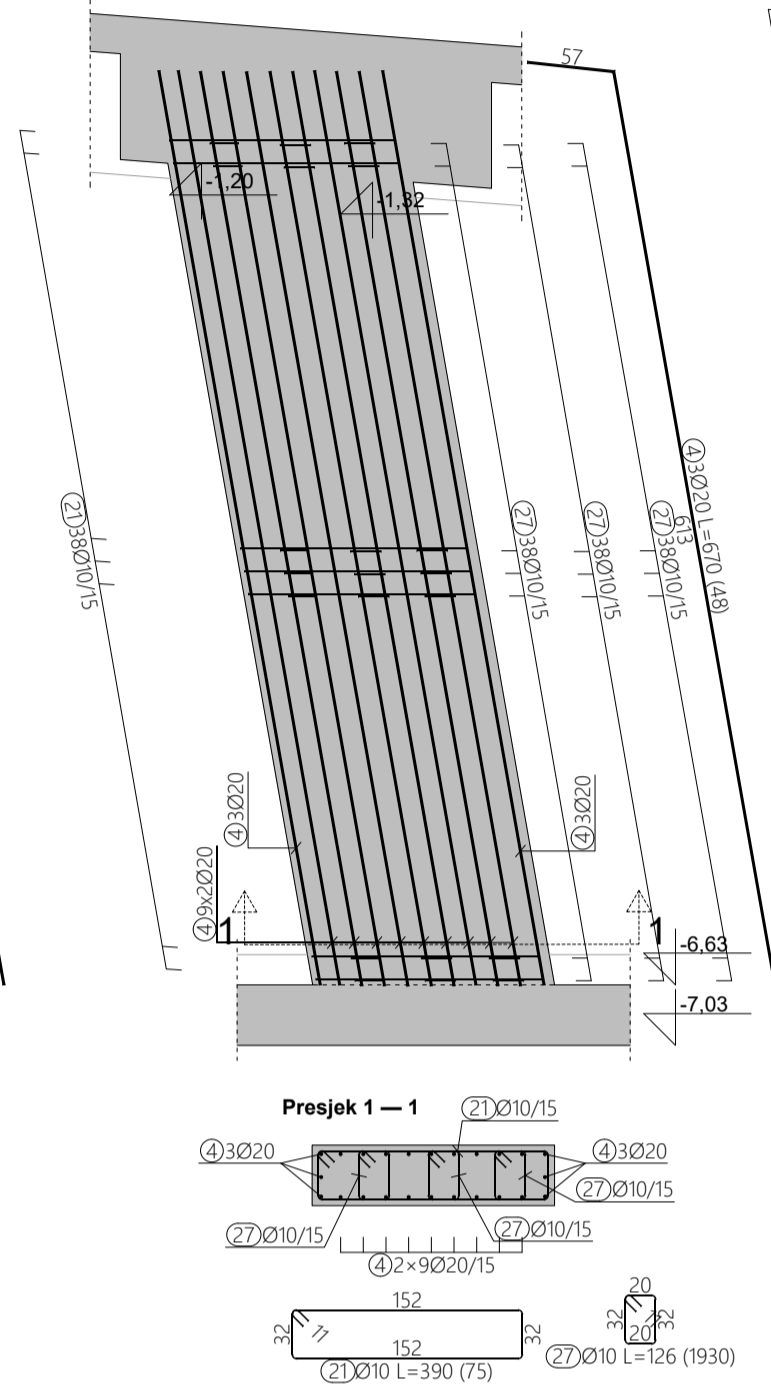

ARMATURA STUPA 3.3,
M 1:50

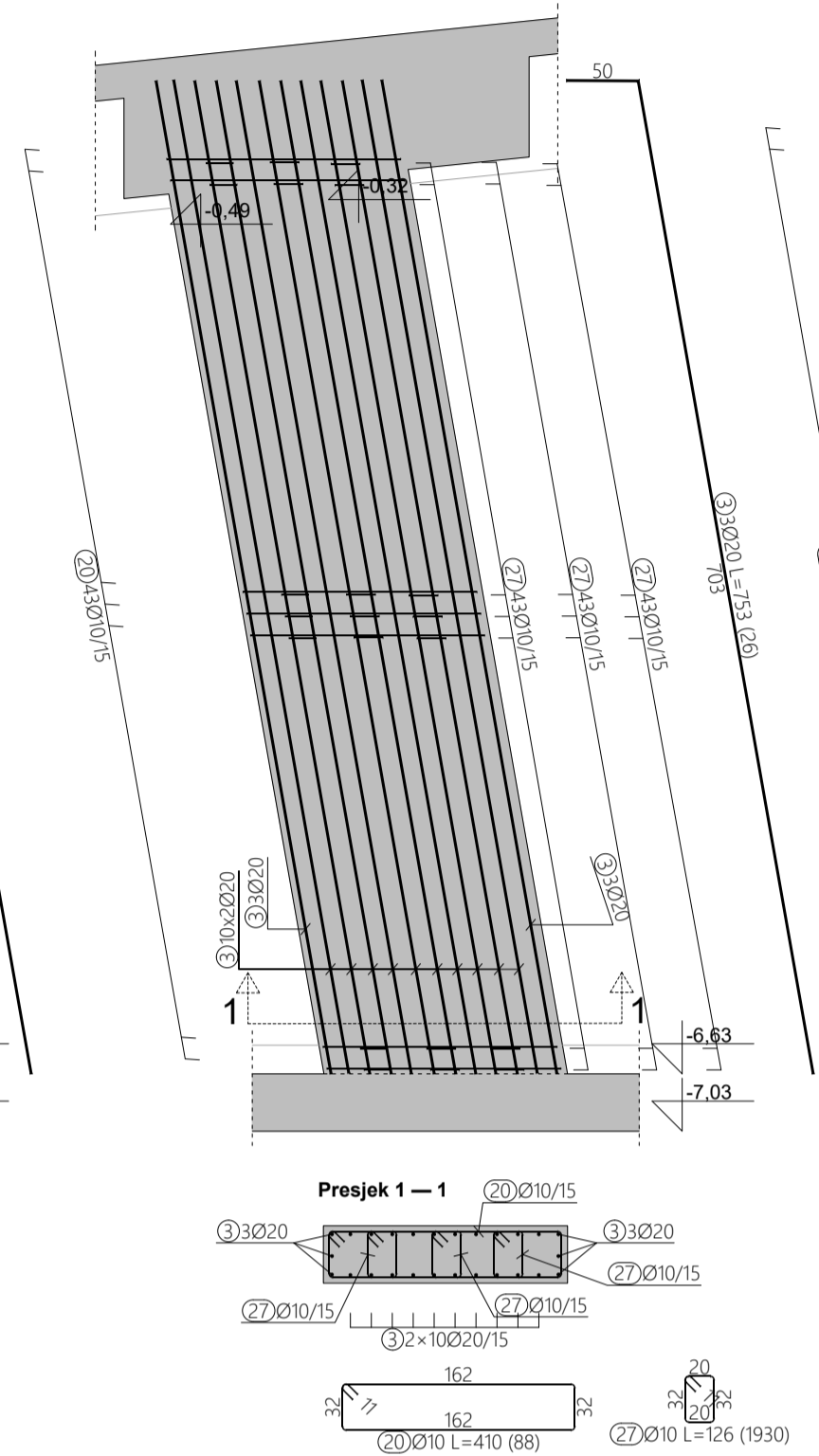

ARMATURA STUPA 3.4,
M 1:50



ARMATURA STUPA 3.5,
M 1:50

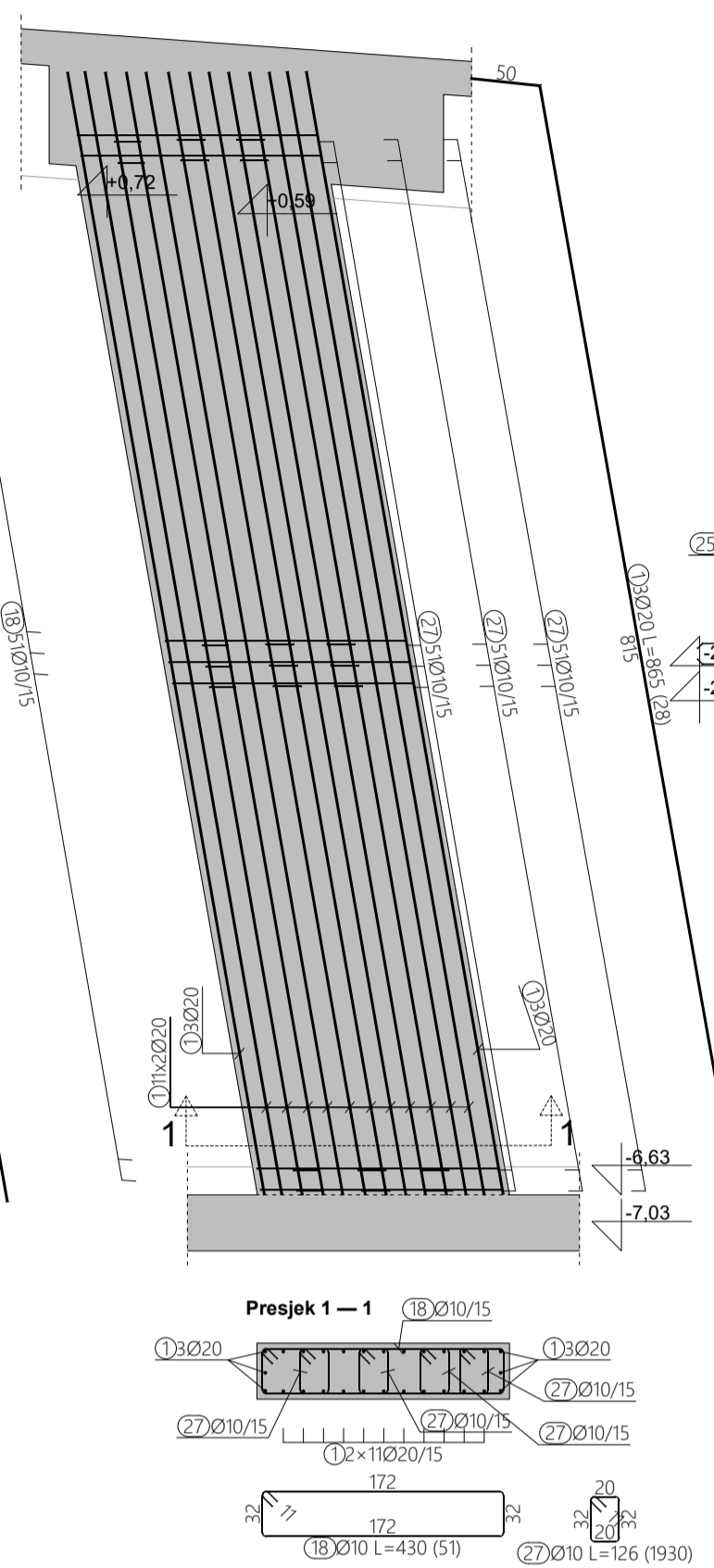

ARMATURA STUPA 3.6,
M 1:50

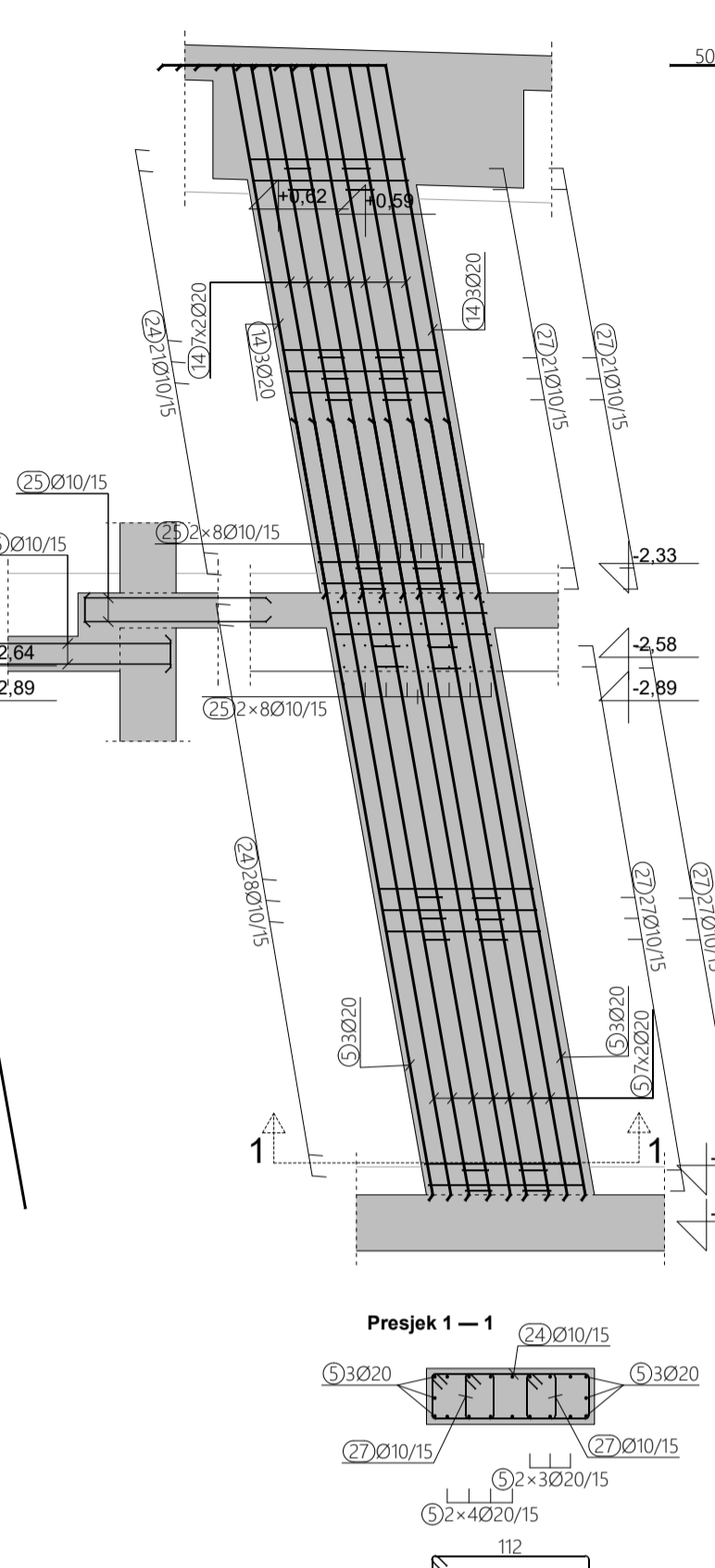

ARMATURA STUPA 3.7,
M 1:50

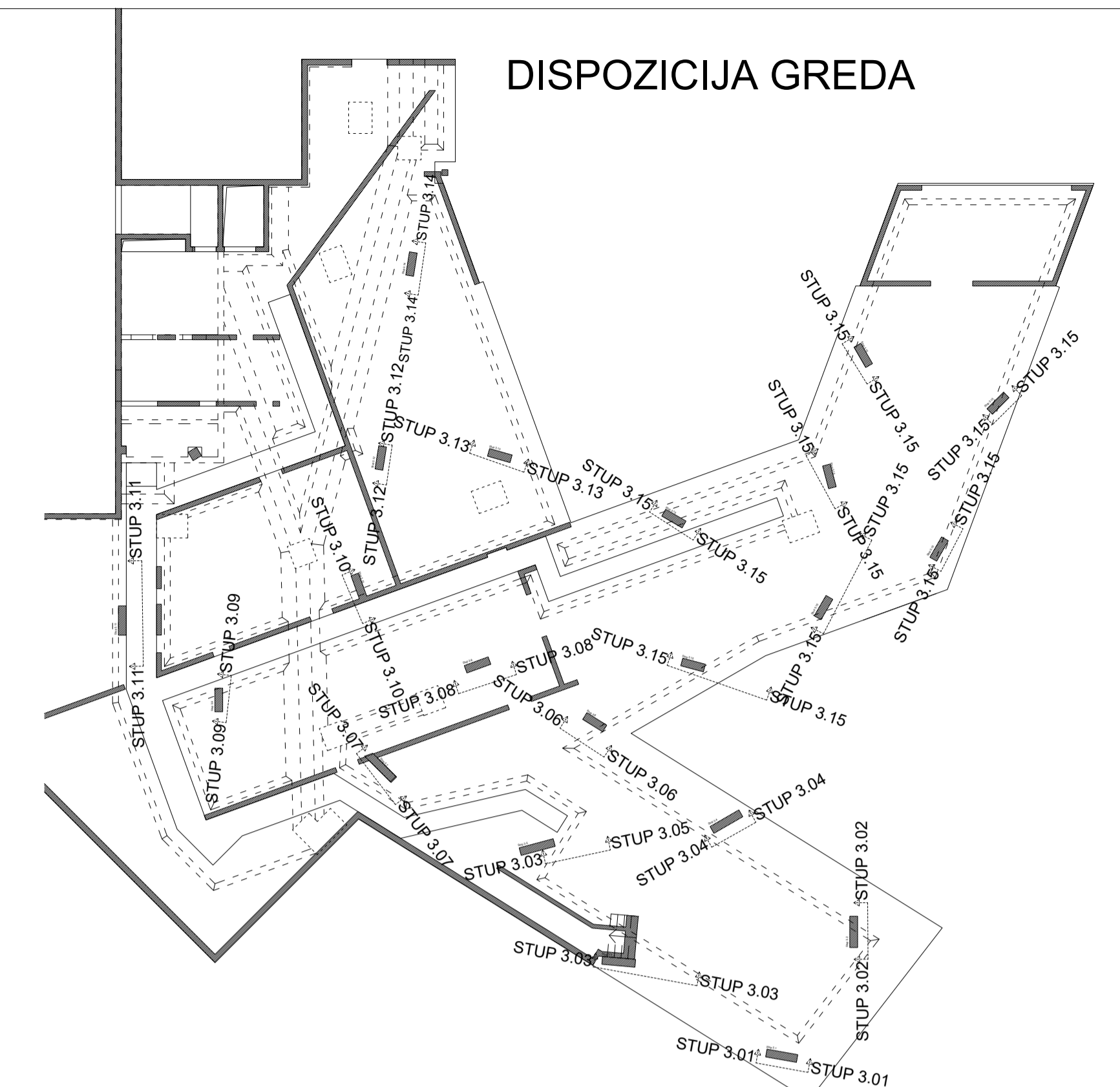
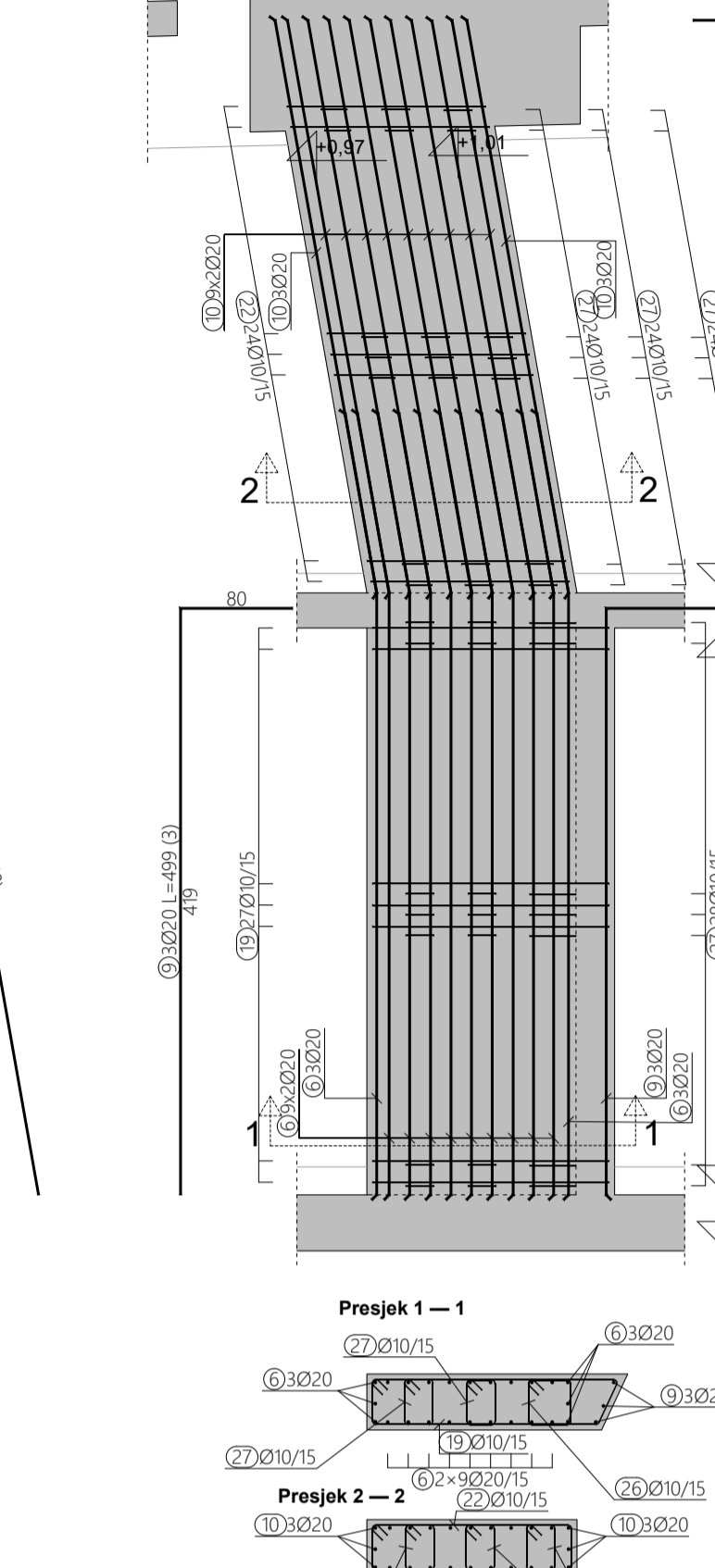

NAPOMENA

Šipke prilagoditi i po potrebi rezati na licu mjesta. Preklap 50Ø.

NAPOMENA

Sve dimenzije provjeriti prema važećim planovima oplate.

ARMATURA STUPA 3.8,
M 1:50

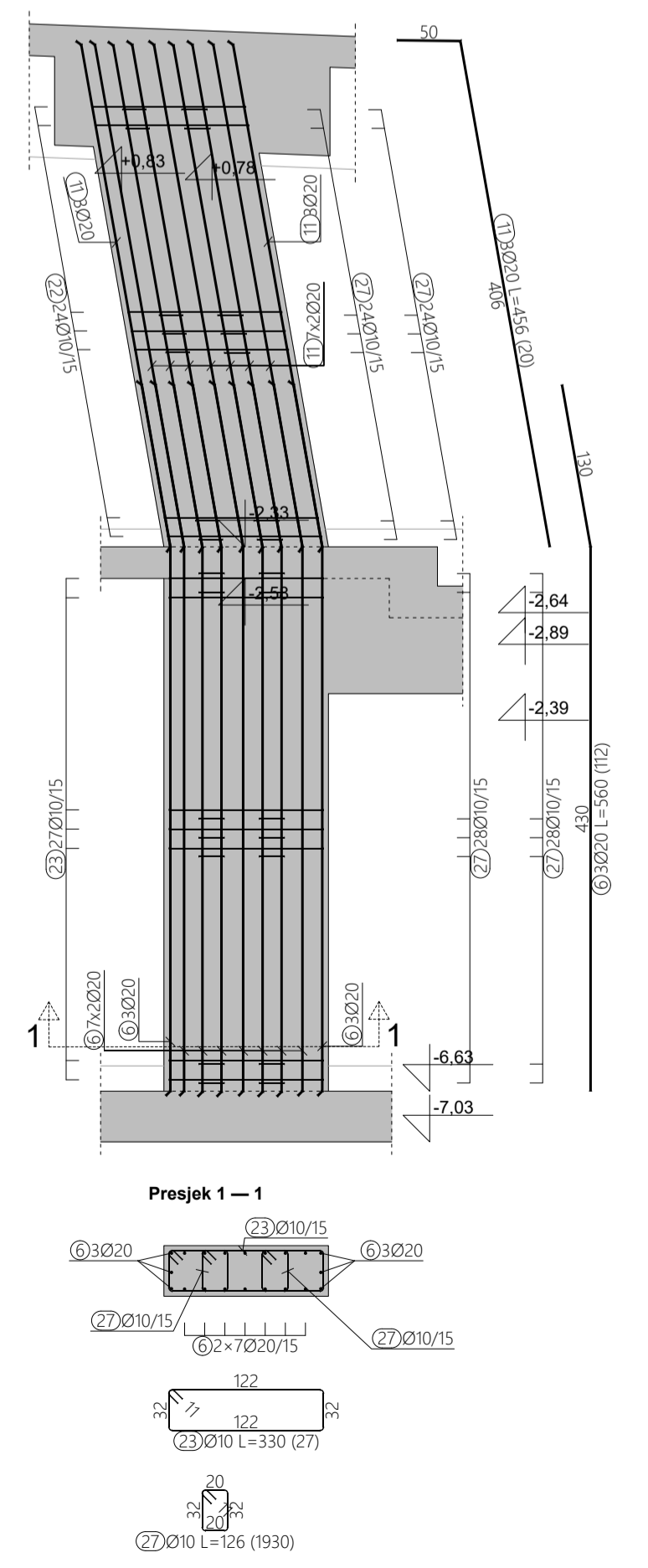

ARMATURA STUPA 3.9,
M 1:50

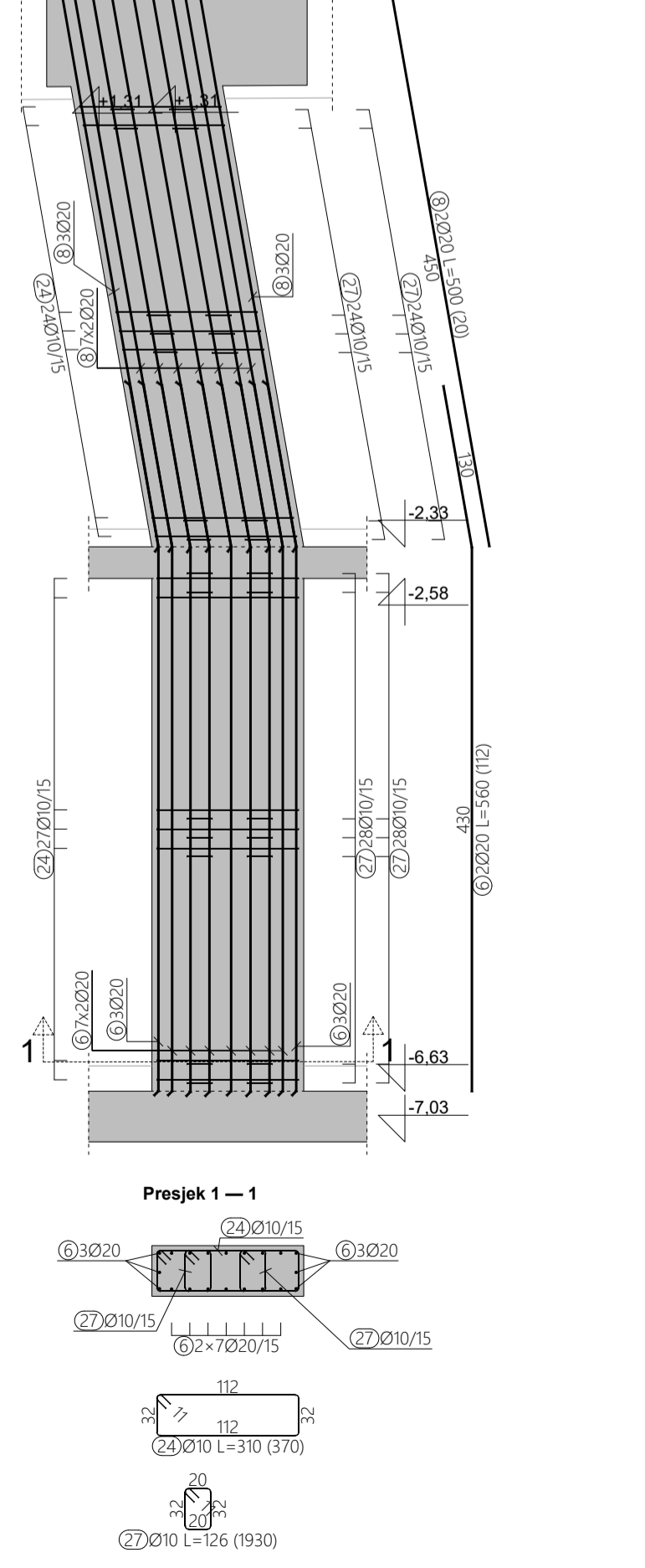

ARMATURA STUPA 3.10,
M 1:50

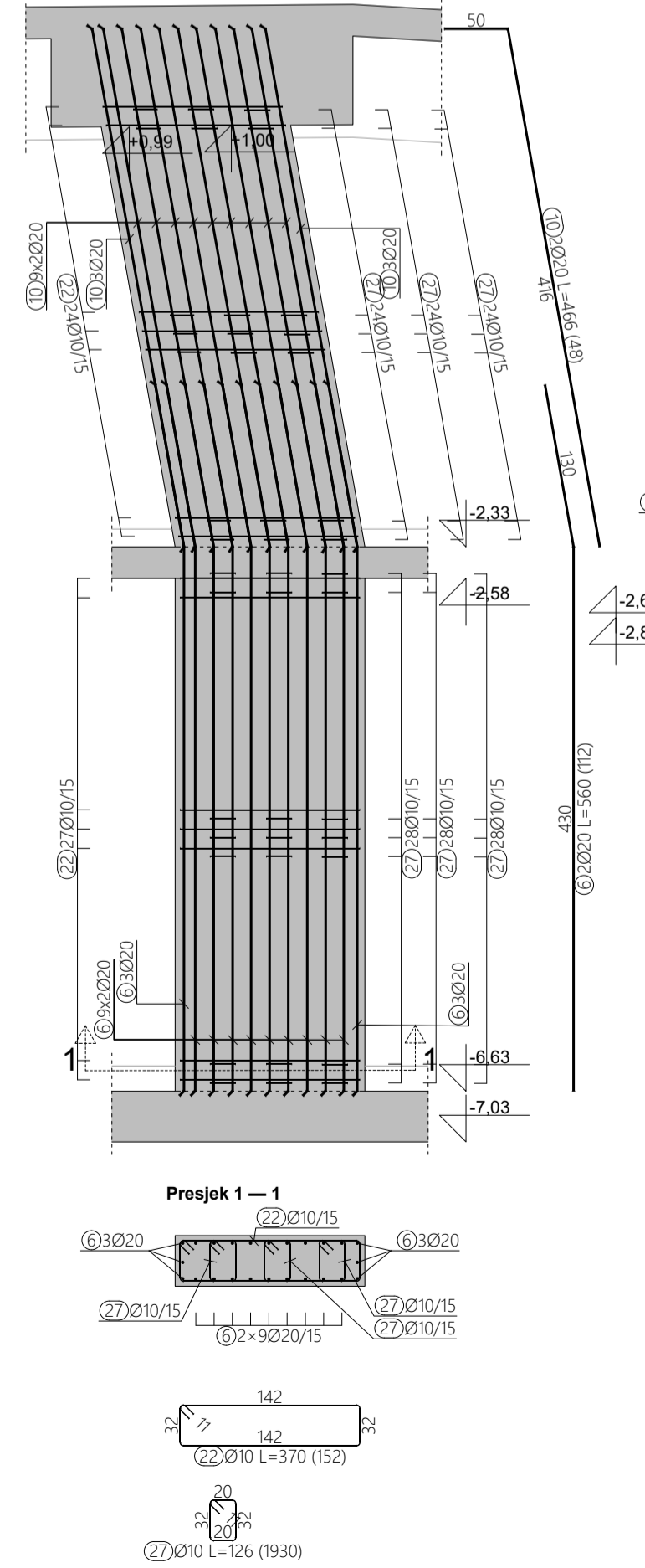

ARMATURA STUPA 3.11,
M 1:50

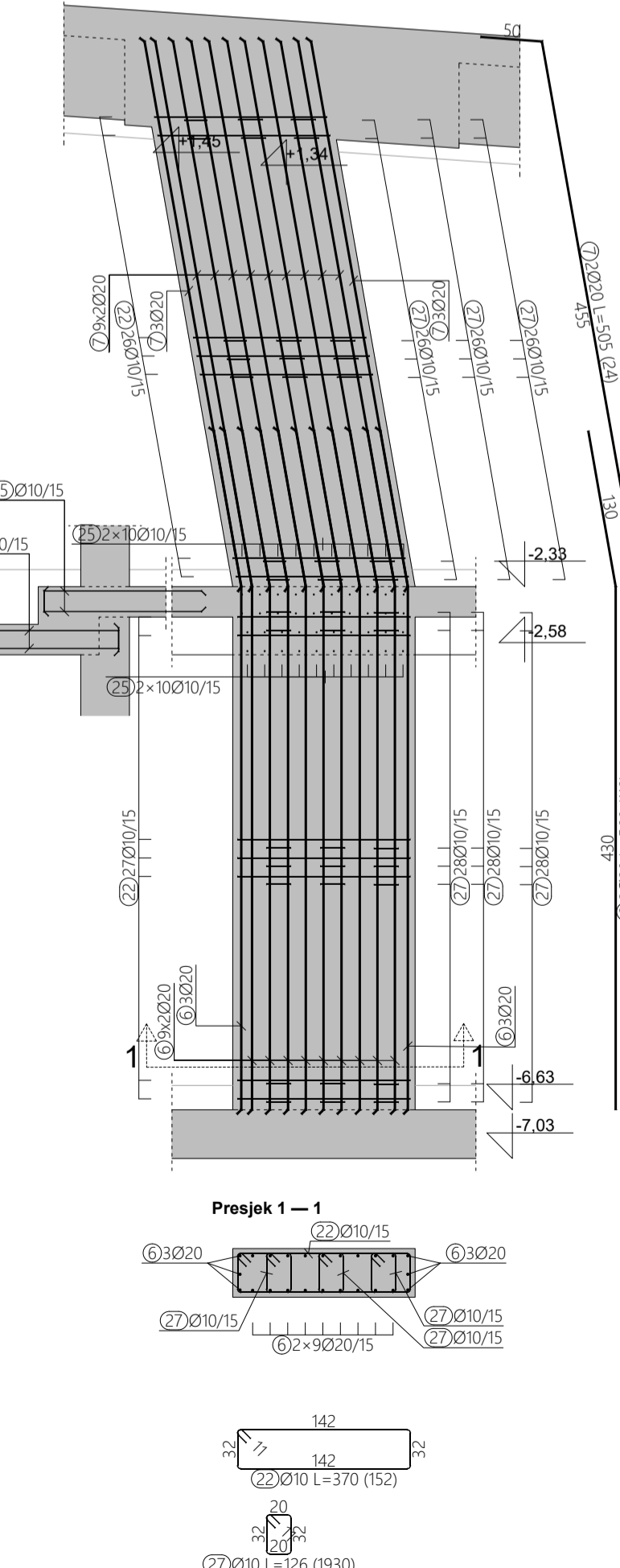

ARMATURA STUPA 3.12,
M 1:50

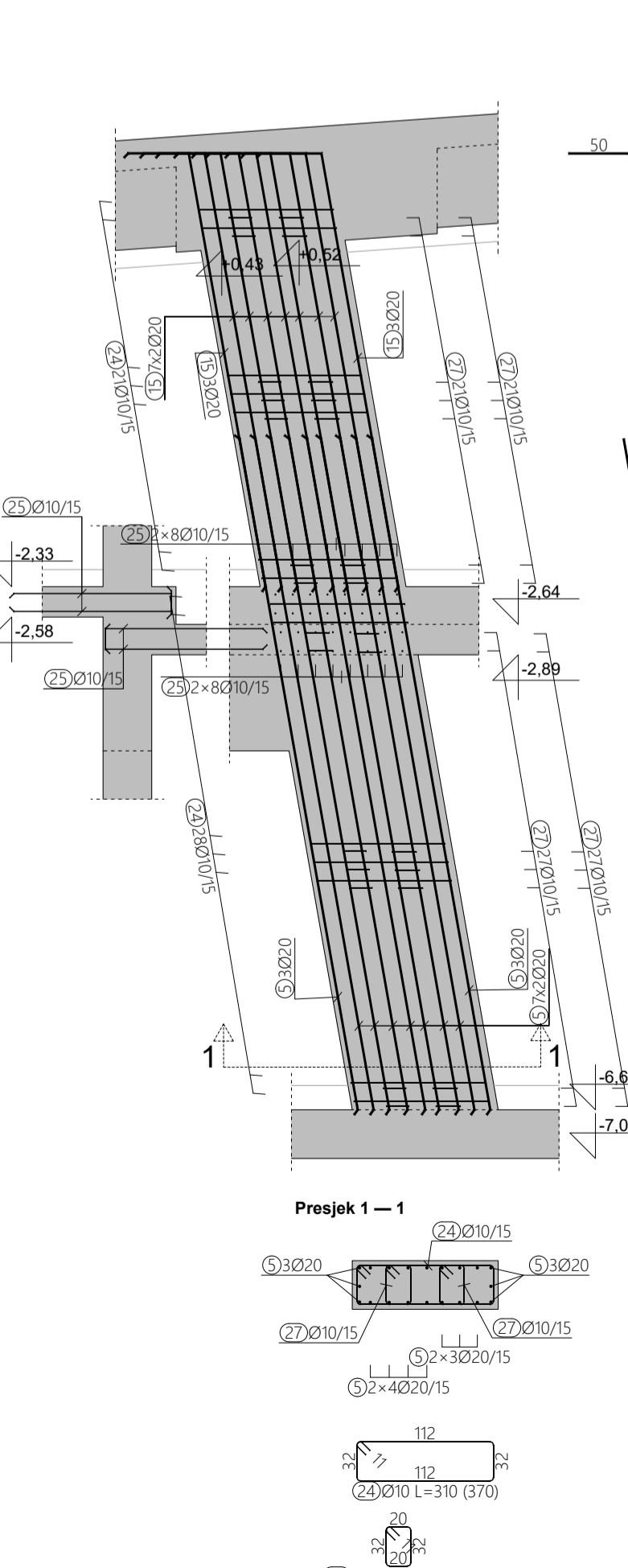

ARMATURA STUPA 3.13,
M 1:50

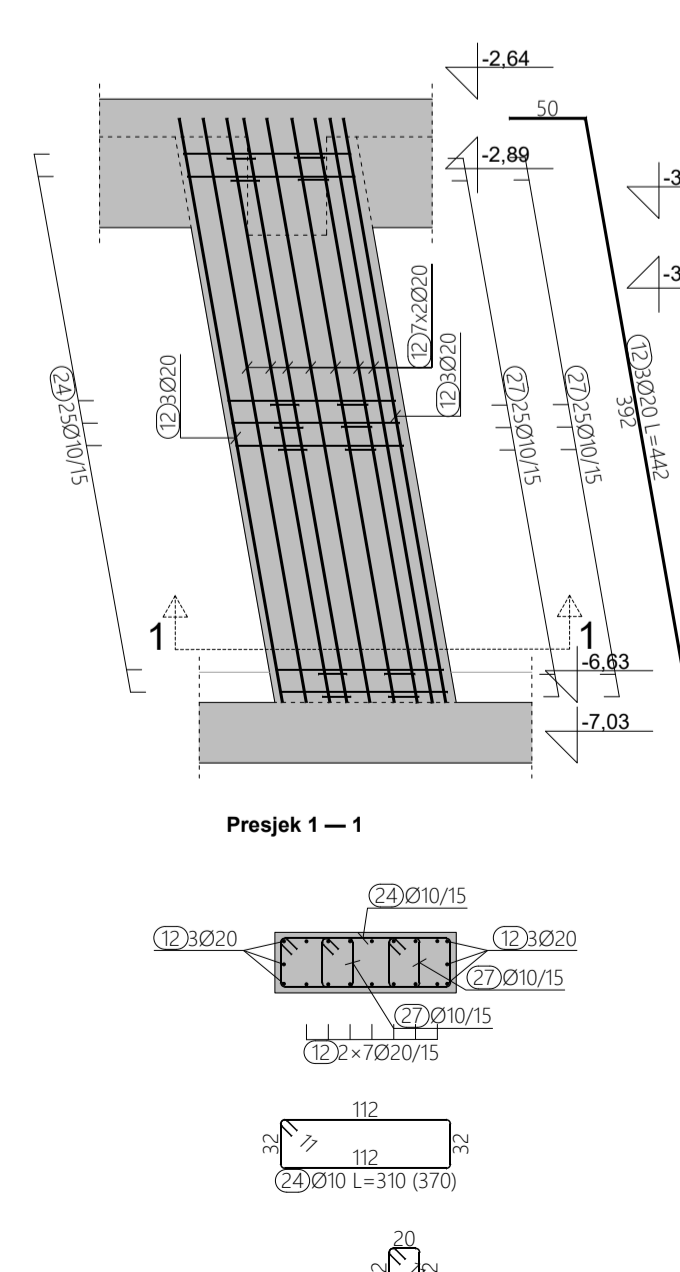

ARMATURA STUPA 3.14,
M 1:50

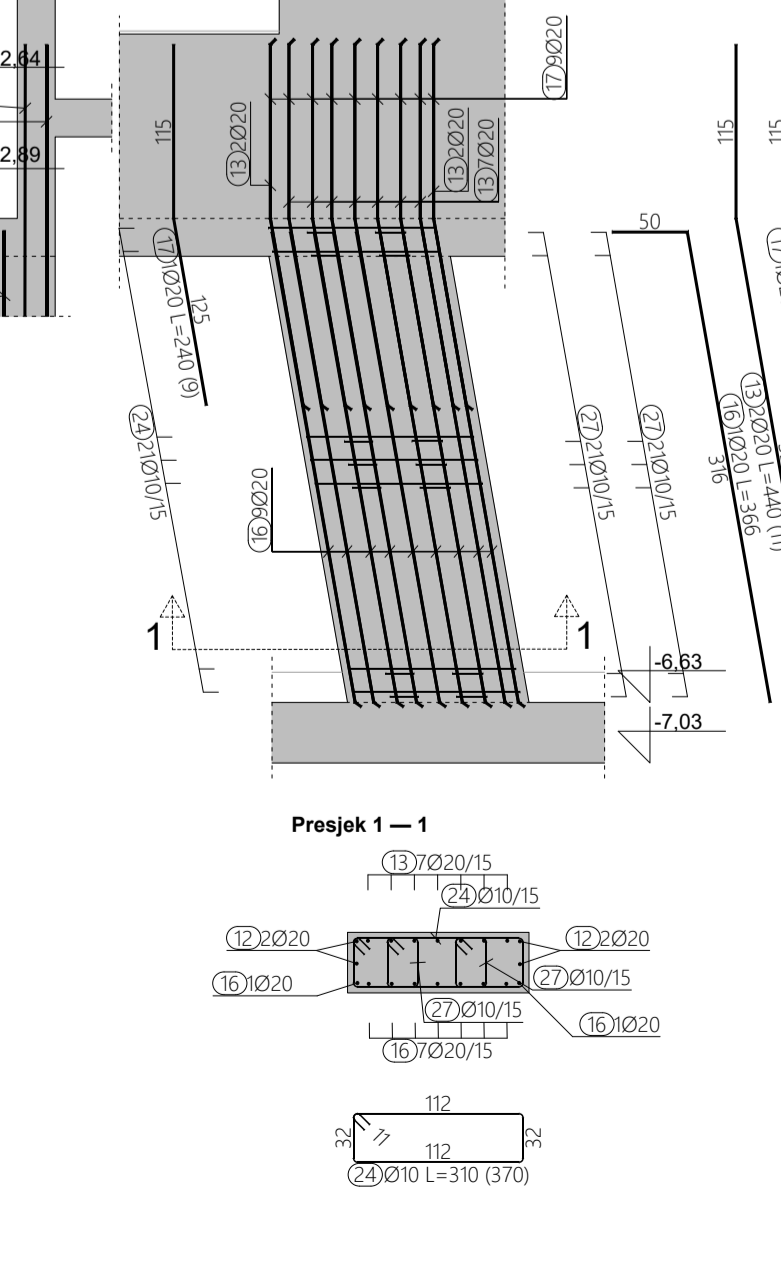

ARMATURA STUPA 3.15, (7 KOMADA)
M 1:50

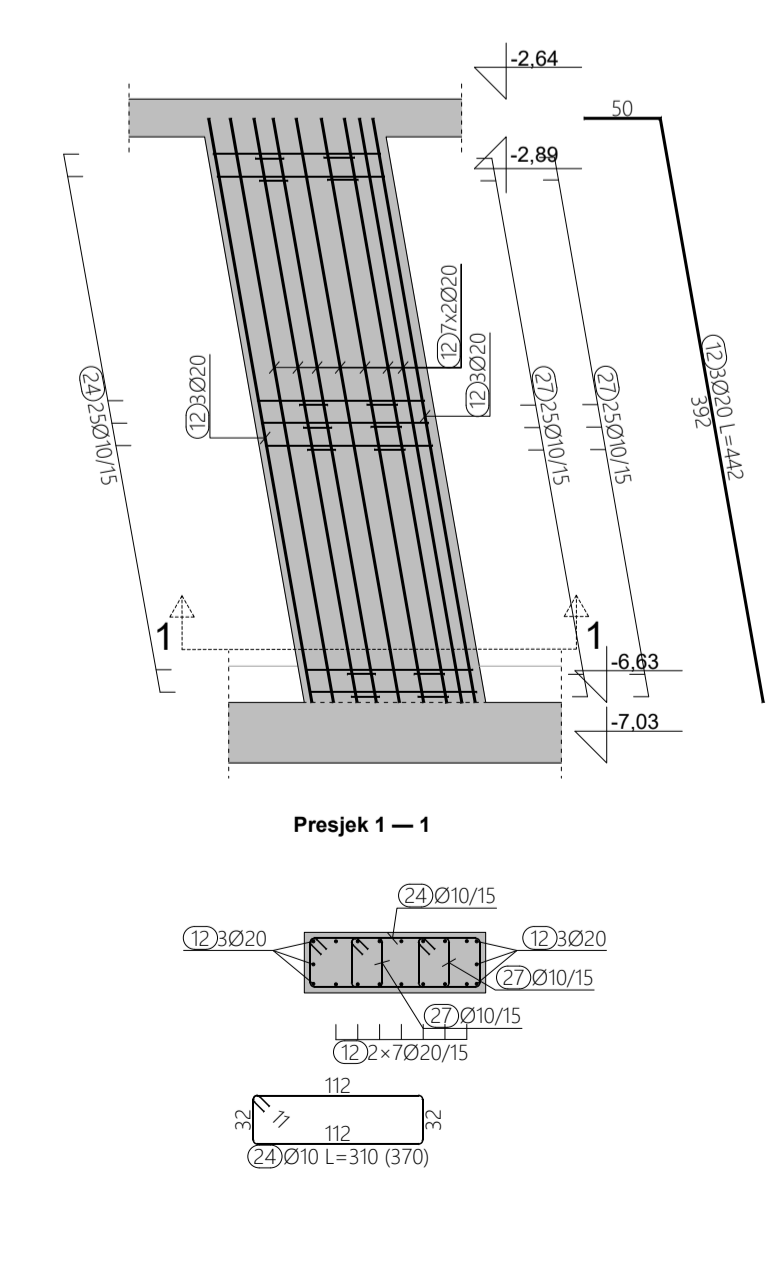

Klasa betona	C 30/37	
Armatura	B 500 B	
Zaštitni sloj betona	Pripadajuća lista armature: ARM_E-2_311_ISKAZ	
dolje	gore	bočno
4,0 cm	4,0 cm	4,0 cm
Pripadajući armaturni nacrti		
ARM_E-2_301-310		
ARM_E-1_301-304		

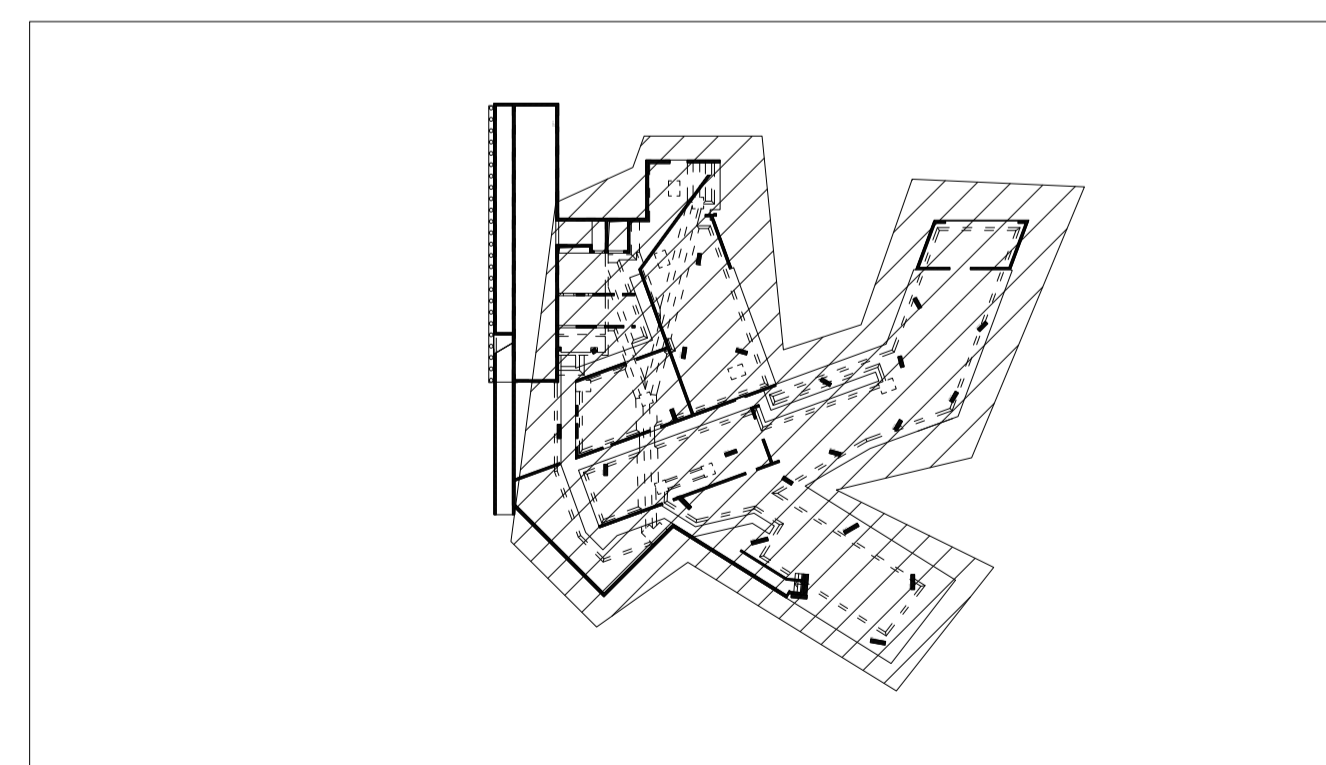

KONSTRUKTA PEČAT I POTPIS:

KONSTRUKTA d.o.o., za projektiranje i nadzor
Desinička 20, ZAGREB, OIB: 0687437679
ŽR: PRIVREDNA BANKA 2340009-1110164488
TEL: 01/36 43 828; FAX: 01/36 43 829
MAIL: info@konstrukt.hr

INVESTITOR: TERME TUHELJ d.o.o. Ljudevita Gaja 4, Tuhejske Toplice, 49215 Tuhei

GRAĐEVINA: REKONSTRUKCIJA TERMANOSKOP REKREACIJSKOG CENTRA TERME TUHELJ

LOKACIJA: na k.č.br. 3199/1, k.o. Črešnjevec

FAZA: IZVEDBENI PROJEKT - ARMATURNI NACRTI

SADRŽAJ: ELEMENT - DILATACIJA 3

GL. PROJEKTANT: Tomislav Vreš, dipl. ing. arh.

PROJEKT. IZV. PR. Antonio Maglov, dipl. ing. grad.

IZRADIO: Antonio Maglov, dipl. ing. grad.



DATUM: svibanj 2023.

MJERILO: 1:50; 1:25

REVIZIJA: 00

NACRT BR: **ARM - E-2 - 321**

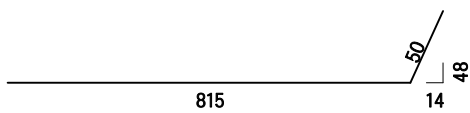
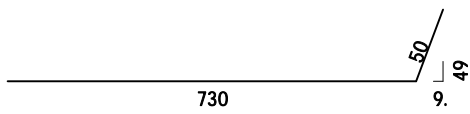
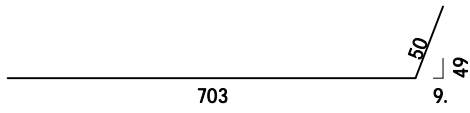
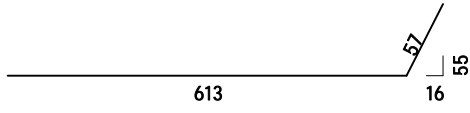
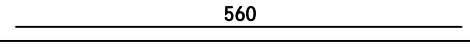
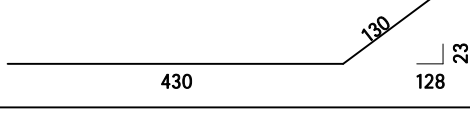
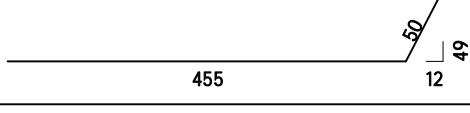
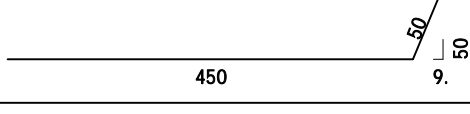
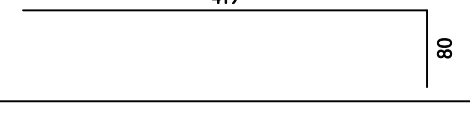
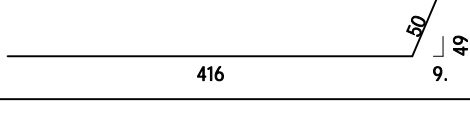
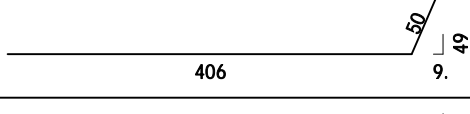
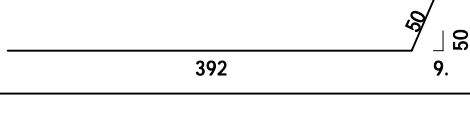
ISKAZ ARMATURE		
GRAĐEVINA:	REKONSTRUKCIJA TERMALNOG REK. CENT. TERME TUHELJ	
ISKAZ UZ NACRT:	ARM- E-2_321	
SADRŽAJ:	ARMATURA STUPOVA DILATACIJE 3	
DATUM:	24/06/2023	1/4

Šipke - specifikacija						
ozn	oblik i mjere [cm]	Ø	lg [m]	n [kom]	lgn [m]	Napomena
STUPOVI DIL3 (1 kom)						
1		20	8.65	28	242.20	
2		20	7.80	26	202.80	
3		20	7.53	26	195.78	
4		20	6.70	48	321.60	
5		20	5.60	40	224.00	
6		20	5.60	112	627.20	
7		20	5.05	24	121.20	
8		20	5.00	20	100.00	
9		20	4.99	3	14.97	
10		20	4.66	48	223.68	
11		20	4.56	20	91.20	
12		20	4.42	160	707.20	
13		20	4.40	11	48.40	

ISKAZ ARMATURE

GRAĐEVINA:	REKONSTRUKCIJA TERMALNOG REK. CENT. TERME TUHELJ	
ISKAZ UZ NACRT:	ARM- E-2_321	
SADRŽAJ:	ARMATURA STUPOVA DILATACIJE 3	
DATUM:	24/06/2023	2/4

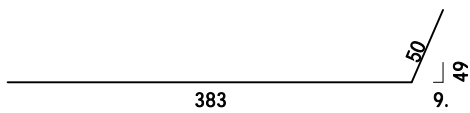
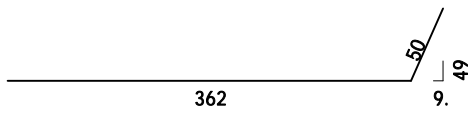
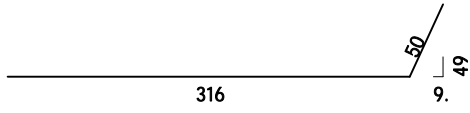
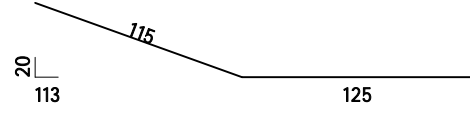
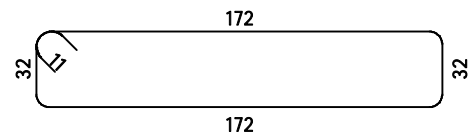
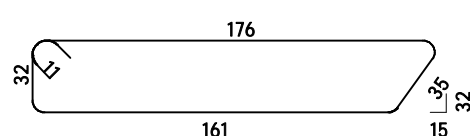
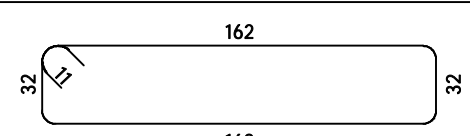
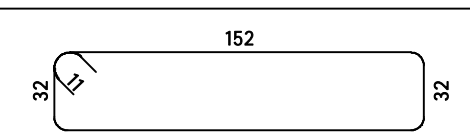
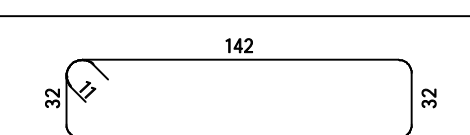
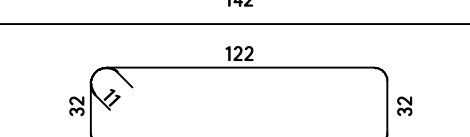
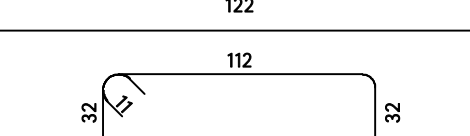
Šipke - specifikacija						
ozn	oblik i mjere [cm]	Ø	lg [m]	n [kom]	lgn [m]	Napomena
14		20	4.33	20	86.60	
15		20	4.12	20	82.40	
16		20	3.66	9	32.94	
17		20	2.40	9	21.60	
18		10	4.30	51	219.30	
19		10	4.26	27	115.02	
20		10	4.10	88	360.80	
21		10	3.90	75	292.50	
22		10	3.70	152	562.40	
23		10	3.30	27	89.10	
24		10	3.10	370	1147.00	



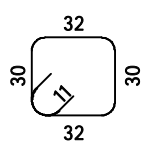
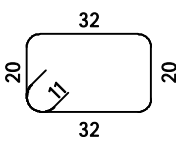

ISKAZ ARMATURE	
GRAĐEVINA:	REKONSTRUKCIJA TERMALNOG REK. CENT. TERME TUHELJ
ISKAZ UZ NACRT:	ARM- E-2_321
SADRŽAJ:	ARMATURA STUPOVA DILATACIJE 3
DATUM:	24/06/2023
	3/4

Šipke - specifikacija						
ozn	oblik i mjere [cm]	Ø	lg [m]	n [kom]	lgn [m]	Napomena
25		10	1.46	104	151.84	
26		10	1.46	28	40.88	
27		10	1.26	1930	2431.80	

ISKAZ ARMATURE		
GRAĐEVINA:	REKONSTRUKCIJA TERMALNOG REK. CENT. TERME TUHELJ	
ISKAZ UZ NACRT:	ARM- E-2_321	
SADRŽAJ:	ARMATURA STUPOVA DILATACIJE 3	
DATUM:	24/06/2023	4/4

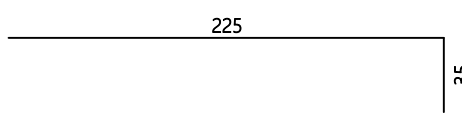
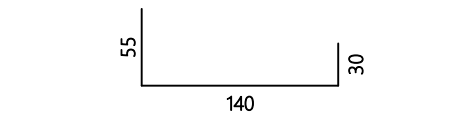
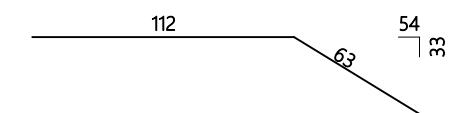
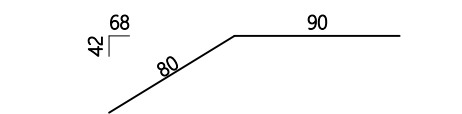
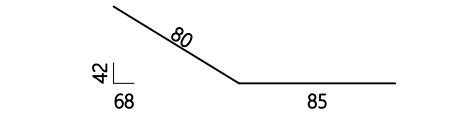
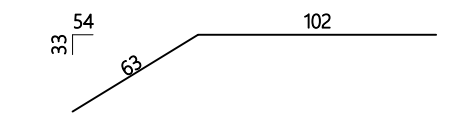
Šipke - rekapitulacija			
Ø [mm]	lgn [m]	Jedinična težina [kg/m']	Težina [kg]
B500B			
10	5410.64	0.62	3338.36
16	0.00	1.58	0.00
20	3343.77	2.47	8259.11
25	0.00	3.85	0.00
32	0.00	6.31	0.00
Ukupno (B500B)			11597.48
Ukupno			11597.48

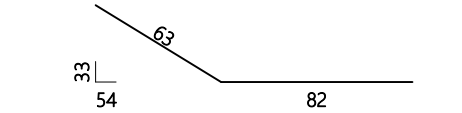
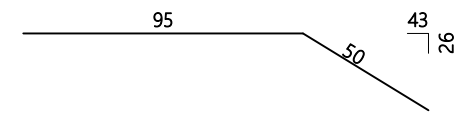
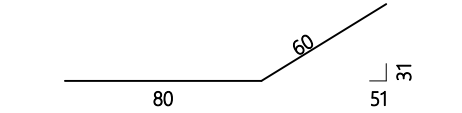
ISKAZ ARMATURE		
GRAĐEVINA:	REKONSTRUKCIJA TERMALNOG REKREACIJSKOG CENTRA TERME TUHELJ	
ISKAZ UZ NACRT:	ARM_E-3_351_0	
SADRŽAJ:	ARMATURA STUBIŠTA	
DATUM:	lipanj, 2023.	1/4

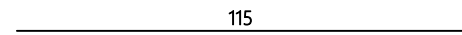
Šipke - specifikacija						
ozn	oblik i mjere [cm]	Ø	lg [m]	n [kom]	lgn [m]	Napomena
Armatura stubišta (1 kom)						
1		14	2.60	10	26.00	
2		14	2.25	2	4.50	
3		10	1.75	10	17.50	
4		10	1.70	12	20.40	
5		10	1.65	12	19.80	
6		10	1.65	10	16.50	
7		10	1.60	10	16.00	
8		10	1.45	10	14.50	
9		10	1.45	10	14.50	
10		10	1.40	12	16.80	
11		10	1.35	10	13.50	
12		8	1.15	12	13.80	

ISKAZ ARMATURE	
GRAĐEVINA:	REKONSTRUKCIJA TERMALNOG REKREACIJSKOG CENTRA TERME TUHELJ
ISKAZ UZ NACRT:	ARM_E-3_351_0
SADRŽAJ:	ARMATURA STUBIŠTA
DATUM:	lipanj, 2023. 2/4

Šipke - specifikacija						
ozn	oblik i mjere [cm]	Ø	lg [m]	n [kom]	lgn [m]	Napomena
13		8	0.76	8	6.08	
14		8	0.70	8	5.60	



ISKAZ ARMATURE			
GRAĐEVINA:	REKONSTRUKCIJA TERMALNOG REKREACIJSKOG CENTRA TERME TUHELJ		
ISKAZ UZ NACRT:	ARM_E-3_351_0		
SADRŽAJ:	ARMATURA STUBIŠTA		
DATUM:	lipanj, 2023.		3/4

Šipke - rekapitulacija			
Ø [mm]	lgn [m]	Jedinična težina [kg/m']	Težina [kg]
B500B			
8	25.48	0.40	10.06
10	149.50	0.62	92.24
14	30.50	1.21	36.91
Ukupno (B500B)			139.21
Ukupno			139.21

ISKAZ ARMATURE	
GRAĐEVINA:	REKONSTRUKCIJA TERMALNOG REKREACIJSKOG CENTRA TERME TUHELJ
ISKAZ UZ NACRT:	ARM_E-3_351_0
SADRŽAJ:	ARMATURA STUBIŠTA
DATUM:	lipanj, 2023. 4/4

Mreže - specifikacija							
Polozicija	Oznaka mreže	B [cm]	L [cm]	n	Jedinična težina [kg/m ²]	Ukupna težina [kg]	Napomena
Armatura stubišta (1 kom)							
1-1	Q-636	116	282	1	10.10	33.02	
1-2	Q-636	125	250	2	10.10	63.12	
1-3	Q-636	116	273	1	10.10	31.94	
2-1	Q-257	116	282	1	4.12	13.47	
2-2	Q-257	116	273	1	4.12	13.03	
Ukupno						154.59	

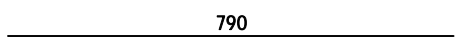
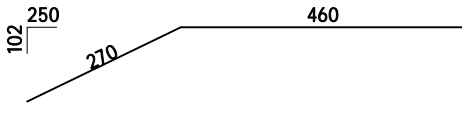
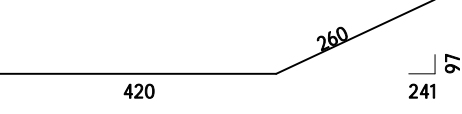
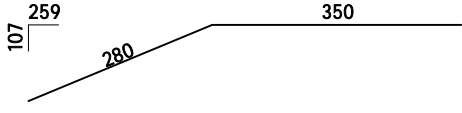
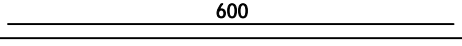
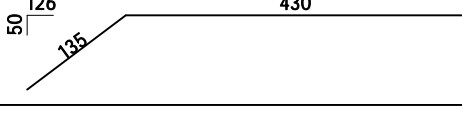
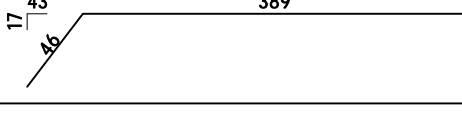
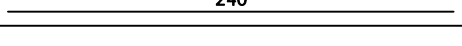
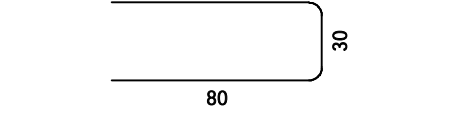
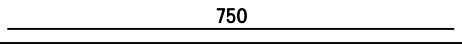
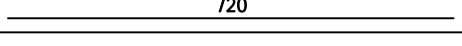
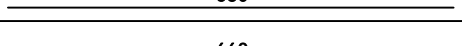
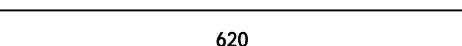
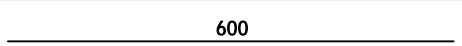
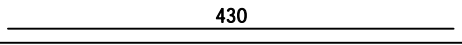
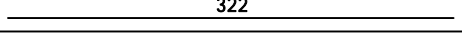
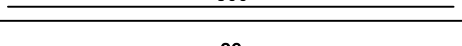
ISKAZ ARMATURE	
GRAĐEVINA:	REKONSTRUKCIJA TERMALNOG REKREACIJSKOG CENTRA TERME TUHELJ
ISKAZ UZ NACRT:	E-2_352
SADRŽAJ:	ARMATURA STUBIŠTA OKOLIŠA
DATUM:	srpanj, 2023.

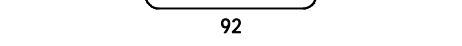
Šipke - specifikacija						
ozn	oblik i mjere [cm]	Ø	lg [m]	n [kom]	lgn [m]	Napomena
STUBIŠTE - OKOLIŠ (1 kom)						
1		16	7.90	8	63.20	
2		16	7.30	6	43.80	
3		16	6.80	12	81.60	
4		16	6.30	6	37.80	
5		16	6.00	8	48.00	
6		16	5.65	6	33.90	
7		16	4.35	6	26.10	
8		16	2.40	6	14.40	
9		16	1.90	16	30.40	
10		14	7.50	4	30.00	
11		14	7.20	4	28.80	
12		14	6.80	4	27.20	
13		14	6.60	4	26.40	
14		14	6.20	4	24.80	
15		10	6.00	10	60.00	
16		10	4.30	40	172.00	
17		10	3.22	20	64.40	
18		10	3.00	40	120.00	
19		10	2.90	37	107.30	

ISKAZ ARMATURE

GRAĐEVINA:	REKONSTRUKCIJA TERMALNOG REKREACIJSKOG CENTRA TERME TUHELJ
ISKAZ UZ NACRT:	E-2_352
SADRŽAJ:	ARMATURA STUBIŠTA OKOLIŠA
DATUM:	srpanj, 2023.

Šipke - specifikacija						
ozn	oblik i mjere [cm]	Ø	lg [m]	n [kom]	lgn [m]	Napomena
20		10	2.38	176	418.88	
21		10	2.05	20	41.00	
22		10	1.80	20	36.00	
23		10	1.13	20	22.60	
24		8	7.90	10	79.00	
25		8	2.74	49	134.26	
26		8	2.00	41	82.00	
27		8	1.62	194	314.28	
28		8	1.29	85	109.65	
29		8	1.18	128	151.04	
30		8	1.15	85	97.75	
31		8	1.15	85	97.75	

ISKAZ ARMATURE	
GRAĐEVINA:	REKONSTRUKCIJA TERMALNOG REKREACIJSKOG CENTRA TERME TUHELJ
ISKAZ UZ NACRT:	E-2_352
SADRŽAJ:	ARMATURA STUBIŠTA OKOLIŠA
DATUM:	srpanj, 2023.

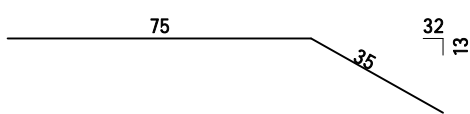
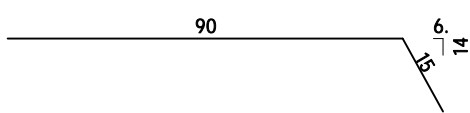
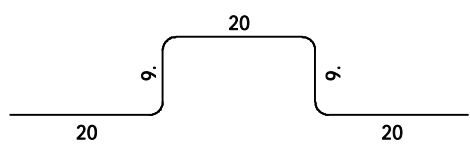
Šipke - specifikacija						
ozn	oblik i mjere [cm]	Ø	lg [m]	n [kom]	lgn [m]	Napomena
32		8	1.10	256	281.60	
33		8	1.05	98	102.90	
34		8	0.78	100	78.00	

ISKAZ ARMATURE	
GRAĐEVINA:	REKONSTRUKCIJA TERMALNOG REKREACIJSKOG CENTRA TERME TUHELJ
ISKAZ UZ NACRT:	E-2_352
SADRŽAJ:	ARMATURA STUBIŠTA OKOLIŠA
DATUM:	srpanj, 2023.

Šipke - rekapitulacija			
Ø [mm]	lgn [m]	Jedinična težina [kg/m ¹]	Težina [kg]
B500B			
8	1528.23	0.40	603.65
10	1042.18	0.62	643.03
14	137.20	1.21	166.01
16	379.20	1.58	599.14
Ukupno (B500B)			2011.82
Ukupno			2011.82

ISKAZ ARMATURE	
GRAĐEVINA:	REKONSTRUKCIJA TERMALNOG REKREACIJSKOG CENTRA TERME TUHELJ
ISKAZ UZ NACRT:	E-2_352
SADRŽAJ:	ARMATURA STUBIŠTA OKOLIŠA
DATUM:	srpanj, 2023.

Mreže - specifikacija							
Pozicija	Oznaka mreže	B [cm]	L [cm]	n	Jedinična težina [kg/m ²]	Ukupna težina [kg]	Napomena
STUBIŠTE - OKOLIŠ (1 kom)							
1-1	Q-335	215	340	12	5.38	471.57	
1-2	Q-335	132	340	2	5.38	48.34	
1-3	Q-335	185	112	2	5.38	22.34	
1-4	Q-335	185	600	4	5.38	238.87	
1-5	Q-335	117	600	2	5.38	75.64	
1-6	Q-335	198	340	2	5.38	72.52	
1-7	Q-335	215	303	8	5.38	280.58	
1-8	Q-335	90	303	2	5.38	29.35	
1-9	Q-335	185	178	2	5.38	35.51	
Ukupno						1274.73	

ISKAZ ARMATURE	
GRAĐEVINA:	REKONSTRUKCIJA TERMALNOG REKREACIJSKOG CENTRA TERME TUHELJ
ISKAZ UZ NACRT:	E-2_352
SADRŽAJ:	ARMATURA STUBIŠTA OKOLIŠA
DATUM:	srpanj, 2023.

Mreže - rekapitulacija						
Oznaka mreže	B [cm]	L [cm]	n	Jedinična težina [kg/m ²]	Ukupna težina [kg]	Neto ugrađena težina [kg]
Q-335	215	600	30	5.38	2082.06	1247.34
Ukupno					2082.06	1247.34

ISKAZ ARMATURE	
GRAĐEVINA:	REKONSTRUKCIJA TERMALNOG REKREACIJSKOG CENTRA TERME TUHELJ
ISKAZ UZ NACRT:	E-2_352
SADRŽAJ:	ARMATURA STUBIŠTA OKOLIŠA
DATUM:	srpanj, 2023.

Mreže - plan rezanja
STUBIŠTE - OKOLIŠ
Q-335 (600 cm x 215 cm)

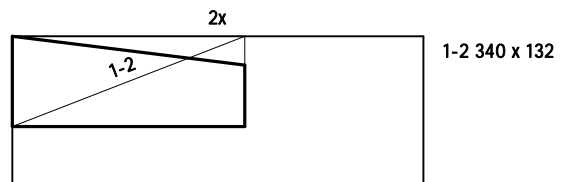
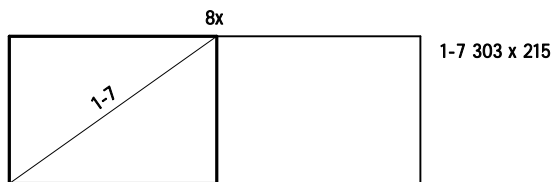
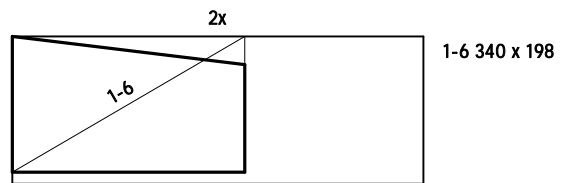
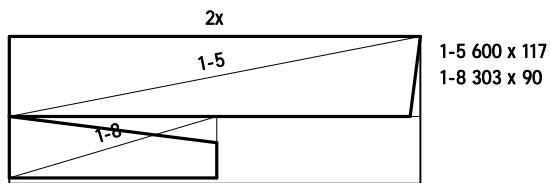
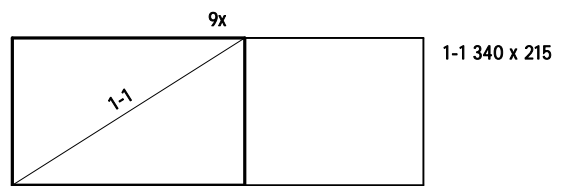
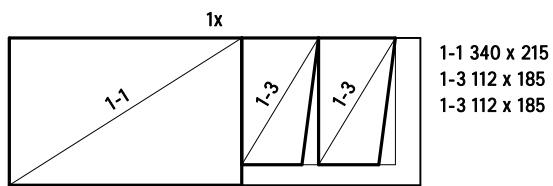
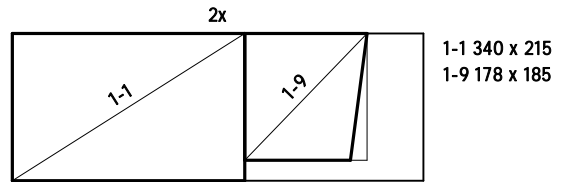
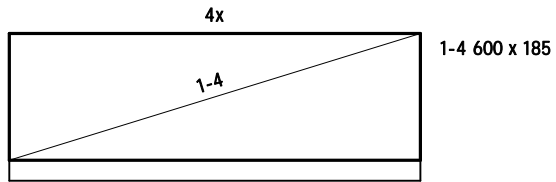

ARMATURA GREDE 3.13, M 1:50

ARMATURA GREDE 3.12, M 1:50

ARMATURA GREDE 3.11, M 1:50

ARMATURA GREDE 3.10, M 1:50

ARMATURA GREDE 3.09, M 1:50

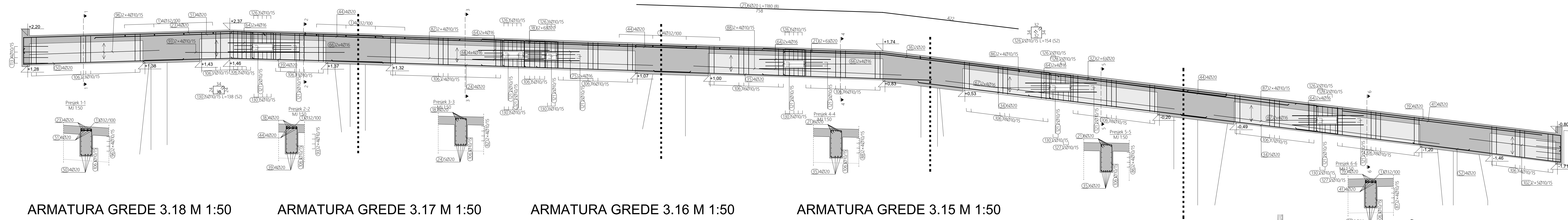

ARMATURA GREDE 3.18 M 1:50

ARMATURA GREDE 3.17 M 1:50

ARMATURA GREDE 3.16 M 1:50

ARMATURA GREDE 3.15 M 1:50

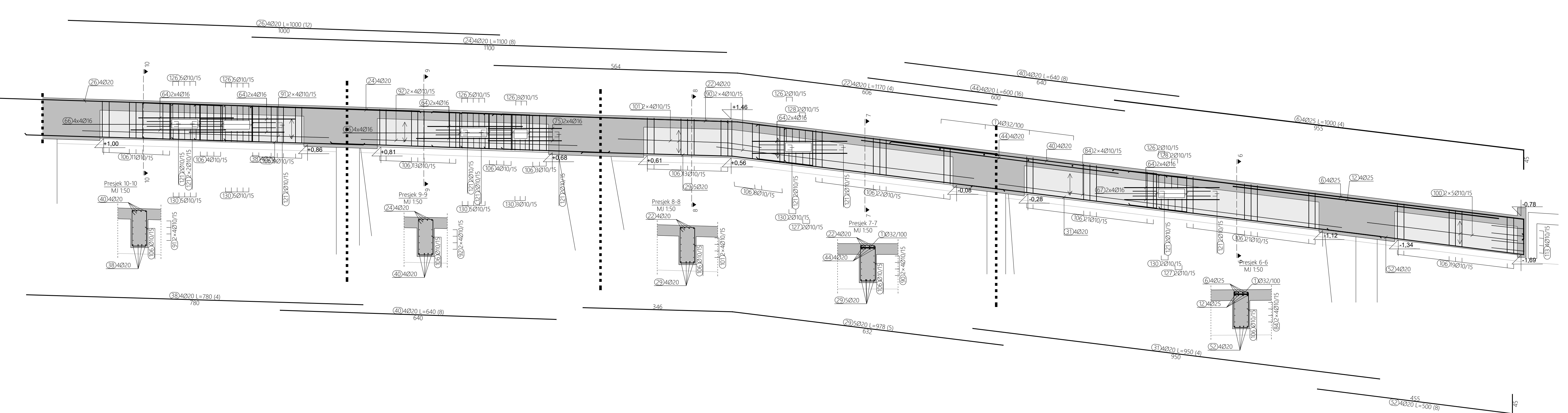

DISPOZICIJA GREDA

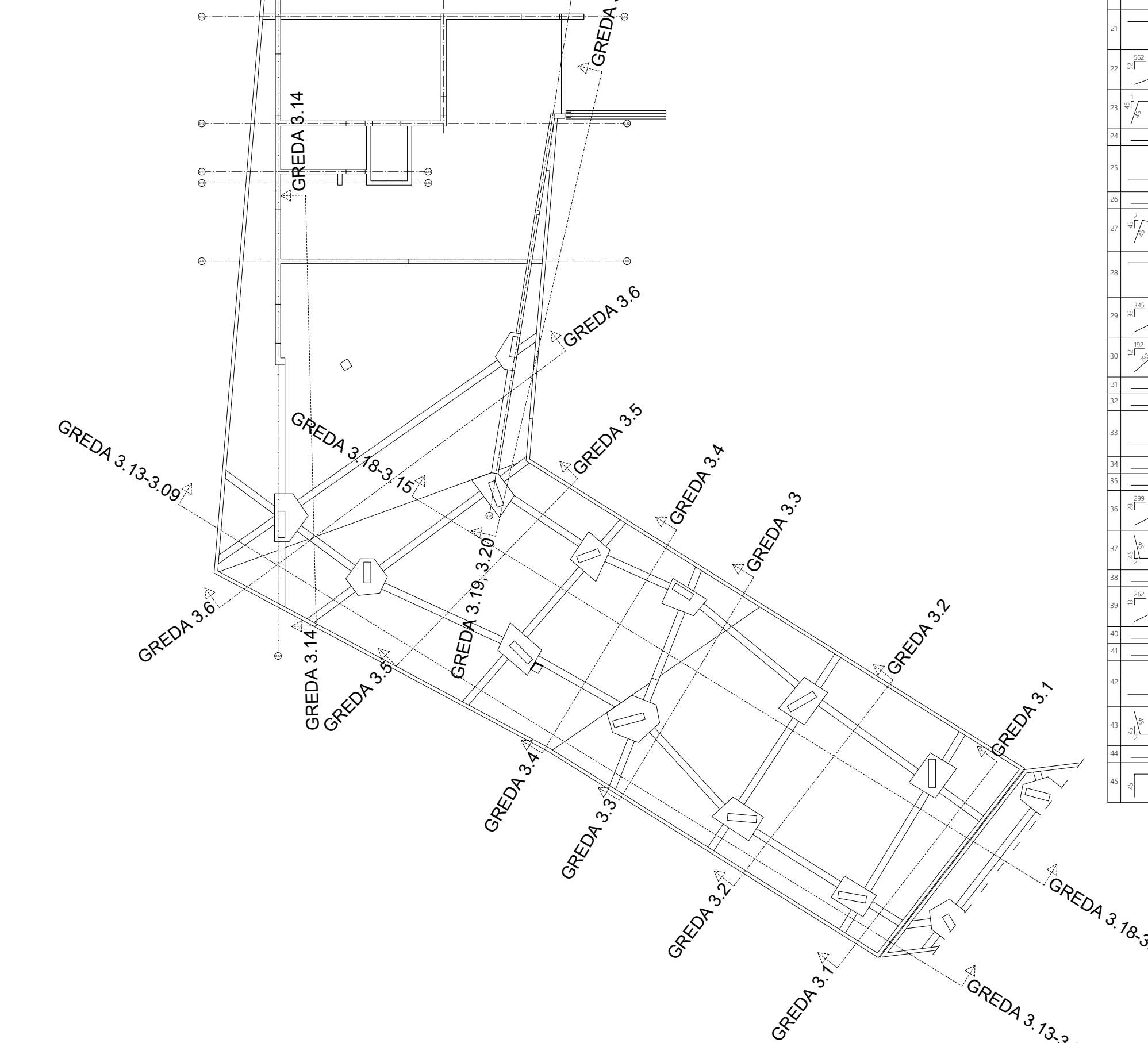

1	2	3	4	5	6	7	8	9	10	11	12	13	14	15	16	17	18	19	20	21	22	23	24	25	26	27	28	29	30	31	32	33	34	35	36	37	38	39	40	41	42	43	44	45	46	47	48	49	50	51	52	53	54	55	56	57	58	59	60	61	62	63	64	65	66	67	68	69	70	71	72	73	74	75	76	77	78	79	80	81	82	83	84	85	86	87	88	89	90	91	92	93	94	95	96	97	98	99	100
---	---	---	---	---	---	---	---	---	----	----	----	----	----	----	----	----	----	----	----	----	----	----	----	----	----	----	----	----	----	----	----	----	----	----	----	----	----	----	----	----	----	----	----	----	----	----	----	----	----	----	----	----	----	----	----	----	----	----	----	----	----	----	----	----	----	----	----	----	----	----	----	----	----	----	----	----	----	----	----	----	----	----	----	----	----	----	----	----	----	----	----	----	----	----	----	----	----	----	-----

ARMATURA GREDE 3.1, M 1:50

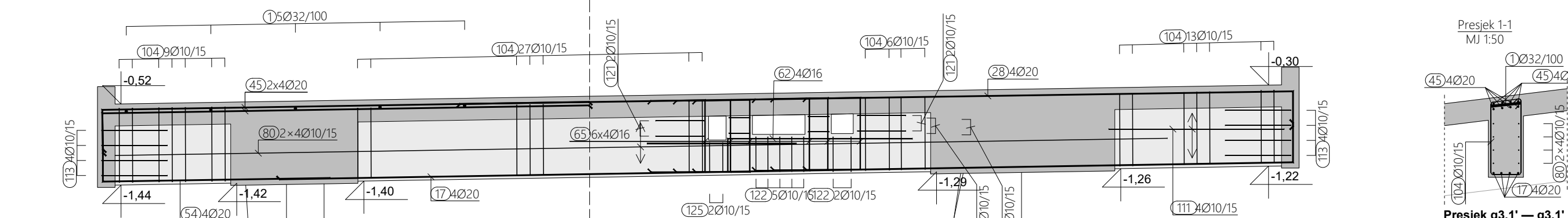

ARMATURA GREDE 3.2, M 1:50

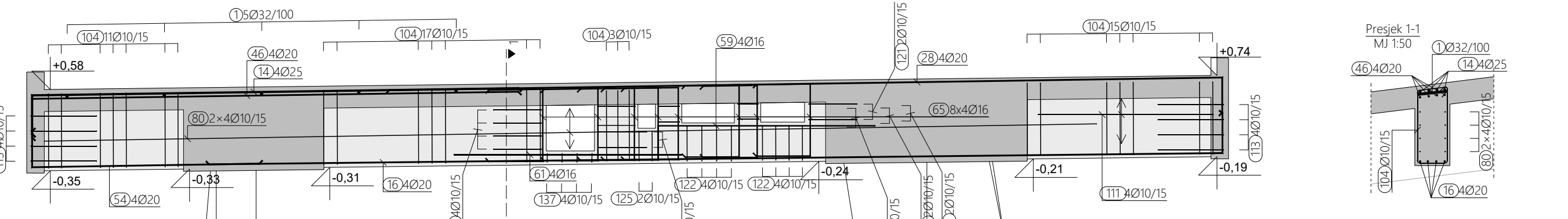

ARMATURA GREDE 3.3, M 1:50

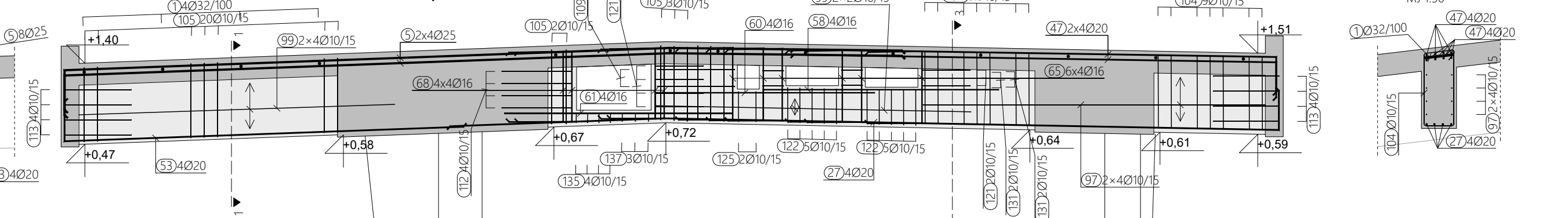

ARMATURA GREDE 3.4, M 1:50

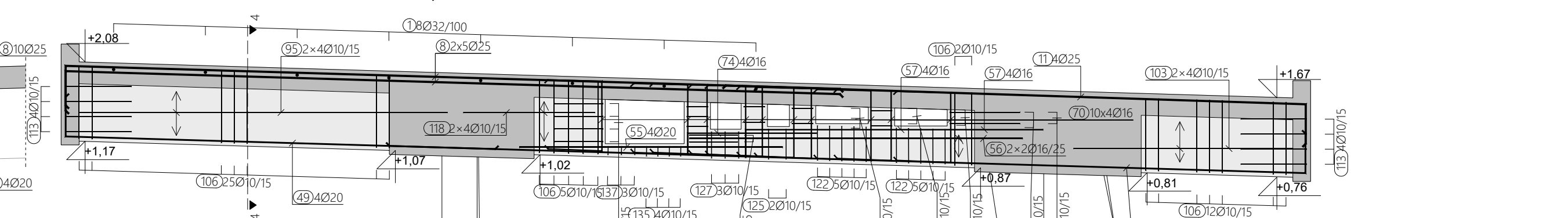

ARMATURA GREDE 3.5, M 1:50

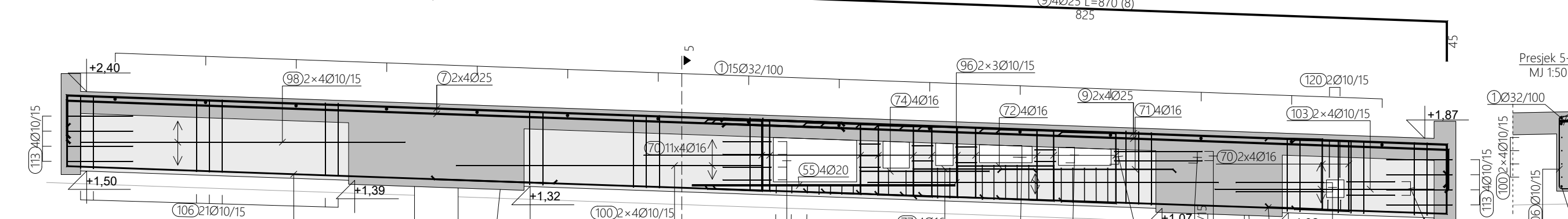

ARMATURA GREDE 3.6, M 1:50

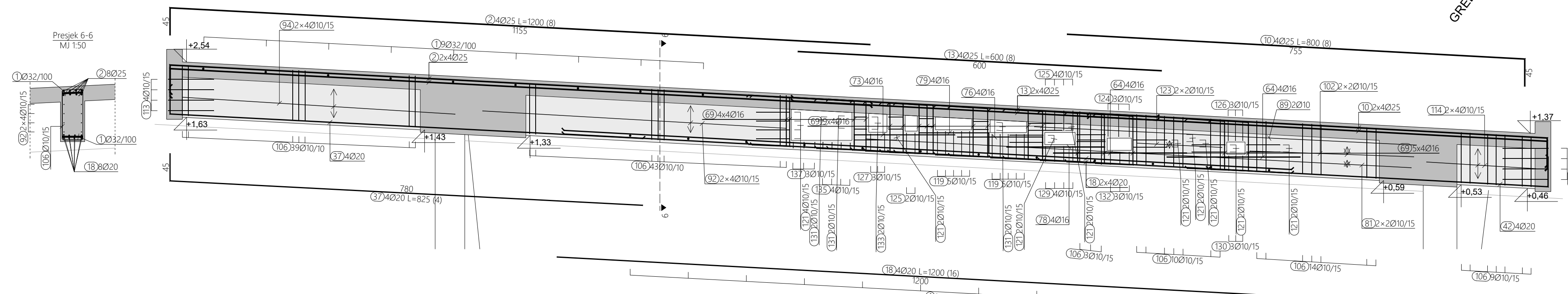

ARMATURA GREDE 3.19, M 1:50

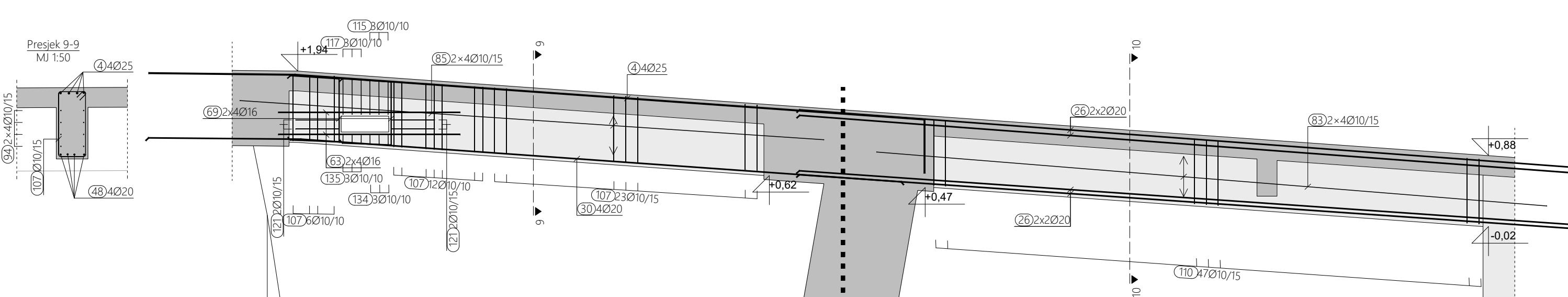

ARMATURA GREDE 3.20, M 1:50

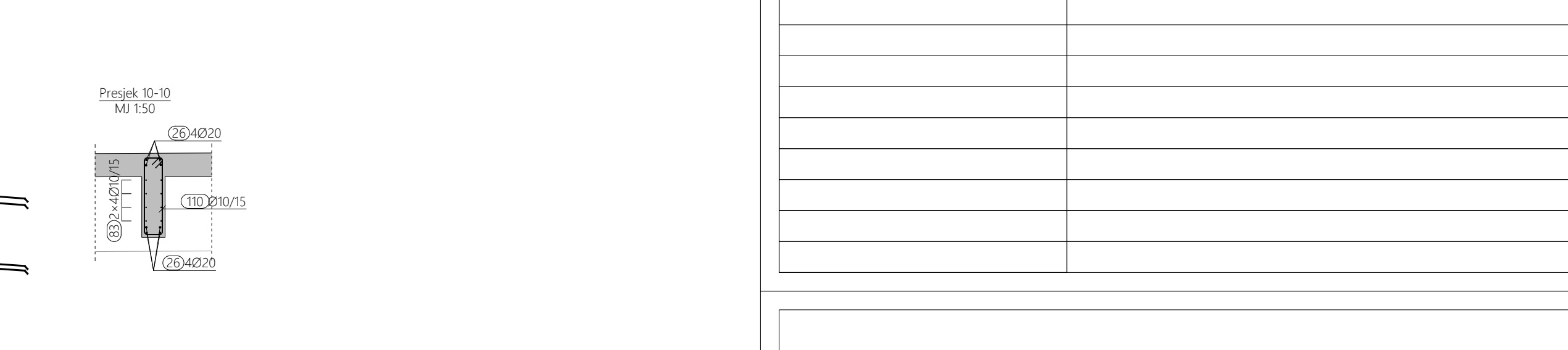

ARMATURA GREDE 3.14, M 1:50

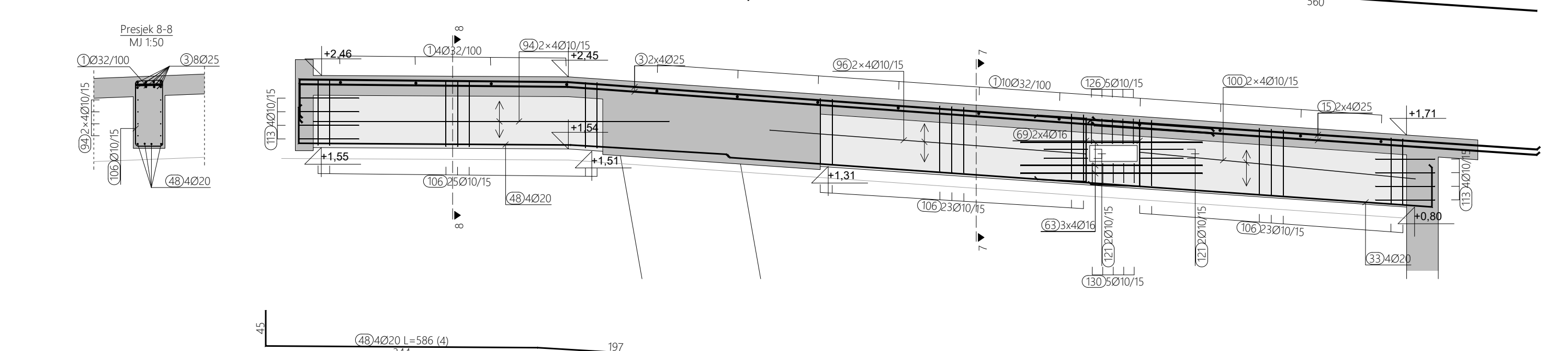

NAPOMENA
Šipke prilagoditi i po potrebi rezati na licu mjesta. Preklap 500.

NAPOMENA
Sve dimenzije provjeriti prema važećim planovima oplata.

Klasa betona	C 30/37
Armatura	B 500 B
Zaštitni sloj betona	
dole	3.0 cm
gore	3.0 cm
bočno	3.0 cm
Pripadajući armaturni nacrti	ARM_E-1_302-304

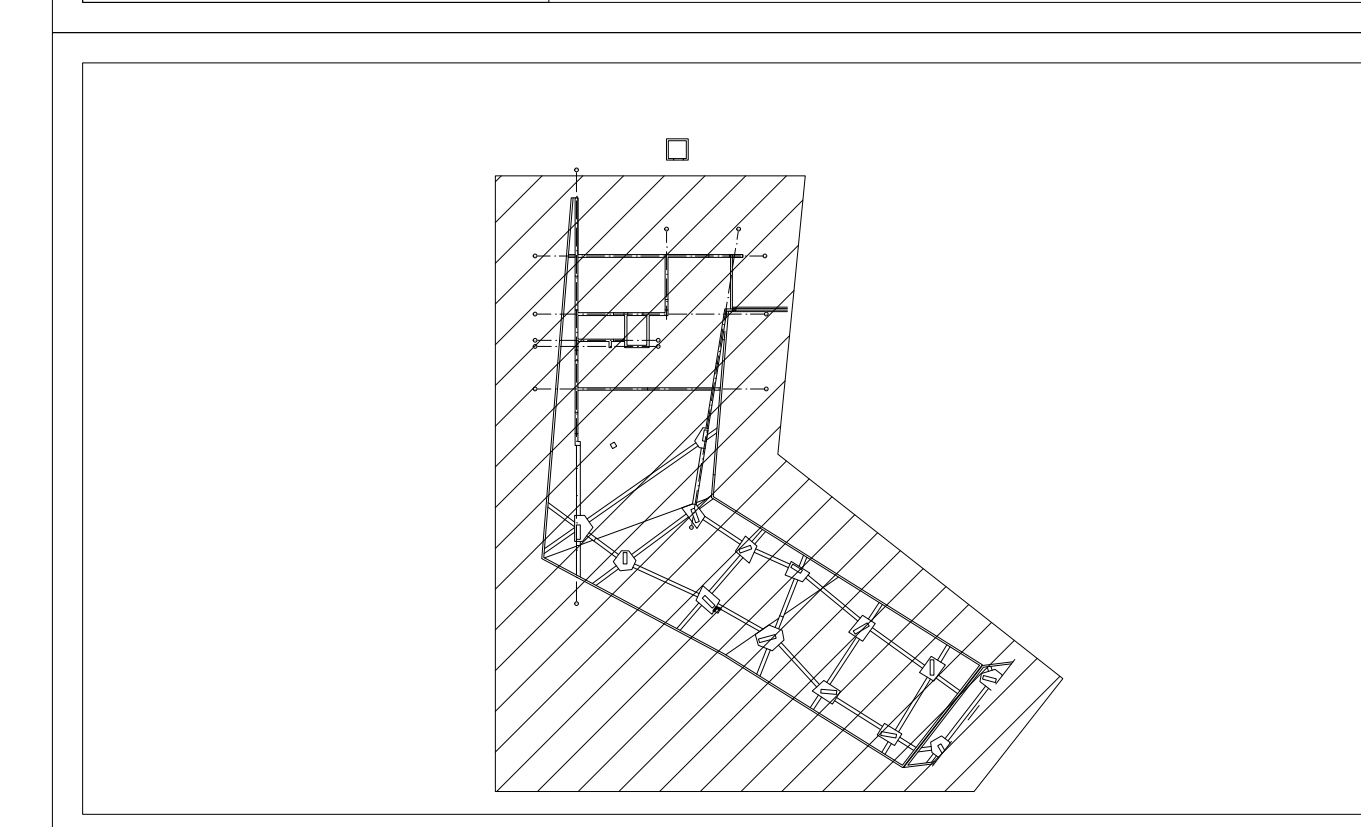

KONSTRUKTA PEČAT I POTPIŠ

KONSTRUKTA d.o.o., za projektiranje i nadzor
Desnovica 20, ZAGREB, OIB: 0667437879
ZR: PRIVREDNA BANKA 2340009-11016468
TEL: 01138 43 828; FAX: 01138 43 829
MAIL: info@konstrakta.hr

INVESTITOR: TERME Tuhelaš d.o.o. Ljudevit Gaj 4, Tuhelaš Toplice, 48215 Tuhela
GRAĐEVINA: REKONSTRUKCIJA TERMANANSKIH REKREACIJSKIH CENTARA TERME TUHELJA
LOKACIJA: na k.o.br. 3199/1, k.o. Črešnjevec
FAZA: IZVEDBENI PROJEKT - ARMATURNI NACRTI
SADRŽAJ: ELEMENT - DILATACIJA 3 ARMATURA STROPNE PLOČE E-1 GREDE E-1





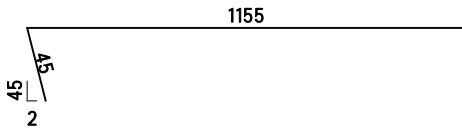
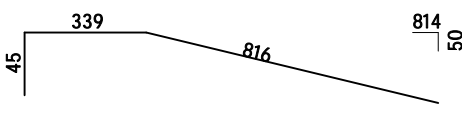
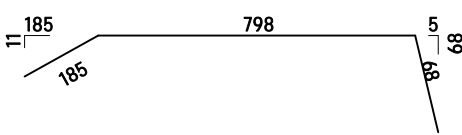
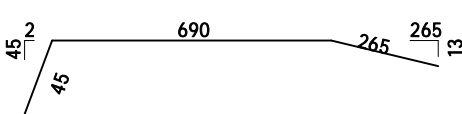
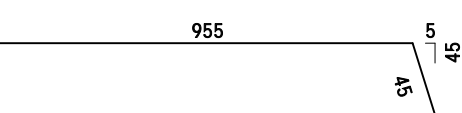
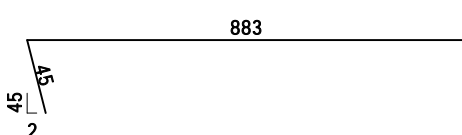
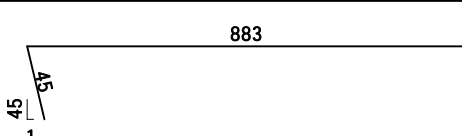
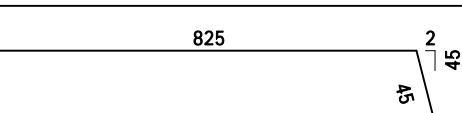
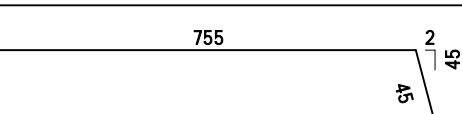
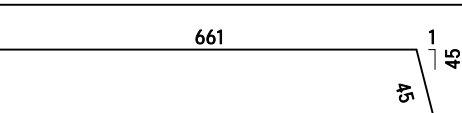

GL. PROJEKTANT: Tomislav Vrh, dipl. ing. arh.
PROJEKT. IZV. PR. Antonio Maglov, dipl. ing. građ.
IZRAĐIO: Antonio Maglov, dipl. ing. građ.DATUM: svibanj 2023.
MJEŠTO: 1:50 i 2:50
REVIZIJA: 00
NACRT BR.: ARM - E-1 - 301

ISKAZ ARMATURE		
GRAĐEVINA:	REKONSTRUKCIJA TERMALNOG REK. CENT. TERME TUHELJ	
ISKAZ UZ NACRT:	ARM- E-1_301	
SADRŽAJ:	ARMATURA GREDA STROPNE PLOČE -1	
DATUM:	24/06/2023	1/12

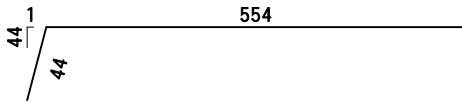
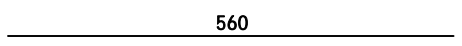
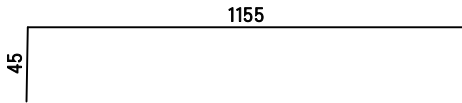
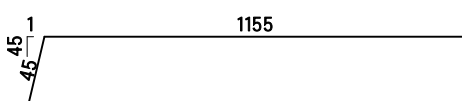
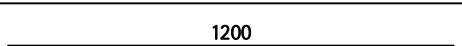
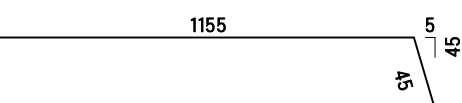
Šipke - specifikacija						
ozn	oblik i mjere [cm]	Ø	lg [m]	n [kom]	lgn [m]	Napomena
E-1_GREDE DIL 3 (1 kom)						
1	34	32	0.34	97	32.98	
2		25	12.00	8	96.00	
3		25	12.00	8	96.00	
4		25	10.51	4	42.04	
5		25	10.00	8	80.00	
6		25	10.00	4	40.00	
7		25	9.28	8	74.24	
8		25	9.28	10	92.80	
9		25	8.70	8	69.60	
10		25	8.00	8	64.00	
11		25	7.06	4	28.24	
12	620	25	6.20	4	24.80	
13	600	25	6.00	8	48.00	

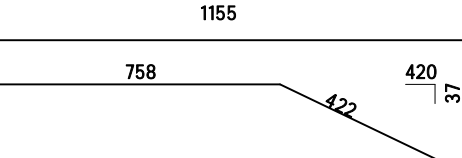
ISKAZ ARMATURE

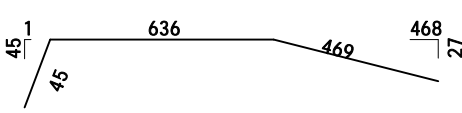
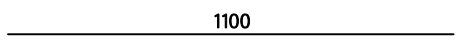
GRAĐEVINA:	REKONSTRUKCIJA TERMALNOG REK. CENT. TERME TUHELJ	
ISKAZ UZ NACRT:	ARM- E-1_301	
SADRŽAJ:	ARMATURA GREDA STROPNE PLOČE -1	
DATUM:	24/06/2023	2/12

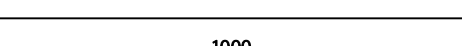
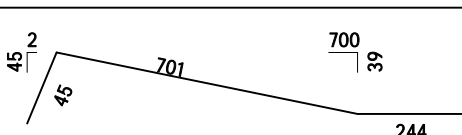
Šipke - specifikacija						
ozn	oblik i mjere [cm]	Ø	lg [m]	n [kom]	lgn [m]	Napomena
14		25	5.98	4	23.92	
15		25	5.60	8	44.80	
16		20	12.00	4	48.00	
17		20	12.00	4	48.00	
18		20	12.00	16	192.00	
19		20	12.00	4	48.00	
20		20	12.00	4	48.00	
21		20	11.80	8	94.40	
22		20	11.70	4	46.80	
23		20	11.50	4	46.00	
24		20	11.00	8	88.00	
25		20	10.90	4	43.60	
26		20	10.00	12	120.00	
27		20	9.90	4	39.60	



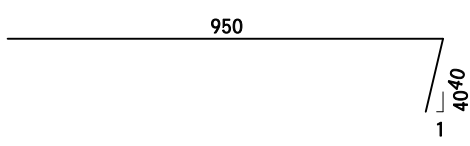
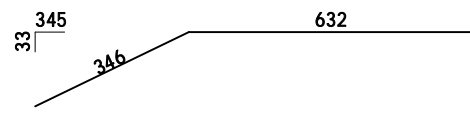
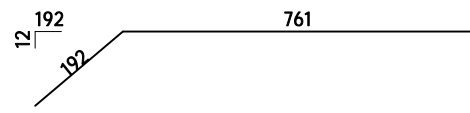
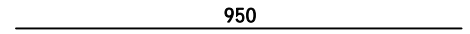
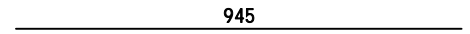
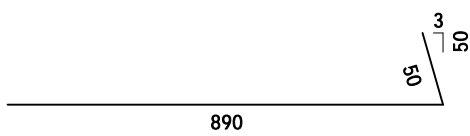
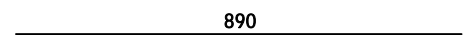
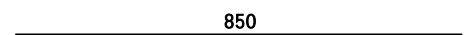
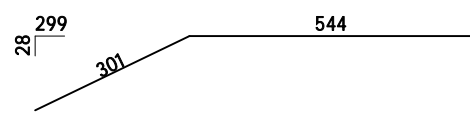
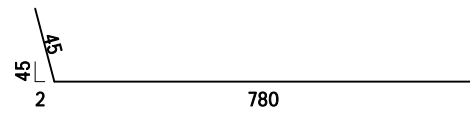
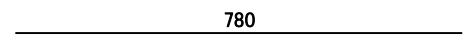
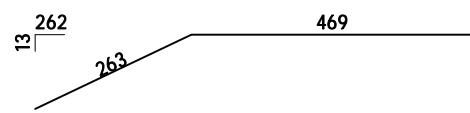
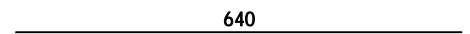
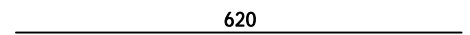
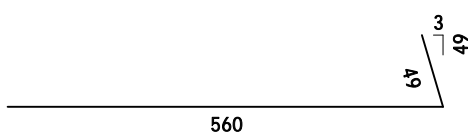
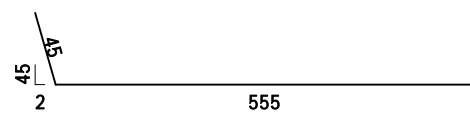

ISKAZ ARMATURE

GRAĐEVINA:	REKONSTRUKCIJA TERMALNOG REK. CENT. TERME TUHELJ	
ISKAZ UZ NACRT:	ARM- E-1_301	
SADRŽAJ:	ARMATURA GREDA STROPNE PLOČE -1	
DATUM:	24/06/2023	3/12



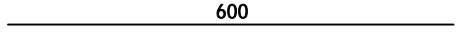
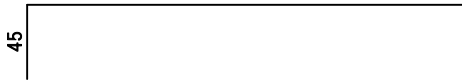
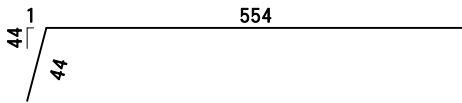
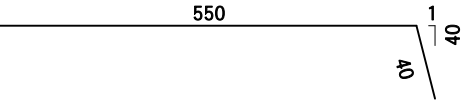
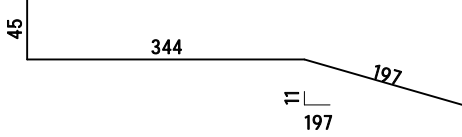
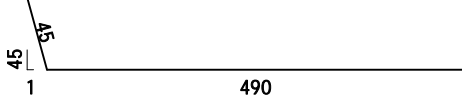

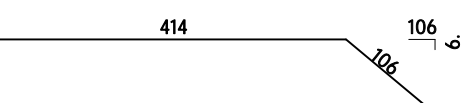
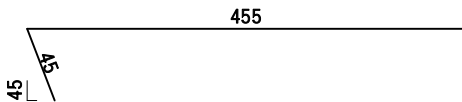
Šipke - specifikacija						
ozn	oblik i mjere [cm]	Ø	lg [m]	n [kom]	lgn [m]	Napomena
28		20	9.90	8	79.20	
29		20	9.78	5	48.90	
30		20	9.53	4	38.12	
31		20	9.50	4	38.00	
32		20	9.45	8	75.60	
33		20	9.40	4	37.60	
34		20	8.90	11	97.90	
35		20	8.50	4	34.00	
36		20	8.45	2	16.90	
37		20	8.25	4	33.00	
38		20	7.80	4	31.20	
39		20	7.32	4	29.28	
40		20	6.40	8	51.20	
41		20	6.20	4	24.80	
42		20	6.09	4	24.36	
43		20	6.00	4	24.00	

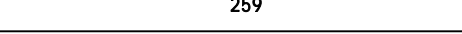
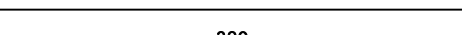
ISKAZ ARMATURE

GRAĐEVINA:	REKONSTRUKCIJA TERMALNOG REK. CENT. TERME TUHELJ	
ISKAZ UZ NACRT:	ARM- E-1_301	
SADRŽAJ:	ARMATURA GREDA STROPNE PLOČE -1	
DATUM:	24/06/2023	4/12

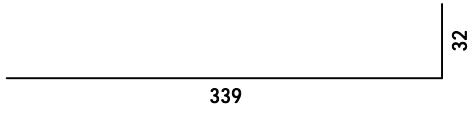
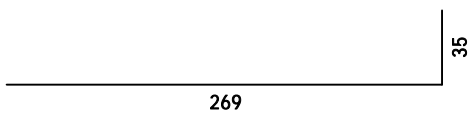
Šipke - specifikacija						
ozn	oblik i mjere [cm]	Ø	lg [m]	n [kom]	lgn [m]	Napomena
44		20	6.00	16	96.00	
45		20	6.00	8	48.00	
46		20	5.98	4	23.92	
47		20	5.90	8	47.20	
48		20	5.86	4	23.44	
49		20	5.35	4	21.40	
50		20	5.35	4	21.40	
51		20	5.20	4	20.80	
52		20	5.00	8	40.00	
53		20	5.00	4	20.00	
54		20	3.00	8	24.00	
55		20	3.00	8	24.00	
56		16	3.80	4	15.20	

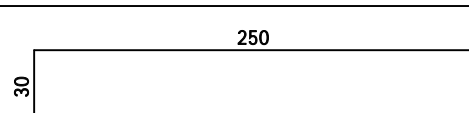
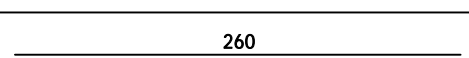
ISKAZ ARMATURE		
GRAĐEVINA:	REKONSTRUKCIJA TERMALNOG REK. CENT. TERME TUHELJ	
ISKAZ UZ NACRT:	ARM- E-1_301	
SADRŽAJ:	ARMATURA GREDA STROPNE PLOČE -1	
DATUM:	24/06/2023	5/12

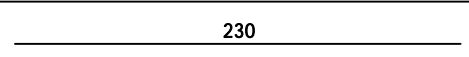
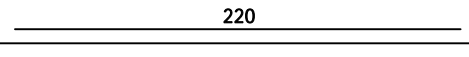
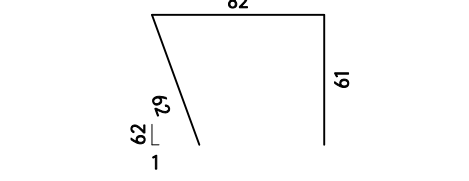
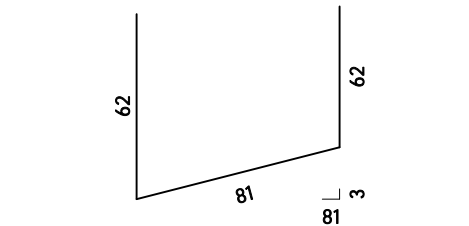
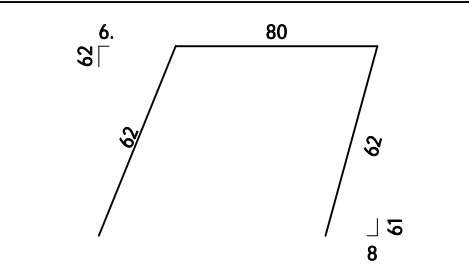
Šipke - specifikacija						
ozn	oblik i mjere [cm]	Ø	lg [m]	n [kom]	lgn [m]	Napomena
57		16	3.71	4	14.84	
58		16	3.04	4	12.16	
59		16	2.85	4	11.40	
60		16	2.80	4	11.20	
61		16	2.60	8	20.80	
62		16	2.49	4	9.96	
63		16	2.30	20	46.00	
64		16	2.20	88	193.60	
65		16	2.05	80	164.00	
66		16	2.05	64	131.20	
67		16	2.04	32	65.28	

ISKAZ ARMATURE		
GRAĐEVINA:	REKONSTRUKCIJA TERMALNOG REK. CENT. TERME TUHELJ	
ISKAZ UZ NACRT:	ARM- E-1_301	
SADRŽAJ:	ARMATURA GREDA STROPNE PLOČE -1	
DATUM:	24/06/2023	6/12

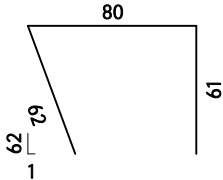
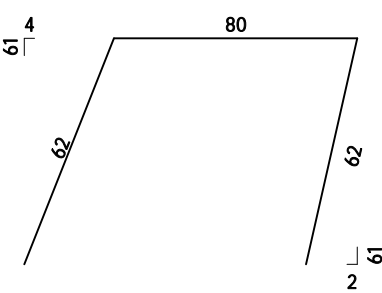
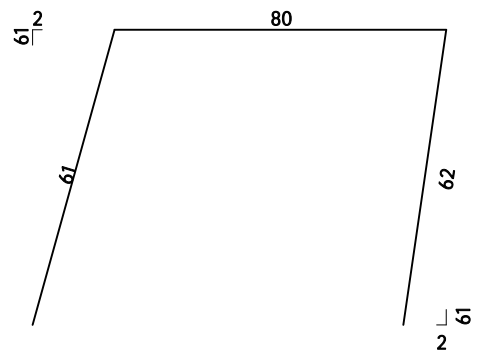
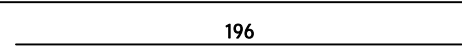
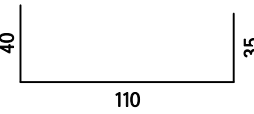
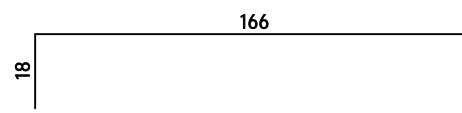
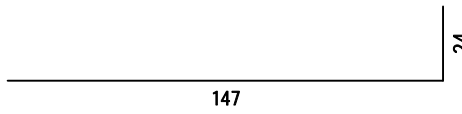
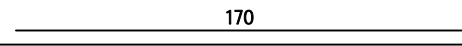
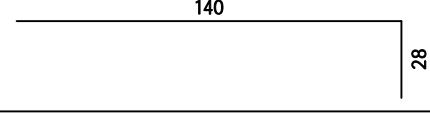
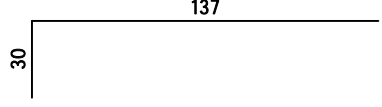
Šipke - specifikacija						
ozn	oblik i mjere [cm]	Ø	lg [m]	n [kom]	lgn [m]	Napomena
68		16	2.03	16	32.48	
69		16	2.04	88	179.52	
70		16	2.03	92	186.76	
71		16	1.96	4	7.84	
72		16	1.85	4	7.40	
73		16	1.84	4	7.36	
74		16	1.71	8	13.68	
75		16	1.70	20	34.00	
76		16	1.68	4	6.72	
77		16	1.67	4	6.68	

ISKAZ ARMATURE

GRAĐEVINA:	REKONSTRUKCIJA TERMALNOG REK. CENT. TERME TUHELJ		
ISKAZ UZ NACRT:	ARM- E-1_301		
SADRŽAJ:	ARMATURA GREDA STROPNE PLOČE -1		
DATUM:	24/06/2023		7/12

Šipke - specifikacija

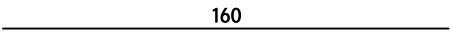
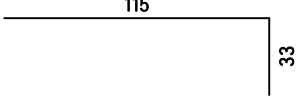
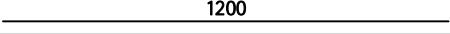
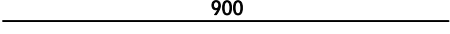
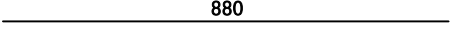
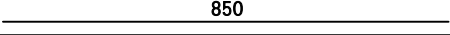
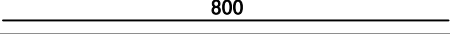
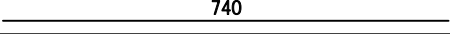
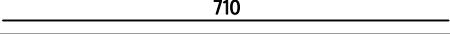
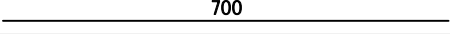
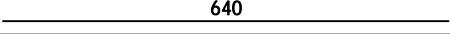
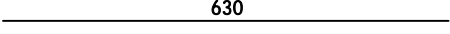
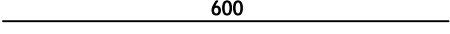
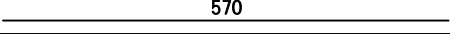
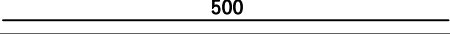
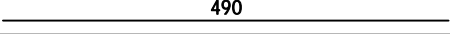
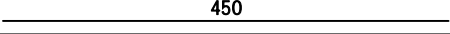
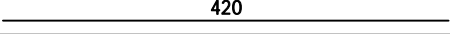
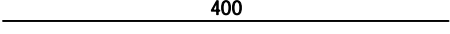
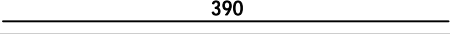
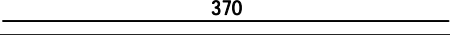
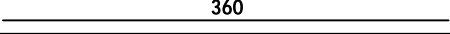
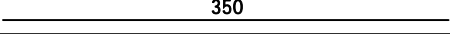
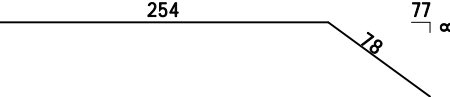
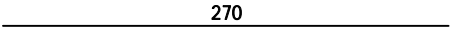
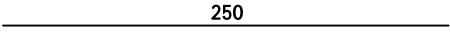
ozn	oblik i mjere [cm]	Ø	lg [m]	n [kom]	lgn [m]	Napomena
78		16	1.60	4	6.40	
79		16	1.48	4	5.92	
80		10	12.00	16	192.00	
81		10	9.00	4	36.00	
82		10	8.80	8	70.40	
83		10	8.50	8	68.00	
84		10	8.00	8	64.00	
85		10	7.40	8	59.20	
86		10	7.10	8	56.80	
87		10	7.00	8	56.00	
88		10	6.40	8	51.20	
89		10	6.30	2	12.60	
90		10	6.00	8	48.00	
91		10	5.70	8	45.60	
92		10	5.00	16	80.00	
93		10	4.90	8	39.20	
94		10	4.50	16	72.00	
95		10	4.20	8	33.60	
96		10	4.00	22	88.00	
97		10	3.90	8	31.20	
98		10	3.70	8	29.60	
99		10	3.60	12	43.20	
100		10	3.50	26	91.00	
101		10	3.32	8	26.56	
102		10	2.70	14	37.80	
103		10	2.50	16	40.00	

ISKAZ ARMATURE

GRAĐEVINA:	REKONSTRUKCIJA TERMALNOG REK. CENT. TERME TUHELJ	
ISKAZ UZ NACRT:	ARM- E-1_301	
SADRŽAJ:	ARMATURA GREDA STROPNE PLOČE -1	
DATUM:	24/06/2023	8/12

Šipke - specifikacija

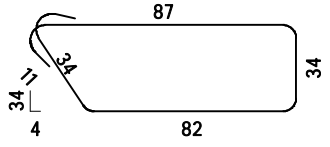
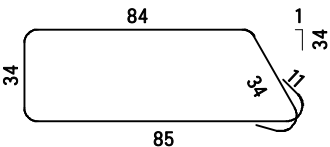
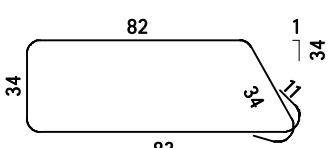
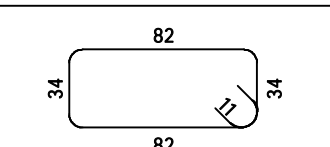
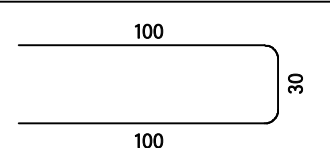
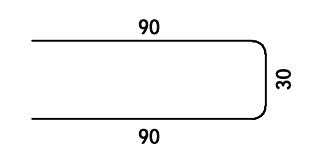
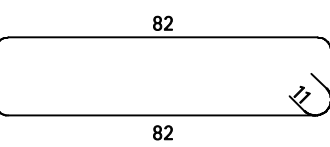
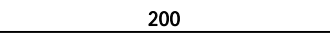
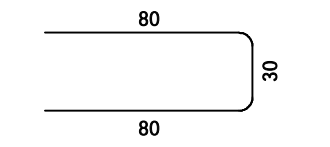
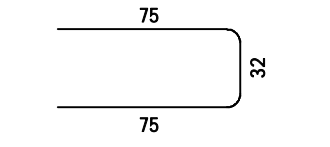
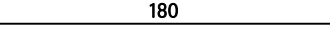
ozn	oblik i mjere [cm]	Ø	lg [m]	n [kom]	lgn [m]	Napomena
104		10	2.59	122	315.98	
105		10	2.59	25	64.75	
106		10	2.55	644	1642.20	
107		10	2.54	41	104.14	
108		10	2.30	4	9.20	
109		10	2.10	2	4.20	
110		10	2.24	47	105.28	
111		10	2.00	8	16.00	
112		10	1.90	6	11.40	
113		10	1.82	68	123.76	
114		10	1.80	8	14.40	

ISKAZ ARMATURE

GRAĐEVINA:	REKONSTRUKCIJA TERMALNOG REK. CENT. TERME TUHELJ	
ISKAZ UZ NACRT:	ARM- E-1_301	
SADRŽAJ:	ARMATURA GREDA STROPNE PLOČE -1	
DATUM:	24/06/2023	9/12

Šipke - specifikacija						
ozn	oblik i mjere [cm]	Ø	lg [m]	n [kom]	lgn [m]	Napomena
115		10	1.80	3	5.40	
116		10	1.74	2	3.48	
117		10	1.74	3	5.22	
118		10	1.50	8	12.00	
119		10	1.70	20	34.00	
120		10	1.70	2	3.40	
121		10	1.42	104	147.68	
122		10	1.64	35	57.40	
123		10	1.40	4	5.60	
124		10	1.62	3	4.86	
125		10	1.58	16	25.28	

ISKAZ ARMATURE

GRAĐEVINA:	REKONSTRUKCIJA TERMALNOG REK. CENT. TERME TUHELJ	
ISKAZ UZ NACRT:	ARM- E-1_301	
SADRŽAJ:	ARMATURA GREDA STROPNE PLOČE -1	
DATUM:	24/06/2023	10/12

Šipke - specifikacija

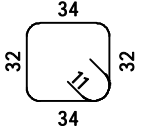
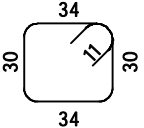
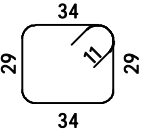
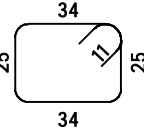
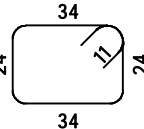
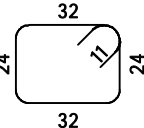
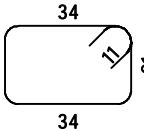
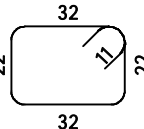
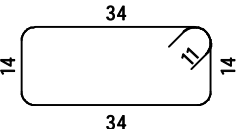
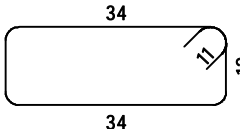
ozn	oblik i mjere [cm]	Ø	lg [m]	n [kom]	lgn [m]	Napomena
126		10	1.54	52	80.08	
127		10	1.50	16	24.00	
128		10	1.48	8	11.84	
129		10	1.40	4	5.60	
130		10	1.38	52	71.76	
131		10	1.34	36	48.24	
132		10	1.32	3	3.96	
133		10	1.30	2	2.60	
134		10	1.18	3	3.54	
135		10	1.14	19	21.66	

ISKAZ ARMATURE	
GRAĐEVINA:	REKONSTRUKCIJA TERMALNOG REK. CENT. TERME TUHELJ
ISKAZ UZ NACRT:	ARM- E-1_301
SADRŽAJ:	ARMATURA GREDA STROPNE PLOČE -1
DATUM:	24/06/2023
	11/12

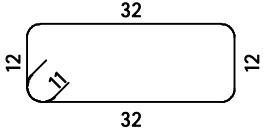
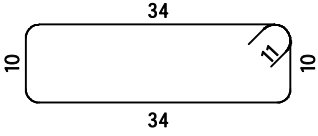
Šipke - specifikacija						
ozn	oblik i mjere [cm]	Ø	lg [m]	n [kom]	lgn [m]	Napomena
136		10	1.10	2	2.20	
137		10	1.10	16	17.60	

ISKAZ ARMATURE		
GRAĐEVINA:	REKONSTRUKCIJA TERMALNOG REK. CENT. TERME TUHELJ	
ISKAZ UZ NACRT:	ARM- E-1_301	
SADRŽAJ:	ARMATURA GREDA STROPNE PLOČE -1	
DATUM:	24/06/2023	12/12

Šipke - rekapitulacija			
Ø [mm]	lgn [m]	Jedinična težina [kg/m ³]	Težina [kg]
B500B			
10	4380.67	0.62	2702.87
16	1190.40	1.58	1880.83
20	1956.62	2.47	4832.85
25	824.44	3.85	3174.09
32	32.98	6.31	208.10
Ukupno (B500B)			12798.75
Ukupno			12798.75

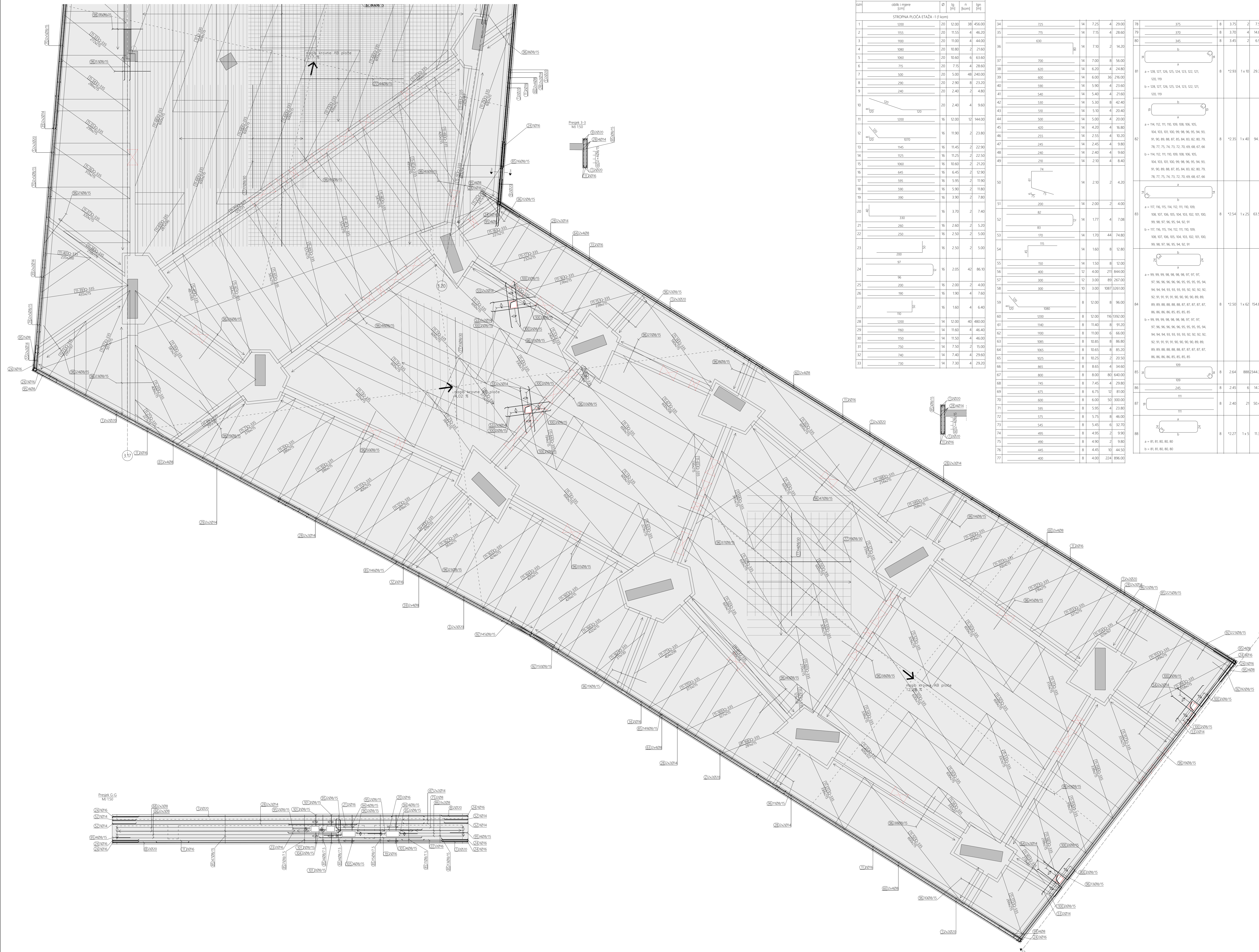

Sipke - specifikacija

ozn.	dužina [m]	Ø [mm]	l [m]	n [kom]	ozn.	l [m]	n [kom]	ozn.			
STROPA PLOČA ETAŽE -1 (11kom)											
1	1500	20	12,00	38	456,00	34	725	14	7,25	4	29,00
2	1555	20	11,55	4	46,20	35	775	14	7,75	4	29,60
3	1300	20	11,00	4	44,00	36	830	14	7,10	2	14,20
4	1380	20	10,80	2	21,60	37	790	14	7,00	8	56,00
5	1060	20	10,60	6	63,60	38	620	14	6,20	4	24,80
6	715	20	7,15	4	28,60	39	690	14	6,90	36	248,40
7	500	20	5,00	48	240,00	40	590	14	5,90	4	23,60
8	290	20	2,90	8	23,20	41	540	14	5,40	4	21,60
9	240	20	2,40	2	4,80	42	530	14	5,30	8	42,40
10						43	510	14	5,10	4	20,40
11	1000	16	12,00	12	144,00	44	500	14	5,00	4	20,00
12						45	420	14	4,20	4	16,80
13	1145	16	11,45	2	22,90	46	255	14	2,55	4	9,80
14	1155	16	11,55	2	23,50	47	245	14	2,45	4	9,00
15	1060	16	10,60	2	21,20	48	240	14	2,40	4	9,60
16	645	16	6,45	2	12,90	49	210	14	2,10	4	8,40
17	595	16	5,95	2	11,90	50					
18	590	16	5,90	2	11,80	51	200	14	2,00	2	4,00
19	390	16	3,90	2	7,80	52	82	14	1,77	4	7,08
20						53	85	14	1,70	44	74,80
21	330	16	3,30	2	6,60	54	150	14	1,50	8	12,00
22	260	16	2,60	2	5,20	55	150	14	1,50	8	12,00
23	250	16	2,50	2	5,00	56	400	12	4,00	211	844,00
24	200	16	2,00	40	80,00	57	350	12	3,50	89	307,00
25	200	16	2,00	2	4,00	58	300	10	3,00	1087	3261,00
26	190	16	1,90	4	7,60	59					
27	110	16	1,60	4	6,40	60	1200	8	12,00	716	1192,00
28	1200	14	12,00	40	480,00	61	740	8	7,40	8	91,20
29	1300	14	13,00	4	52,00	62	720	8	7,20	4	66,00
30	1350	14	13,50	4	54,00	63	700	8	7,00	8	84,00
31	750	14	7,50	2	15,00	64	680	8	6,80	8	86,40
32	740	14	7,40	4	29,60	65	660	8	6,60	8	88,80
33	730	14	7,30	4	29,20	66	640	8	6,40	8	91,20
						67	620	8	6,20	8	94,40
						68	600	8	6,00	80	480,00
						69	580	8	5,80	12	69,60
						70	560	8	5,60	50	300,00
						71	540	8	5,40	4	21,60
						72	520	8	5,20	8	41,60
						73	500	8	5,00	6	30,00
						74	480	8	4,80	2	9,60
						75	460	8	4,60	2	9,20
						76	440	8	4,40	10	44,00
						77	420	8	4,20	224	896,00

78	375	8	3,75	2	7,50
79	375	8	3,70	4	14,80
80	345	8	3,45	2	6,90
81	a = 108, 127, 126, 125, 124, 123, 122, 121, 120, 119	8	*2,99	1 x 10	29,90
82	a = 114, 112, 111, 110, 108, 106, 105, 104, 103, 101, 100, 99, 98, 96, 95, 94, 93, 91, 90, 88, 87, 85, 84, 83, 82, 80, 79, 78, 77, 75, 74, 73, 72, 70, 69, 68, 67, 66, 104, 103, 101, 100, 98, 96, 95, 94, 93, 91, 90, 88, 87, 85, 84, 83, 82, 80, 79, 78, 77, 75, 74, 73, 72, 70, 69, 68, 67, 66	8	*2,35	1 x 40	94,10
83	a = 117, 116, 115, 114, 112, 111, 110, 108, 107, 106, 105, 104, 103, 102, 101, 100, 99, 98, 97, 96, 95, 94, 92, 91, 90, 89, 87, 86, 85, 84, 83, 82, 80, 79, 78, 77, 75, 74, 73, 72, 70, 69, 68, 67, 66	8	*2,54	1 x 25	63,54
84	a = 99, 98, 96, 94, 93, 92, 91, 90, 89, 87, 86, 85, 84, 83, 82, 80, 79, 78, 77, 75, 74, 73, 72, 70, 69, 68, 67, 66, 88, 88, 88, 88, 87, 87, 87, 87, 87, 86, 86, 86, 85, 85, 85, 85	8	*2,50	1 x 62	154,84
85	a = 109	8	2,64	888	2444,32
86	a = 109	8	2,45	6	14,70
87	a = 109	8	2,40	21	50,40
88	a = 81, 81, 80, 80, 80	8	*2,27	1 x 5	11,34
89	99	8	2,44	96	2342,4
90	99	8	2,05	2	4,10
91	a = 67, 69	8	*1,81	1 x 2	3,62
92	73	8	1,60	110	1814,80
93	71	8	1,60	13	20,80
94	69	8	1,60	8	12,80
95	67	8	1,45	66	95,70
96	64	8	1,40	972	1365,60
97	63	8	1,35	4	5,40
98	62	8	1,20	422	506,40
99	61	8	1,20	39	46,80
100	60	8	1,20	52	62,40
101	59	8	1,20	8	10,00
102	58	8	1,05	1780	1869,00
103	57	8	0,94	2	1,88
104	56	8	0,90	2	1,80
105	55	8	0,86	8	6,88

NAPOMENA
Sipke prilagoditi i po potrebi rezi na licu mjesta. Preklap 500.

NAPOMENA
Sve dimenzije provjeriti prema važećim planovima oplata.

Klasa betona	C 30/37		
Armatura	B 500 B		
Zaštitni sloj betona	Pripadajuća klasa armature		
doje	gore	bočno	ARM_E-1_302-305_ISKAZ
3,0 cm	3,0 cm	3,0 cm	
Pripadajući armaturni nacrti			
ARM_E-1_301_303-305_306			
ARM_E-2_321			

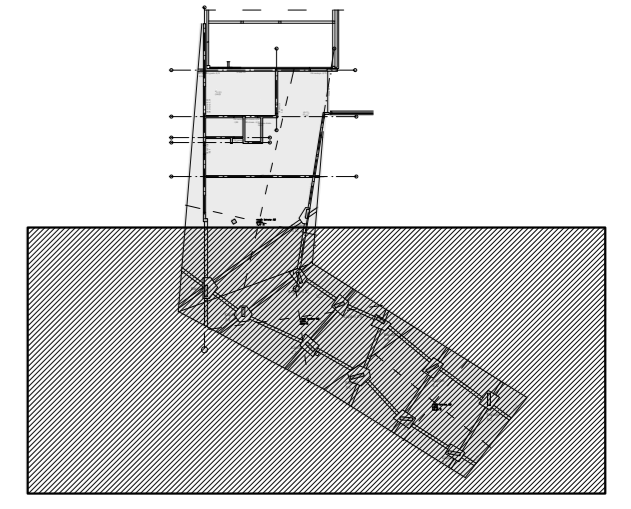

KONSTRUKTA PEČAT I POTPIŠ

KONSTRUKTA d.o.o., za projektiranje i nadzor
Bavarska 26, ZAGREB, OIB: 0667437879
ZR: PRIVREDNA BANKA 2340009-1110164468
TEL: 01136 43 829; FAX: 01136 43 829
MAIL: info@konstrukt.hr

INVESTITOR: TERME Tuhelj i d.o.o. Laskovca Cigla 4, Tuheljske Toplice, 48115 Tuhelj

GRADJEVINA: REKONSTRUKCIJA TERMANOG BERRADSKOG OPIŠTA TERMA Tuhelj

LOKACIJA: na k.c.izp. 3199/1, k.o. Črednjevec

FAZA: IZVEDBENI PROJEKT - ARMATURNI NACRTI

SAKONZ: ELEMENT - PLOČA E-1
DILATACIJA 3
RUBNA ARMATURA I DONJA ZONA 1/2

GL. PROJEKTANT: Tomislav Vrh, dipl. ing. arh.

PROJEKT (OV. PR): Antonio Maglov, dipl. ing. grad.

GRADIVO: ANTONIO MAGLOV, dipl. ing. grad.

DATUM: srpanj 2023.

MJERILO: 1:50

REVIZIJA: 00

NACRT BR: **ARM - E-1 - 302**

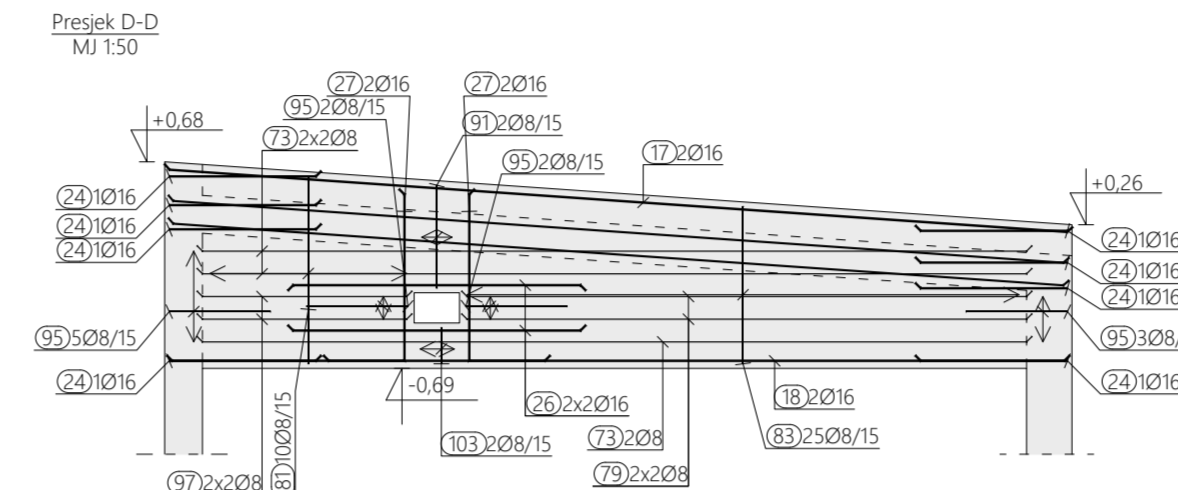
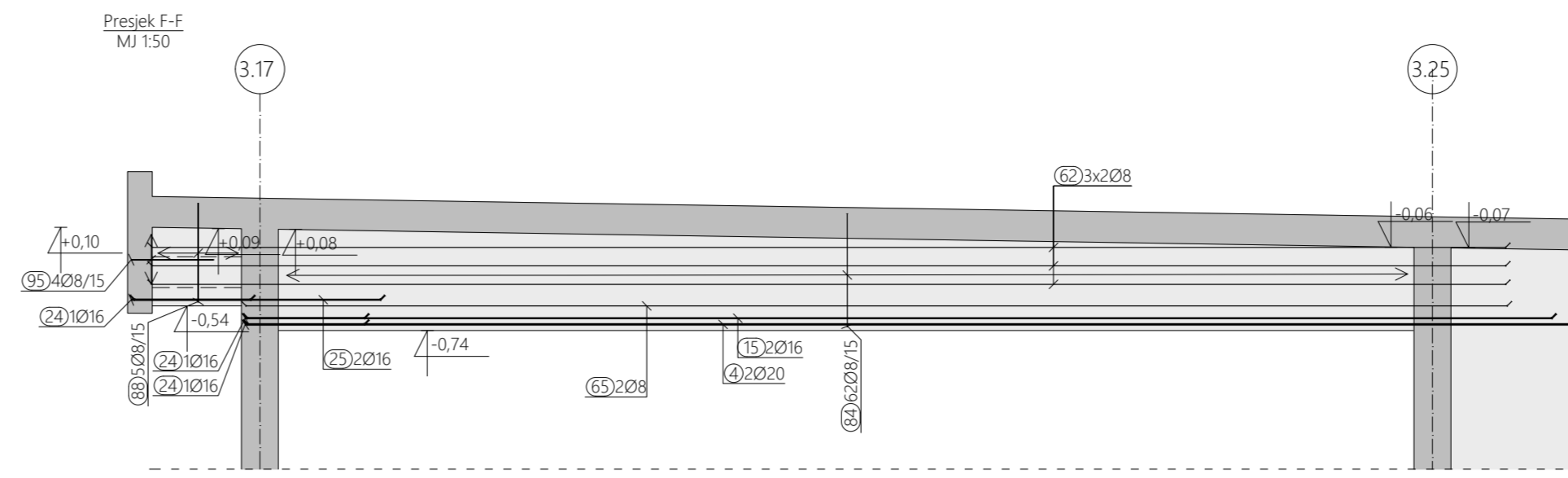
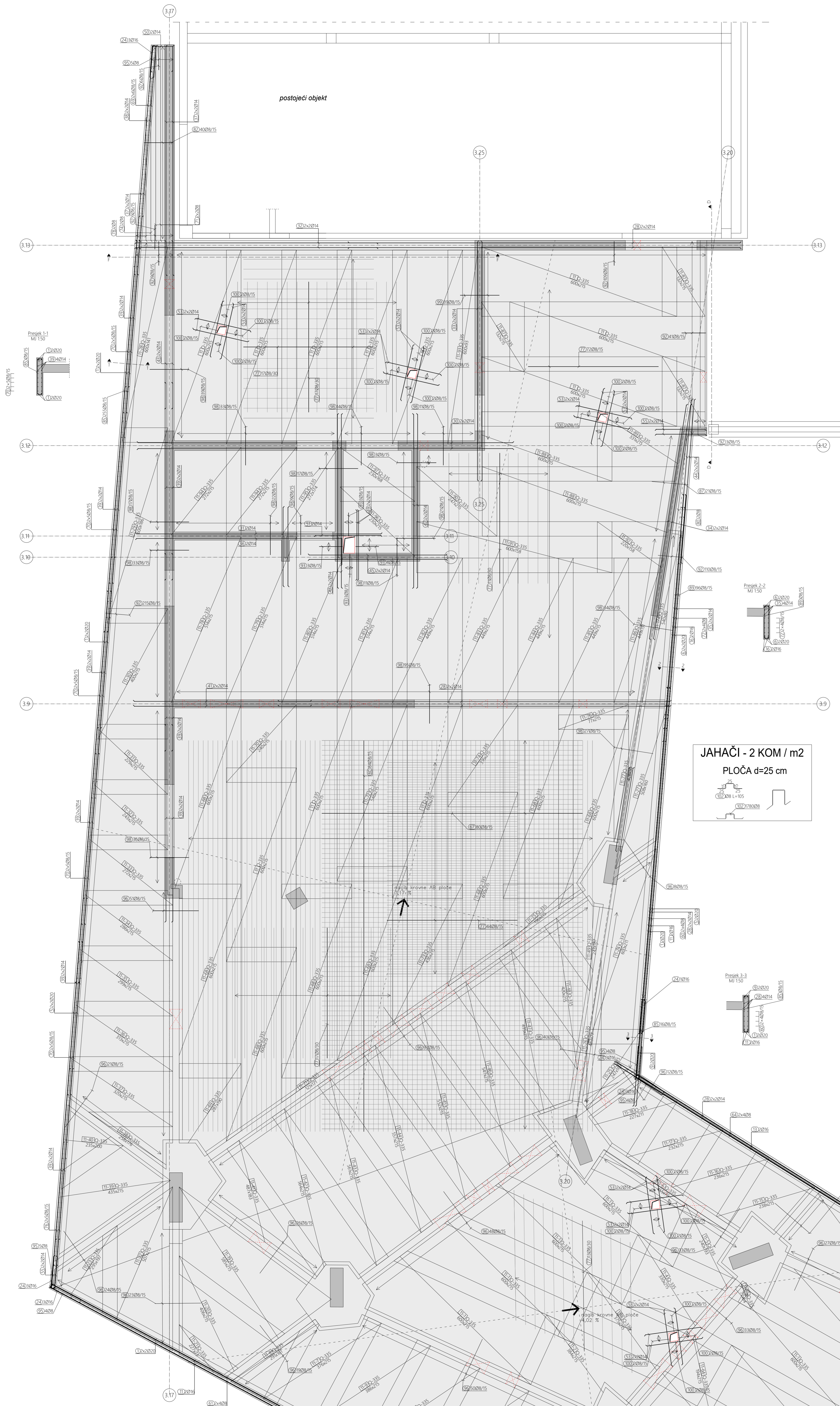

Sipke - specifikacija	oznaka	dimenzije (mm)	l (m)	n (kom)	g (kg)
STROPNA PLOČA ETAŽE -1 (1 kom)					
1	1000	20 12 00	38	454,00	
2	155	20 11 55	4	46,20	
3	1000	20 11 00	4	44,00	
4	1000	20 10 80	2	21,60	
5	1000	20 10 60	6	63,60	
6	775	20 7 15	4	28,60	
7	500	20 5 00	48	240,00	
8	290	20 2 90	8	23,20	
9	240	20 2 40	2	4,80	
10		20 2 40	4	9,60	
11	1000	16 12 00	12	144,00	
12		16 11 90	2	23,80	
13	1000	16 11 45	2	23,90	
14	1000	16 11 25	2	22,50	
15	1000	16 10 60	2	21,20	
16	645	16 6 45	2	12,90	
17	595	16 5 95	2	11,90	
18	590	16 5 90	2	11,80	
19	390	16 3 90	2	7,80	
20		16 3 70	2	7,40	
21	280	16 2 80	2	5,20	
22	290	16 2 90	2	5,00	
23	200	16 2 50	2	5,00	
24	97	16 2 05	42	86,10	
25	96	16 2 00	2	4,00	
26	900	16 1 90	4	7,60	
27		16 1 60	4	6,40	
28	1000	14 12 00	40	480,00	
29	1000	14 11 60	4	46,40	
30	1000	14 11 50	4	46,00	
31	750	14 7 50	2	15,00	
32	740	14 7 40	4	29,60	
33	730	14 7 30	4	29,20	
34	720	14 7 25	4	29,00	
35	710	14 7 15	4	28,60	
36	630	14 7 10	2	14,20	
37	700	14 7 00	8	56,00	
38	620	14 6 20	4	24,80	
39	600	14 6 00	36	216,00	
40	590	14 5 90	4	23,60	
41	540	14 5 40	4	21,60	
42	530	14 5 30	8	42,40	
43	510	14 5 10	4	20,40	
44	500	14 5 00	4	20,00	
45	420	14 4 20	4	16,80	
46	370	14 3 70	4	14,80	
47	245	14 2 45	4	9,80	
48	240	14 2 40	4	9,60	
49	230	14 2 30	4	8,40	
50		14 2 10	2	4,20	
51	200	14 2 00	2	4,00	
52	82	14 1 77	4	7,08	
53	120	14 1 70	44	74,80	
54	105	14 1 60	8	12,80	
55	90	14 1 50	8	12,00	
56	800	12 4 00	216	864,00	
57	800	12 3 00	89	267,00	
58	800	10 3 00	108	324,00	
59		8 12 00	8	96,00	
60	1000	8 12 00	116	1160,00	
61	1000	8 11 40	8	80,00	
62	1000	8 11 00	6	66,00	
63	1000	8 10 85	8	86,80	
64	1000	8 10 65	8	85,20	
65	1000	8 10 25	2	20,50	
66	885	8 8 65	4	34,60	
67	800	8 8 00	80	640,00	
68	745	8 7 45	4	29,80	
69	675	8 6 75	12	81,00	
70	600	8 6 00	50	300,00	
71	595	8 5 95	4	23,80	
72	575	8 5 75	8	46,00	
73	545	8 5 45	6	32,70	
74	495	8 4 95	2	9,90	
75	490	8 4 90	2	9,80	
76	485	8 4 85	10	44,50	
77	480	8 4 80	40	224,00	
78	375	8 3 75	2	7,50	
79	370	8 3 70	4	14,80	

80	345	8	3 45	2	6 90
81		8	12 90	1 x 10	29 30
82		8	12 50	1 x 40	94 85
83		8	12 54	1 x 25	63 54
84		8	12 50	1 x 62	154 84
85	339	8	2 64	880	344 32
86	245	8	2 45	6	14 70
87	111	8	2 40	2	50 40
88		8	12 27	1 x 5	11 34
89	397	8	2 44	96	234 24
90	187	8	2 05	2	4 10
91		8	11 81	1 x 2	3 62
92	73	8	1 65	110	834 85
93	71	8	1 60	11	20 80
94	60	8	1 65	8	13 28
95	67	8	1 45	66	95 70
96	330	8	1 40	970	1360 80
97	135	8	1 35	4	3 40
98	130	8	1 20	420	556 40
99	130	8	1 20	39	46 80
100	51	8	1 20	52	62 40
101	40	8	1 25	8	10 38
102	25	8	1 05	1780	869 00
103	24	8	0 94	2	1 88
104	24	8	0 90	2	1 80
105	20	8	0 86	6	6 88

NAPOMENA
Sipke prilagoditi i po potrebi rezati na licu mjesta. Preklap 500.

NAPOMENA
Sve dimenzije provjeriti prema važećim planovima optate.

Klasa betona	C 30/37
Zaštitni sloj betona	B 500 B
debljina	3,0 cm
gustoća	3,0 cm
Prilagodljivi armaturni nacrti	ARM_E-2_203_1SKAZ
ARM_E-1_301_302_304-305_306	
ARM_E-2_321	

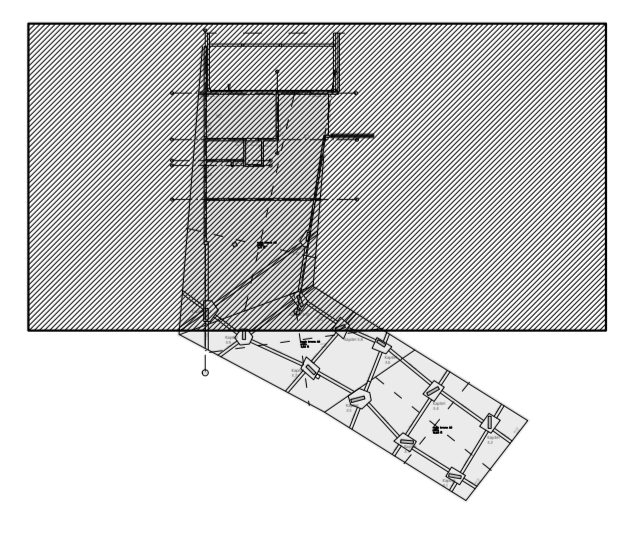

KONSTRUKTA PEČAT I POTPIS

KONSTRUKTA d.o.o., za projektiranje i nadzor
Desnička 20, ZAGREB, OIB: 0667437879
ZB: PROJEKCIJSKA BILANCA 2340008-1110164468
TEL: 01326 43 828; FAX: 01326 43 829
MAIL: info@konstrukt.hr

GL. PROJEKTANT: Tomislav Vekić, dipl. ing. arh.
PROJEKT. OS. VSE: Adriano Maguš, dipl. ing. grad.
IZRADIO: Adriano Maguš, dipl. ing. grad.

na k.c.b.r. 3199/1, k.o. Črešnjevac
IZVEDENI PROJEKT - ARMATURNI NACRTI
ELEMENT - PLOČA E-1
DILATACIJA 3
RUBNA ARMATURA I DONJA ZONA 2/2

DATUM: 09.09.2023.
MJERLO: 1:50
REVIZIJA: 00

NACRT BR: **ARM - E - 1 - 303**

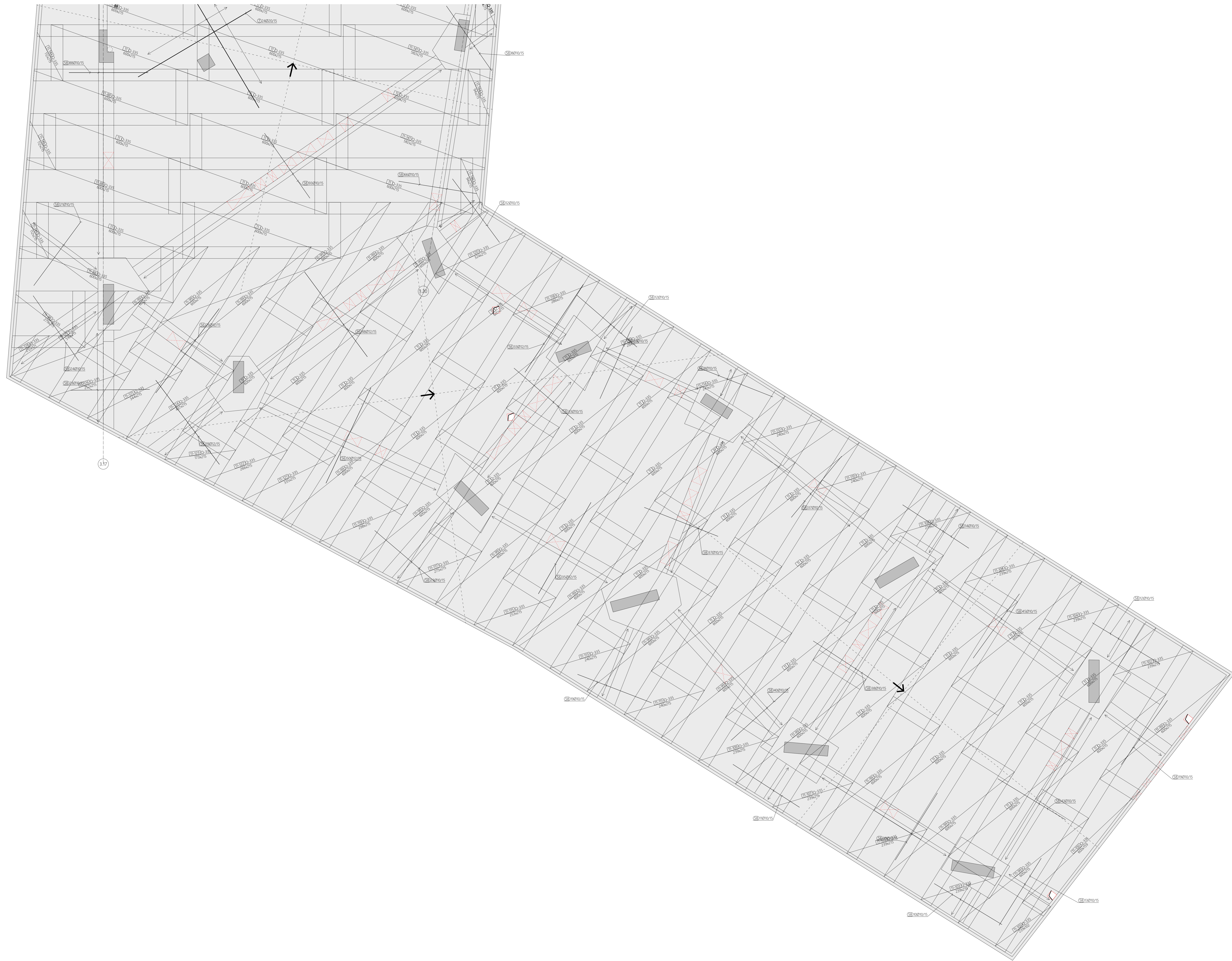

NAPOMENA
 Šipke prilagoditi i po potrebi rezati na licu mjesta. Preklap 500.

NAPOMENA
 Sve dimenzije provjeriti prema važećim planovima oplata.

Klasa betona	C 30/37		
Armatura	B 500 B		
Zaštitni sloj betona			
dole	gore	bočno	Pripadajuća klasa armature
3,0 cm	3,0 cm	3,0 cm	ARM_E-1_302-305_ISKAZ
Pripadajući armaturni nacrti			
ARM_E-1_301_302-303_305_306			
ARM_E-2_321			

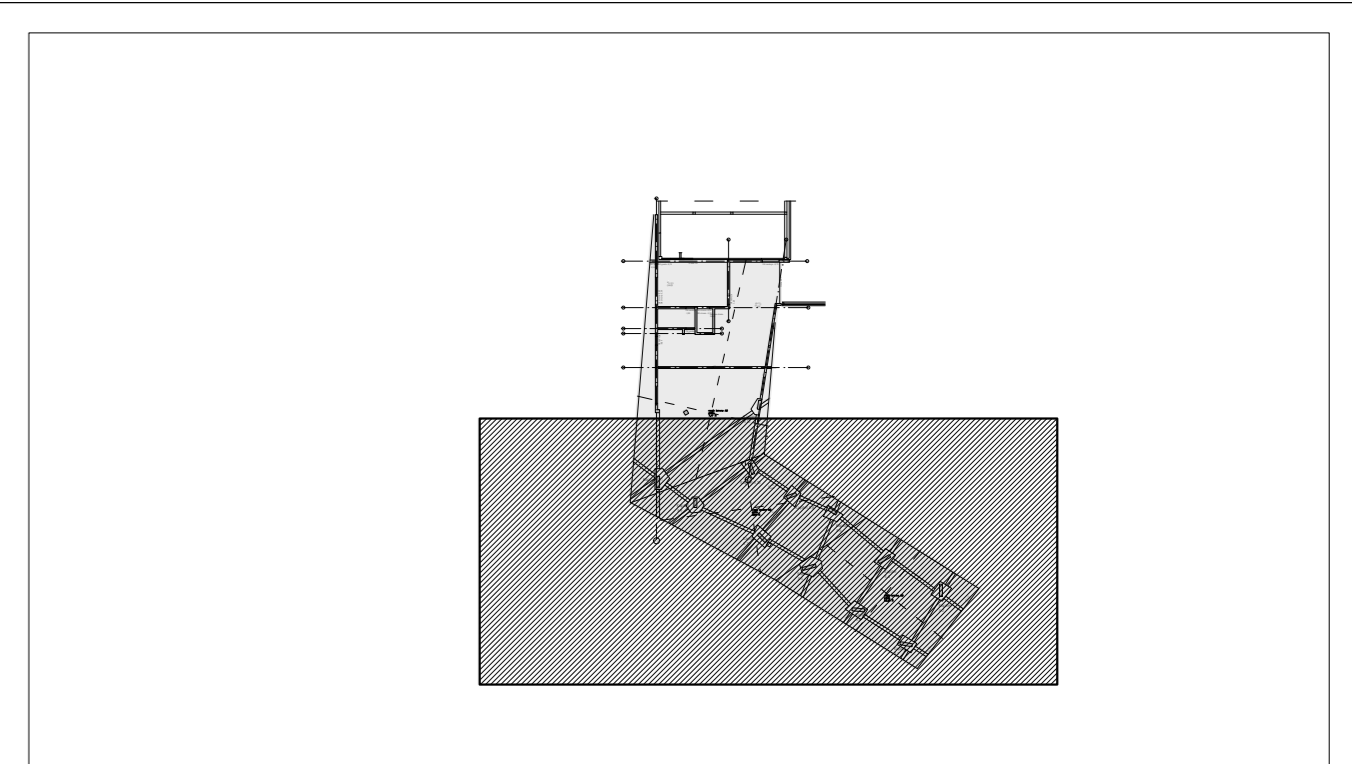

KONSTRUKTA PEČAT I POTPIS:



KONSTRUKTA d.o.o., za projektiranje i nadzor
 Desnovička 26, ZAGREB, OIB: 6667437679
 ŽR: PRIVREDNA BANKA 2340009-1110164468
 TEL: 0136 43 828; FAX: 0136 43 829
 MAIL: info@konstrukt.hr

IZVOD: 001
 DIO: 001
 LIST: 001

INVESTITOR: TERME TUNJEVI d.o.o. Laskovka Giga 4, Tunjevske Toplice, 48115 Tunjevi
 GRAĐEVINA: REKONSTRUKCIJA TERMANOGOR BERAČKOSKOJ OPIŠTA TERME TUNJEVI
 LOKACIJA: na k.c.izp. 3199/1, k.o. Čredšćevac
 FAZA: IZVODENI PROJEKT - ARMATURNI NACRTI
 SADRŽAJ: ELEMENT - PLOČA E-1
 DILATACIJA 3
 ARMATURA GORNJE ZONE 1/2

GL. PROJEKTANT: Tomislav Vrdel, dipl. ing. arh.
 PROJEKT (OV. PR.): Antonio Maglov, dipl. ing. grad.
 IZRADO: Antonio Maglov, dipl. ing. grad.
 DATUM: septem. 2023.
 MJESECILO: 150
 REVIZIJA: 00
 NACRT BR: **ARM - E-1 - 304**

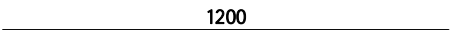
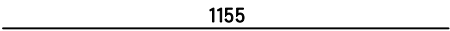
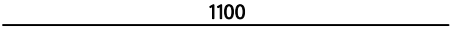
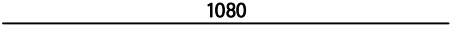
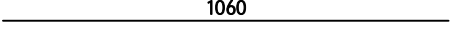
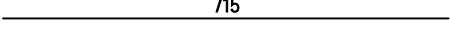
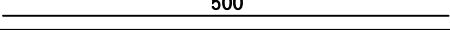
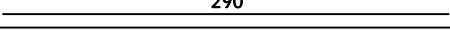
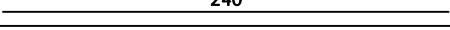
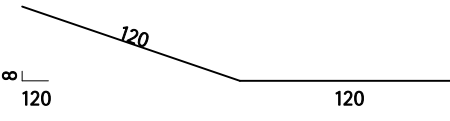
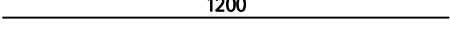
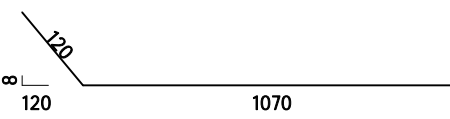
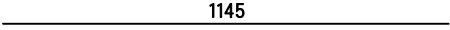
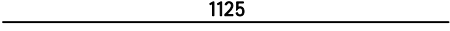
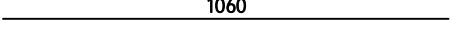
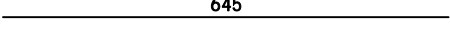
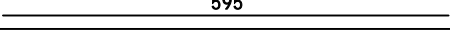
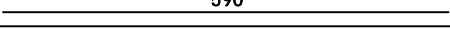
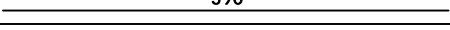
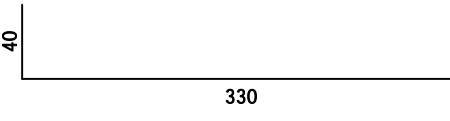
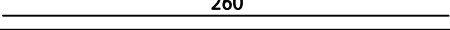
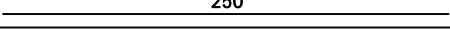





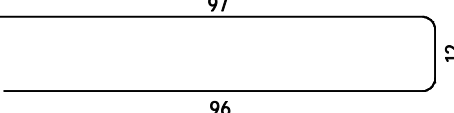
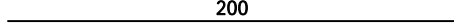
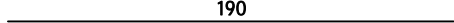
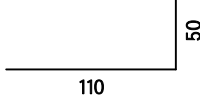
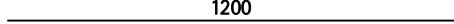
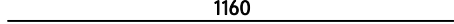
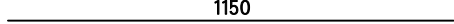
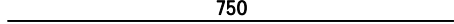
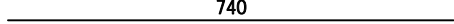
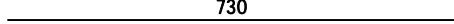
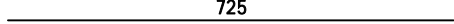
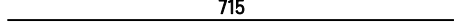
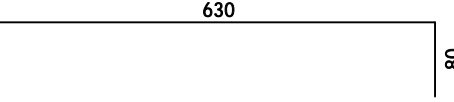
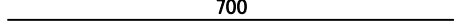
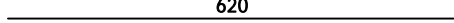
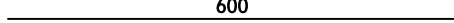
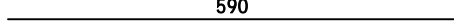
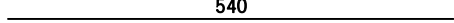
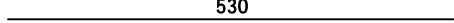
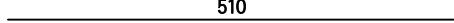
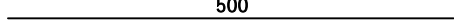
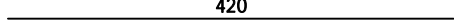
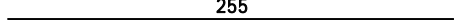
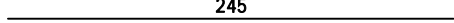
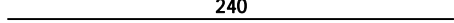
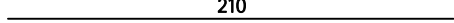

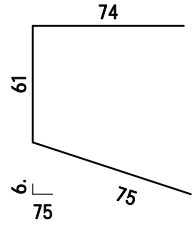
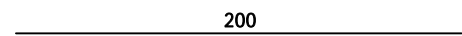
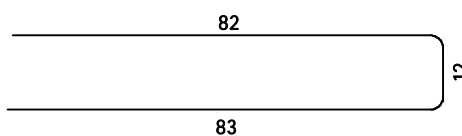
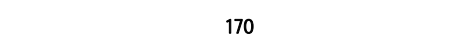
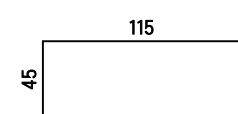

ISKAZ ARMATURE	
GRAĐEVINA:	REKONSTRUKCIJA TERMALNOG REKREACIJSKOG CENTRA TERME TUHELJ
ISKAZ UZ NACRT:	E-1_302-305_0
SADRŽAJ:	ARMATURA STROPNE PLOČE ETAŽA -1
DATUM:	srpanj, 2023.

Šipke - specifikacija						
ozn	oblik i mjere [cm]	Ø	lg [m]	n [kom]	lgn [m]	Napomena
STROPNA PLOČA ETAŽA -1 (1 kom)						
1		20	12.00	38	456.00	
2		20	11.55	4	46.20	
3		20	11.00	4	44.00	
4		20	10.80	2	21.60	
5		20	10.60	6	63.60	
6		20	7.15	4	28.60	
7		20	5.00	48	240.00	
8		20	2.90	8	23.20	
9		20	2.40	2	4.80	
10		20	2.40	4	9.60	
11		16	12.00	12	144.00	
12		16	11.90	2	23.80	
13		16	11.45	2	22.90	
14		16	11.25	2	22.50	
15		16	10.60	2	21.20	
16		16	6.45	2	12.90	
17		16	5.95	2	11.90	
18		16	5.90	2	11.80	
19		16	3.90	2	7.80	
20		16	3.70	2	7.40	
21		16	2.60	2	5.20	
22		16	2.50	2	5.00	
23		16	2.50	2	5.00	

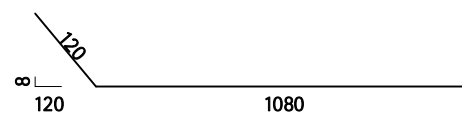
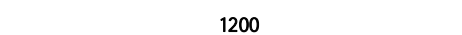
ISKAZ ARMATURE	
GRAĐEVINA:	REKONSTRUKCIJA TERMALNOG REKREACIJSKOG CENTRA TERME TUHELJ
ISKAZ UZ NACRT:	E-1_302-305_0
SADRŽAJ:	ARMATURA STROPNE PLOČE ETAŽA -1
DATUM:	srpanj, 2023.

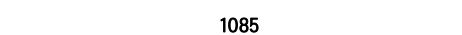
Šipke - specifikacija						
ozn	oblik i mjere [cm]	Ø	lg [m]	n [kom]	lgn [m]	Napomena
24		16	2.05	42	86.10	
25		16	2.00	2	4.00	
26		16	1.90	4	7.60	
27		16	1.60	4	6.40	
28		14	12.00	40	480.00	
29		14	11.60	4	46.40	
30		14	11.50	4	46.00	
31		14	7.50	2	15.00	
32		14	7.40	4	29.60	
33		14	7.30	4	29.20	
34		14	7.25	4	29.00	
35		14	7.15	4	28.60	
36		14	7.10	2	14.20	
37		14	7.00	8	56.00	
38		14	6.20	4	24.80	
39		14	6.00	36	216.00	
40		14	5.90	4	23.60	
41		14	5.40	4	21.60	
42		14	5.30	8	42.40	
43		14	5.10	4	20.40	
44		14	5.00	4	20.00	
45		14	4.20	4	16.80	
46		14	2.55	4	10.20	
47		14	2.45	4	9.80	
48		14	2.40	4	9.60	
49		14	2.10	4	8.40	

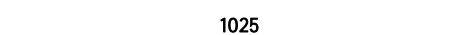
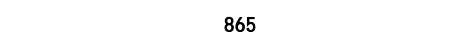
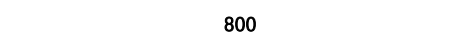
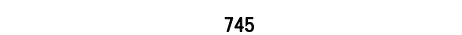
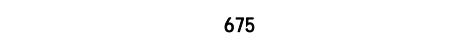
ISKAZ ARMATURE	
GRAĐEVINA:	REKONSTRUKCIJA TERMALNOG REKREACIJSKOG CENTRA TERME TUHELJ
ISKAZ UZ NACRT:	E-1_302-305_0
SADRŽAJ:	ARMATURA STROPNE PLOČE ETAŽA -1
DATUM:	srpanj, 2023.

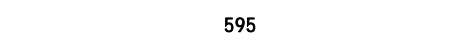
Šipke - specifikacija						
ozn	oblik i mjere [cm]	Ø	lg [m]	n [kom]	lgn [m]	Napomena
50		14	2.10	2	4.20	
51		14	2.00	2	4.00	
52		14	1.77	4	7.08	
53		14	1.70	44	74.80	
54		14	1.60	8	12.80	
55		14	1.50	8	12.00	
56		12	4.00	211	844.00	
57		12	3.00	89	267.00	
58		10	3.00	1087	3261.00	
59		8	12.00	8	96.00	
60		8	12.00	116	1392.00	
61		8	11.40	8	91.20	
62		8	11.00	6	66.00	
63		8	10.85	8	86.80	
64		8	10.65	8	85.20	
65		8	10.25	2	20.50	
66		8	8.65	4	34.60	
67		8	8.00	80	640.00	
68		8	7.45	4	29.80	
69		8	6.75	12	81.00	
70		8	6.00	50	300.00	
71		8	5.95	4	23.80	

ISKAZ ARMATURE	
GRAĐEVINA:	REKONSTRUKCIJA TERMALNOG REKREACIJSKOG CENTRA TERME TUHELJ
ISKAZ UZ NACRT:	E-1_302-305_0
SADRŽAJ:	ARMATURA STROPNE PLOČE ETAŽA -1
DATUM:	srpanj, 2023.

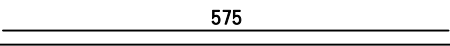
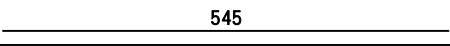
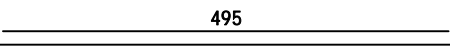
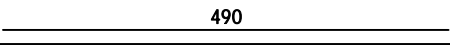
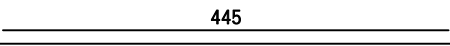
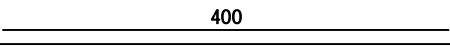
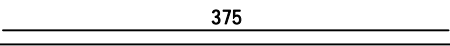
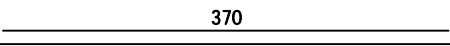
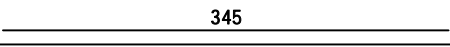
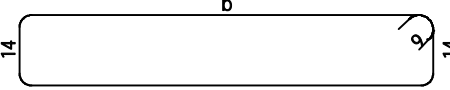
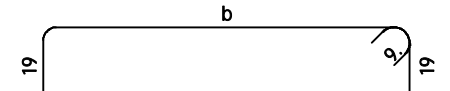
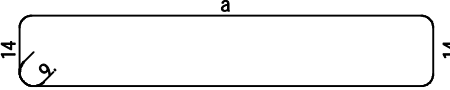
Šipke - specifikacija						
ozn	oblik i mjere [cm]	Ø	lg [m]	n [kom]	lgn [m]	Napomena
72	 575	8	5.75	8	46.00	
73	 545	8	5.45	6	32.70	
74	 495	8	4.95	2	9.90	
75	 490	8	4.90	2	9.80	
76	 445	8	4.45	10	44.50	
77	 400	8	4.00	224	896.00	
78	 375	8	3.75	2	7.50	
79	 370	8	3.70	4	14.80	
80	 345	8	3.45	2	6.90	
81	 <p>a = 128, 127, 126, 125, 124, 123, 122, 121, 120, 119 b = 128, 127, 126, 125, 124, 123, 122, 121, 120, 119</p>	8	*2.93	1 x 10	29.30	
82	 <p>a = 114, 112, 111, 110, 109, 108, 106, 105, 104, 103, 101, 100, 99, 98, 96, 95, 94, 93, 91, 90, 89, 88, 87, 85, 84, 83, 82, 80, 79, 78, 77, 75, 74, 73, 72, 70, 69, 68, 67, 66 b = 114, 112, 111, 110, 109, 108, 106, 105, 104, 103, 101, 100, 99, 98, 96, 95, 94, 93, 91, 90, 89, 88, 87, 85, 84, 83, 82, 80, 79, 78, 77, 75, 74, 73, 72, 70, 69, 68, 67, 66</p>	8	*2.35	1 x 40	94.10	
83	 <p>a = 117, 116, 115, 114, 112, 111, 110, 109, 108, 107, 106, 105, 104, 103, 102, 101, 100, 99, 98, 97, 96, 95, 94, 92, 91 b = 117, 116, 115, 114, 112, 111, 110, 109, 108, 107, 106, 105, 104, 103, 102, 101, 100, 99, 98, 97, 96, 95, 94, 92, 91</p>	8	*2.54	1 x 25	63.54	

ISKAZ ARMATURE

GRAĐEVINA:	REKONSTRUKCIJA TERMALNOG REKREACIJSKOG CENTRA TERME TUHELJ
ISKAZ UZ NACRT:	E-1_302-305_0
SADRŽAJ:	ARMATURA STROPNE PLOČE ETAŽA -1
DATUM:	srpanj, 2023.

Šipke - specifikacija

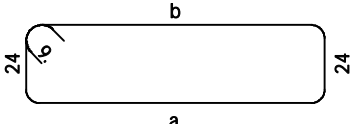
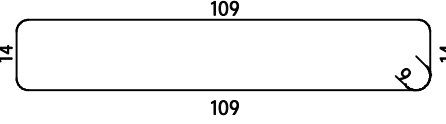
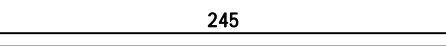
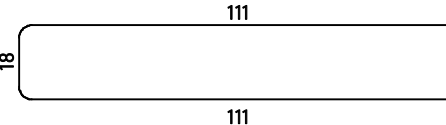
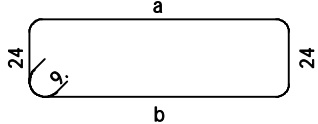
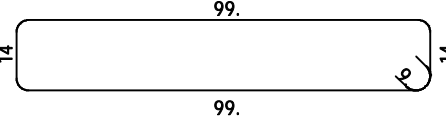
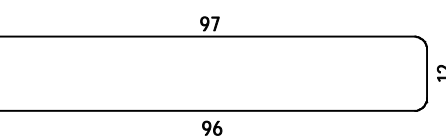
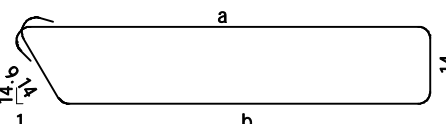
ozn	oblik i mjere [cm]	Ø	lg [m]	n [kom]	lgn [m]	Napomena
84	 <p>a = 99, 99, 99, 98, 98, 98, 98, 97, 97, 97, 97, 96, 96, 96, 96, 95, 95, 95, 95, 94, 94, 94, 94, 93, 93, 93, 93, 92, 92, 92, 92, 92, 91, 91, 91, 91, 90, 90, 90, 90, 89, 89, 89, 89, 88, 88, 88, 88, 87, 87, 87, 87, 87, 86, 86, 86, 86, 85, 85, 85, 85</p> <p>b = 99, 99, 99, 98, 98, 98, 98, 97, 97, 97, 97, 96, 96, 96, 96, 95, 95, 95, 95, 94, 94, 94, 94, 93, 93, 93, 93, 92, 92, 92, 92, 92, 91, 91, 91, 91, 90, 90, 90, 90, 89, 89, 89, 89, 88, 88, 88, 88, 87, 87, 87, 87, 87, 86, 86, 86, 86, 85, 85, 85, 85</p>	8	*2.50	1 x 62	154.84	
85		8	2.64	888	2344.32	
86		8	2.45	6	14.70	
87		8	2.40	21	50.40	
88	 <p>a = 81, 81, 80, 80, 80</p> <p>b = 81, 81, 80, 80, 80</p>	8	*2.27	1 x 5	11.34	
89		8	2.44	96	234.24	
90		8	2.05	2	4.10	
91	 <p>a = 67, 69</p> <p>b = 66, 68</p>	8	*1.81	1 x 2	3.62	

ISKAZ ARMATURE

GRAĐEVINA:	REKONSTRUKCIJA TERMALNOG REKREACIJSKOG CENTRA TERME TUHELJ
ISKAZ UZ NACRT:	E-1_302-305_0
SADRŽAJ:	ARMATURA STROPNE PLOČE ETAŽA -1
DATUM:	srpanj, 2023.

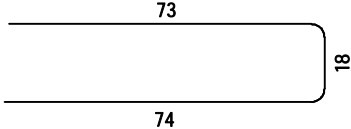
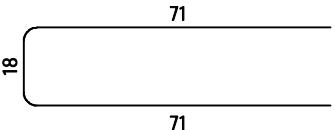
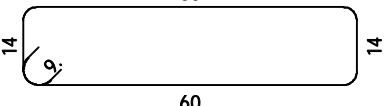
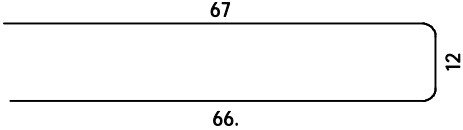
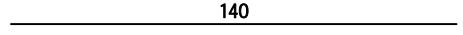
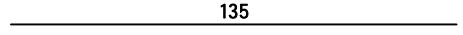
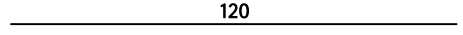
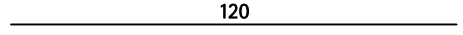
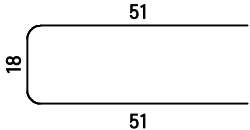
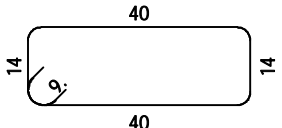
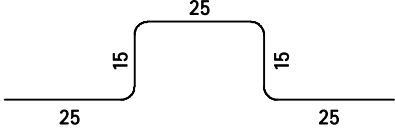
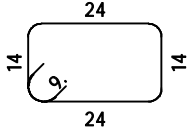
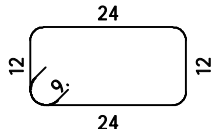
Šipke - specifikacija						
ozn	oblik i mjere [cm]	Ø	lg [m]	n [kom]	lgn [m]	Napomena
92		8	1.65	1112	1834.80	
93		8	1.60	13	20.80	
94		8	1.66	8	13.28	
95		8	1.45	66	95.70	
96		8	1.40	972	1360.80	
97		8	1.35	4	5.40	
98		8	1.20	422	506.40	
99		8	1.20	39	46.80	
100		8	1.20	52	62.40	
101		8	1.26	8	10.08	
102		8	1.05	1780	1869.00	
103		8	0.94	2	1.88	
104		8	0.90	2	1.80	

ISKAZ ARMATURE	
GRAĐEVINA:	REKONSTRUKCIJA TERMALNOG REKREACIJSKOG CENTRA TERME TUHELJ
ISKAZ UZ NACRT:	E-1_302-305_0
SADRŽAJ:	ARMATURA STROPNE PLOČE ETAŽA -1
DATUM:	srpanj, 2023.

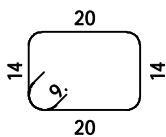
Šipke - specifikacija						
ozn	oblik i mjere [cm]	Ø	lg [m]	n [kom]	lgn [m]	Napomena
105		8	0.86	8	6.88	

ISKAZ ARMATURE	
GRAĐEVINA:	REKONSTRUKCIJA TERMALNOG REKREACIJSKOG CENTRA TERME TUHELJ
ISKAZ UZ NACRT:	E-1_302-305_0
SADRŽAJ:	ARMATURA STROPNE PLOČE ETAŽA -1
DATUM:	srpanj, 2023.

Šipke - rekapitulacija			
Ø [mm]	lgn [m]	Jedinična težina [kg/m ¹]	Težina [kg]
B500B			
8	12855.52	0.40	5077.93
10	3261.00	0.62	2012.04
12	1111.00	0.89	986.57
14	1312.48	1.21	1588.10
16	405.50	1.58	640.69
20	937.60	2.47	2315.87
Ukupno (B500B)			12621.20
Ukupno			12621.20

ISKAZ ARMATURE	
GRAĐEVINA:	REKONSTRUKCIJA TERMALNOG REKREACIJSKOG CENTRA TERME TUHELJ
ISKAZ UZ NACRT:	E-1_302-305_0
SADRŽAJ:	ARMATURA STROPNE PLOČE ETAŽA -1
DATUM:	srpanj, 2023.

Mreže - specifikacija							
Pozicija	Oznaka mreže	B [cm]	L [cm]	n	Jedinična težina [kg/m ²]	Ukupna težina [kg]	Napomena
STROPNA PLOČA ETAŽA -1 (1 kom)							
11	Q-335	215	600	72	5.38	4996.94	
11-1	Q-335	215	600	7	5.38	485.81	
11-2	Q-335	215	384	1	5.38	44.36	
11-3	Q-335	215	375	1	5.38	43.32	
11-4	Q-335	215	330	1	5.38	38.19	
11-5	Q-335	193	240	1	5.38	24.87	
11-6	Q-335	70	455	1	5.38	17.05	
11-7	Q-335	215	376	1	5.38	43.49	
11-8	Q-335	161	291	1	5.38	25.16	
11-9	Q-335	215	386	1	5.38	44.65	
11-10	Q-335	215	396	1	5.38	45.82	
11-11	Q-335	215	406	1	5.38	46.99	
11-12	Q-335	215	416	1	5.38	48.15	
11-13	Q-335	133	419	1	5.38	30.07	
11-14	Q-335	215	560	1	5.38	64.78	
11-15	Q-335	215	238	1	5.38	27.48	
11-16	Q-335	215	236	1	5.38	27.33	
11-17	Q-335	215	232	1	5.38	26.81	
11-18	Q-335	211	227	1	5.38	25.77	
11-19	Q-335	215	585	1	5.38	67.64	
11-20	Q-335	215	406	1	5.38	46.94	
11-21	Q-335	73	227	1	5.38	8.88	
11-22	Q-335	215	507	1	5.38	58.61	
11-23	Q-335	197	295	1	5.38	31.35	
11-24	Q-335	211	600	1	5.38	68.14	
11-25	Q-335	169	247	1	5.38	22.54	
11-26	Q-335	77	483	1	5.38	20.07	
11-27	Q-335	160	508	1	5.38	43.83	
11-28	Q-335	141	600	1	5.38	45.42	
11-29	Q-335	186	600	1	5.38	60.04	
11-30	Q-335	215	400	1	5.38	46.30	
11-31	Q-335	215	229	1	5.38	26.48	
11-32	Q-335	215	243	1	5.38	28.08	
11-33	Q-335	215	272	1	5.38	31.42	
11-34	Q-335	215	286	1	5.38	33.03	
11-35	Q-335	215	299	1	5.38	34.63	
11-36	Q-335	215	313	1	5.38	36.24	

ISKAZ ARMATURE	
GRAĐEVINA:	REKONSTRUKCIJA TERMALNOG REKREACIJSKOG CENTRA TERME TUHELJ
ISKAZ UZ NACRT:	E-1_302-305_0
SADRŽAJ:	ARMATURA STROPNE PLOČE ETAŽA -1
DATUM:	srpanj, 2023.

Mreže - specifikacija							
Pozicija	Oznaka mreže	B [cm]	L [cm]	n	Jedinična težina [kg/m ²]	Ukupna težina [kg]	Napomena
11-37	Q-335	215	320	1	5.38	36.99	
11-38	Q-335	176	258	1	5.38	24.39	
11-39	Q-335	215	435	1	5.38	50.31	
11-40	Q-335	200	235	1	5.38	25.36	
11-41	Q-335	183	487	1	5.38	47.95	
11-42	Q-335	215	564	1	5.38	65.18	
11-43	Q-335	215	561	1	5.38	64.93	
11-44	Q-335	215	557	1	5.38	64.40	
11-45	Q-335	215	552	1	5.38	63.86	
11-46	Q-335	215	547	1	5.38	63.33	
11-47	Q-335	215	495	1	5.38	57.31	
11-48	Q-335	215	420	1	5.38	48.63	
11-49	Q-335	187	243	1	5.38	24.49	
11-50	Q-335	215	600	10	5.38	694.02	
11-51	Q-335	215	313	1	5.38	36.25	
11-52	Q-335	215	326	1	5.38	37.69	
11-53	Q-335	215	332	1	5.38	38.41	
11-54	Q-335	215	338	1	5.38	39.06	
11-55	Q-335	122	600	1	5.38	39.45	
11-56	Q-335	97	330	1	5.38	17.21	
11-57	Q-335	215	359	1	5.38	41.52	
11-58	Q-335	215	345	1	5.38	39.96	
11-59	Q-335	215	308	1	5.38	35.61	
11-60	Q-335	215	270	1	5.38	31.25	
11-61	Q-335	114	600	1	5.38	36.67	
11-62	Q-335	118	123	1	5.38	7.76	
11-63	Q-335	215	229	1	5.38	26.45	
11-64	Q-335	215	194	1	5.38	22.42	
11-65	Q-335	215	136	1	5.38	15.68	
11-66	Q-335	64	77	1	5.38	2.64	
11-67	Q-335	208	600	1	5.38	67.04	
11-68	Q-335	215	600	8	5.38	555.22	
11-69	Q-335	190	287	1	5.38	29.37	
11-70	Q-335	215	240	1	5.38	27.81	
11-71	Q-335	171	121	1	5.38	11.11	
11-72	Q-335	215	546	1	5.38	63.16	
11-73	Q-335	215	436	1	5.38	50.43	
11-74	Q-335	215	316	1	5.38	36.57	

ISKAZ ARMATURE	
GRAĐEVINA:	REKONSTRUKCIJA TERMALNOG REKREACIJSKOG CENTRA TERME TUHELJ
ISKAZ UZ NACRT:	E-1_302-305_0
SADRŽAJ:	ARMATURA STROPNE PLOČE ETAŽA -1
DATUM:	srpanj, 2023.

Mreže - specifikacija							
Pozicija	Oznaka mreže	B [cm]	L [cm]	n	Jedinična težina [kg/m ²]	Ukupna težina [kg]	Napomena
11-75	Q-335	215	196	1	5.38	22.71	
11-76	Q-335	215	77	1	5.38	8.85	
11-77	Q-335	80	426	1	5.38	18.35	
11-78	Q-335	215	514	1	5.38	59.46	
11-79	Q-335	215	514	1	5.38	59.46	
11-80	Q-335	215	514	1	5.38	59.46	
11-81	Q-335	215	514	1	5.38	59.46	
11-82	Q-335	215	449	1	5.38	51.88	
11-83	Q-335	215	449	1	5.38	51.88	
11-84	Q-335	215	449	1	5.38	51.88	
11-85	Q-335	215	449	1	5.38	51.88	
11-86	Q-335	151	449	1	5.38	36.49	
11-87	Q-335	215	132	4	5.38	61.07	
11-88	Q-335	215	600	14	5.38	971.63	
11-89	Q-335	215	331	1	5.38	38.29	
11-90	Q-335	215	247	1	5.38	28.53	
11-91	Q-335	158	600	1	5.38	50.96	
11-92	Q-335	158	220	1	5.38	18.68	
11-93	Q-335	93	600	1	5.38	30.02	
11-94	Q-335	215	272	2	5.38	62.95	
11-95	Q-335	174	272	1	5.38	25.47	
11-96	Q-335	215	230	1	5.38	26.60	
11-97	Q-335	168	230	1	5.38	20.74	
11-98	Q-335	215	279	1	5.38	32.29	
11-99	Q-335	215	600	17	5.38	1179.83	
11-100	Q-335	159	600	1	5.38	51.20	
11-101	Q-335	102	239	1	5.38	13.12	
11-102	Q-335	215	239	1	5.38	27.61	
11-103	Q-335	215	239	1	5.38	27.62	
11-104	Q-335	215	239	1	5.38	27.63	
11-105	Q-335	215	239	1	5.38	27.65	
11-106	Q-335	215	239	1	5.38	27.66	
11-107	Q-335	215	239	1	5.38	27.67	
11-108	Q-335	215	239	1	5.38	27.68	
11-109	Q-335	215	239	1	5.38	27.70	
11-110	Q-335	215	240	1	5.38	27.71	
11-111	Q-335	215	240	1	5.38	27.72	
11-112	Q-335	215	240	1	5.38	27.73	

ISKAZ ARMATURE	
GRAĐEVINA:	REKONSTRUKCIJA TERMALNOG REKREACIJSKOG CENTRA TERME TUHELJ
ISKAZ UZ NACRT:	E-1_302-305_0
SADRŽAJ:	ARMATURA STROPNE PLOČE ETAŽA -1
DATUM:	srpanj, 2023.

Mreže - specifikacija							
Pozicija	Oznaka mreže	B [cm]	L [cm]	n	Jedinična težina [kg/m ²]	Ukupna težina [kg]	Napomena
11-113	Q-335	215	240	1	5.38	27.75	
11-114	Q-335	215	241	1	5.38	27.93	
11-115	Q-335	215	253	1	5.38	29.23	
11-116	Q-335	215	264	1	5.38	30.53	
11-117	Q-335	215	275	1	5.38	31.83	
11-118	Q-335	215	286	1	5.38	33.13	
11-119	Q-335	215	298	1	5.38	34.43	
11-120	Q-335	215	324	1	5.38	37.43	
11-121	Q-335	215	335	1	5.38	38.73	
11-122	Q-335	215	266	1	5.38	30.75	
11-123	Q-335	215	173	1	5.38	20.05	
11-124	Q-335	215	437	1	5.38	50.53	
11-125	Q-335	215	344	1	5.38	39.82	
11-126	Q-335	215	252	1	5.38	29.12	
11-127	Q-335	215	516	1	5.38	59.65	
11-128	Q-335	121	212	1	5.38	13.83	
11-129	Q-335	215	562	1	5.38	65.02	
11-130	Q-335	215	108	1	5.38	12.48	
11-131	Q-335	215	122	1	5.38	14.07	
11-132	Q-335	215	135	1	5.38	15.67	
11-133	Q-335	215	76	1	5.38	8.81	
11-134	Q-335	215	111	1	5.38	12.80	
11-135	Q-335	215	570	1	5.38	65.93	
11-136	Q-335	215	85	1	5.38	9.84	
11-137	Q-335	215	114	1	5.38	13.14	
11-138	Q-335	215	576	1	5.38	66.63	
11-139	Q-335	215	94	1	5.38	10.88	
11-140	Q-335	215	112	1	5.38	13.00	
11-141	Q-335	215	582	3	5.38	201.96	
11-142	Q-335	215	94	1	5.38	10.91	
11-143	Q-335	215	112	1	5.38	12.99	
11-144	Q-335	215	94	1	5.38	10.91	
11-145	Q-335	215	112	1	5.38	12.99	
11-146	Q-335	215	94	1	5.38	10.91	
11-147	Q-335	215	112	1	5.38	12.99	
11-148	Q-335	215	256	1	5.38	29.60	
11-149	Q-335	215	268	1	5.38	30.97	
11-150	Q-335	215	294	1	5.38	34.02	

ISKAZ ARMATURE	
GRAĐEVINA:	REKONSTRUKCIJA TERMALNOG REKREACIJSKOG CENTRA TERME TUHELJ
ISKAZ UZ NACRT:	E-1_302-305_0
SADRŽAJ:	ARMATURA STROPNE PLOČE ETAŽA -1
DATUM:	srpanj, 2023.

Mreže - specifikacija							
Pozicija	Oznaka mreže	B [cm]	L [cm]	n	Jedinična težina [kg/m ²]	Ukupna težina [kg]	Napomena
11-151	Q-335	215	305	1	5.38	35.27	
11-152	Q-335	215	316	1	5.38	36.52	
11-153	Q-335	215	327	1	5.38	37.77	
11-154	Q-335	167	329	1	5.38	29.45	
11-155	Q-335	215	349	1	5.38	40.38	
11-156	Q-335	215	358	1	5.38	41.46	
11-157	Q-335	215	351	1	5.38	40.58	
11-158	Q-335	215	338	1	5.38	39.04	
11-159	Q-335	215	318	1	5.38	36.75	
11-160	Q-335	215	298	1	5.38	34.46	
11-161	Q-335	81	278	1	5.38	12.07	
11-162	Q-335	215	363	1	5.38	41.96	
11-163	Q-335	215	424	1	5.38	49.00	
11-164	Q-335	215	420	1	5.38	48.63	
11-165	Q-335	215	426	1	5.38	49.23	
11-166	Q-335	215	432	1	5.38	49.95	
11-167	Q-335	130	311	1	5.38	21.75	
11-168	Q-335	215	281	1	5.38	32.49	
11-169	Q-335	215	327	1	5.38	37.82	
11-170	Q-335	215	373	1	5.38	43.16	
11-171	Q-335	209	404	1	5.38	45.51	
11-172	Q-335	215	338	1	5.38	39.11	
11-173	Q-335	215	266	1	5.38	30.78	
11-174	Q-335	80	540	1	5.38	23.20	
Ukupno						15011.73	

ISKAZ ARMATURE	
GRAĐEVINA:	REKONSTRUKCIJA TERMALNOG REKREACIJSKOG CENTRA TERME TUHELJ
ISKAZ UZ NACRT:	E-1_302-305_0
SADRŽAJ:	ARMATURA STROPNE PLOČE ETAŽA -1
DATUM:	srpanj, 2023.

Mreže - rekapitulacija						
Oznaka mreže	B [cm]	L [cm]	n	Jedinična težina [kg/m ²]	Ukupna težina [kg]	Neto ugrađena težina [kg]
Q-335	215	600	226	5.38	15684.85	14169.72
Ukupno					15684.85	14169.72

ISKAZ ARMATURE	
GRAĐEVINA:	REKONSTRUKCIJA TERMALNOG REKREACIJSKOG CENTRA TERME TUHELJ
ISKAZ UZ NACRT:	E-1_302-305_0
SADRŽAJ:	ARMATURA STROPNE PLOČE ETAŽA -1
DATUM:	srpanj, 2023.

Mreže - plan rezanja
STROPNA PLOČA ETAŽA -1
Q-335 (600 cm x 215 cm)

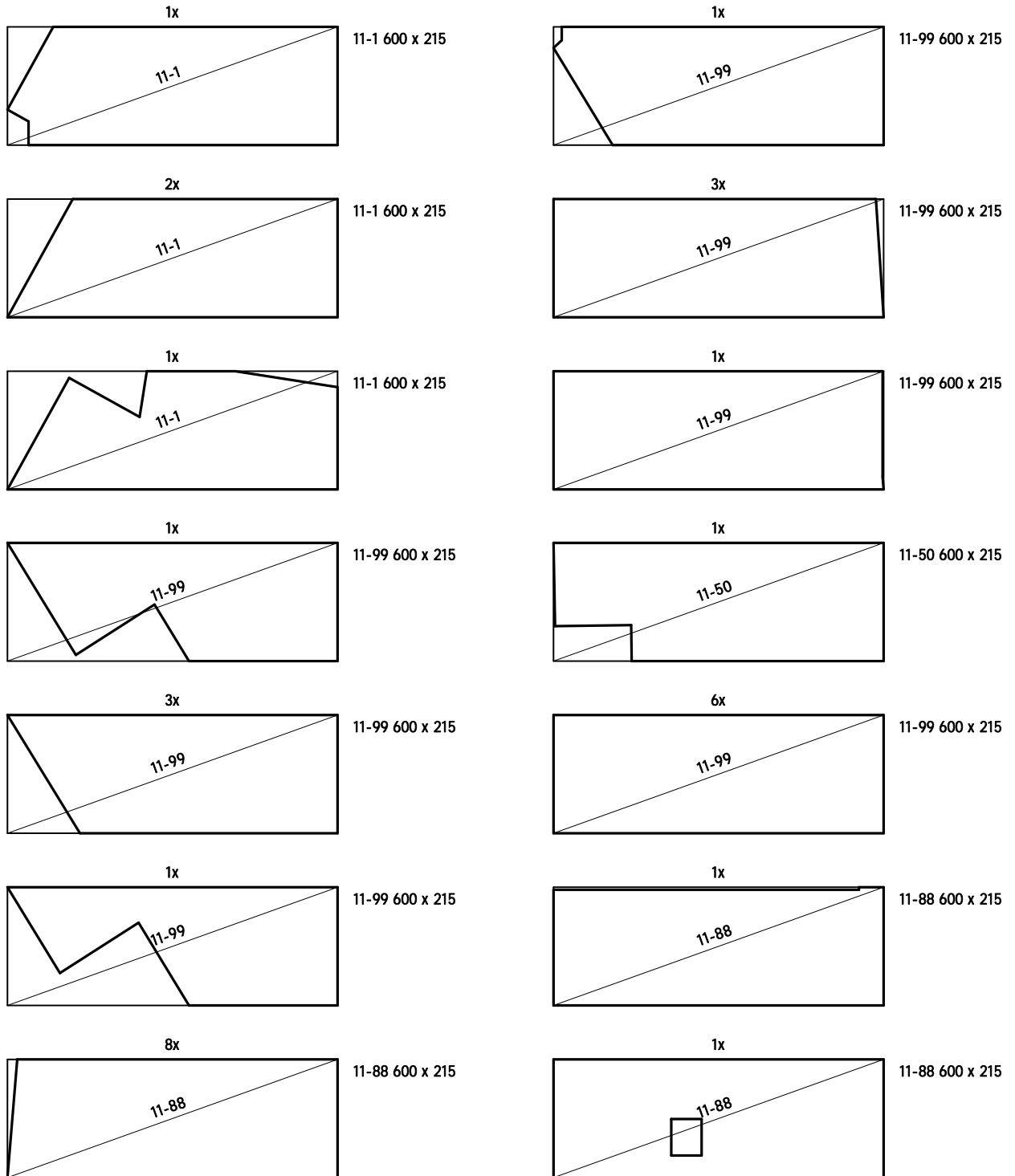

ISKAZ ARMATURE

GRAĐEVINA:	REKONSTRUKCIJA TERMALNOG REKREACIJSKOG CENTRA TERME TUHELJ
ISKAZ UZ NACRT:	E-1_302-305_0
SADRŽAJ:	ARMATURA STROPNE PLOČE ETAŽA -1
DATUM:	srpanj, 2023.

Mreže - plan rezanja

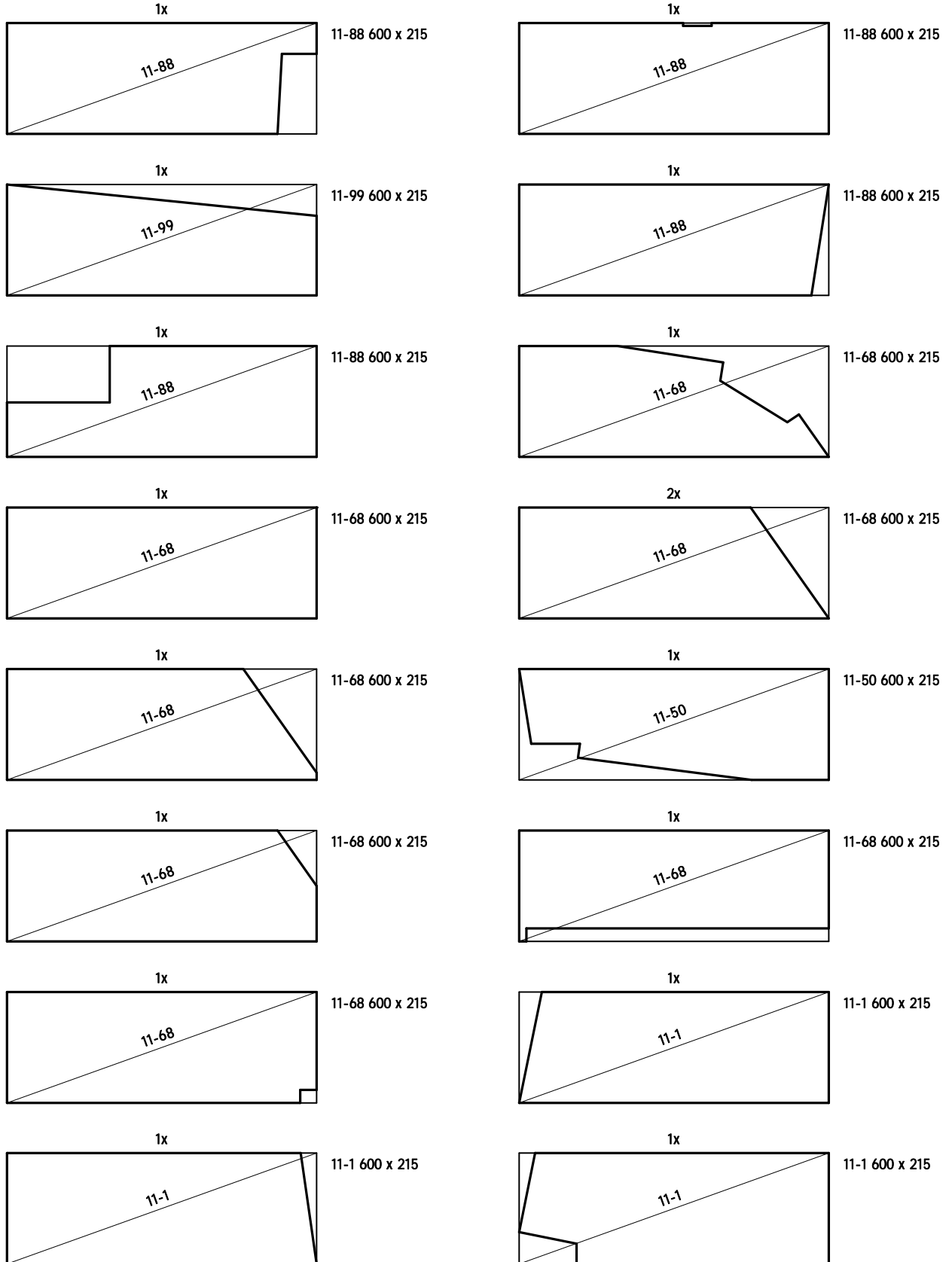

ISKAZ ARMATURE

GRAĐEVINA:	REKONSTRUKCIJA TERMALNOG REKREACIJSKOG CENTRA TERME TUHELJ
ISKAZ UZ NACRT:	E-1_302-305_0
SADRŽAJ:	ARMATURA STROPNE PLOČE ETAŽA -1
DATUM:	srpanj, 2023.

Mreže - plan rezanja

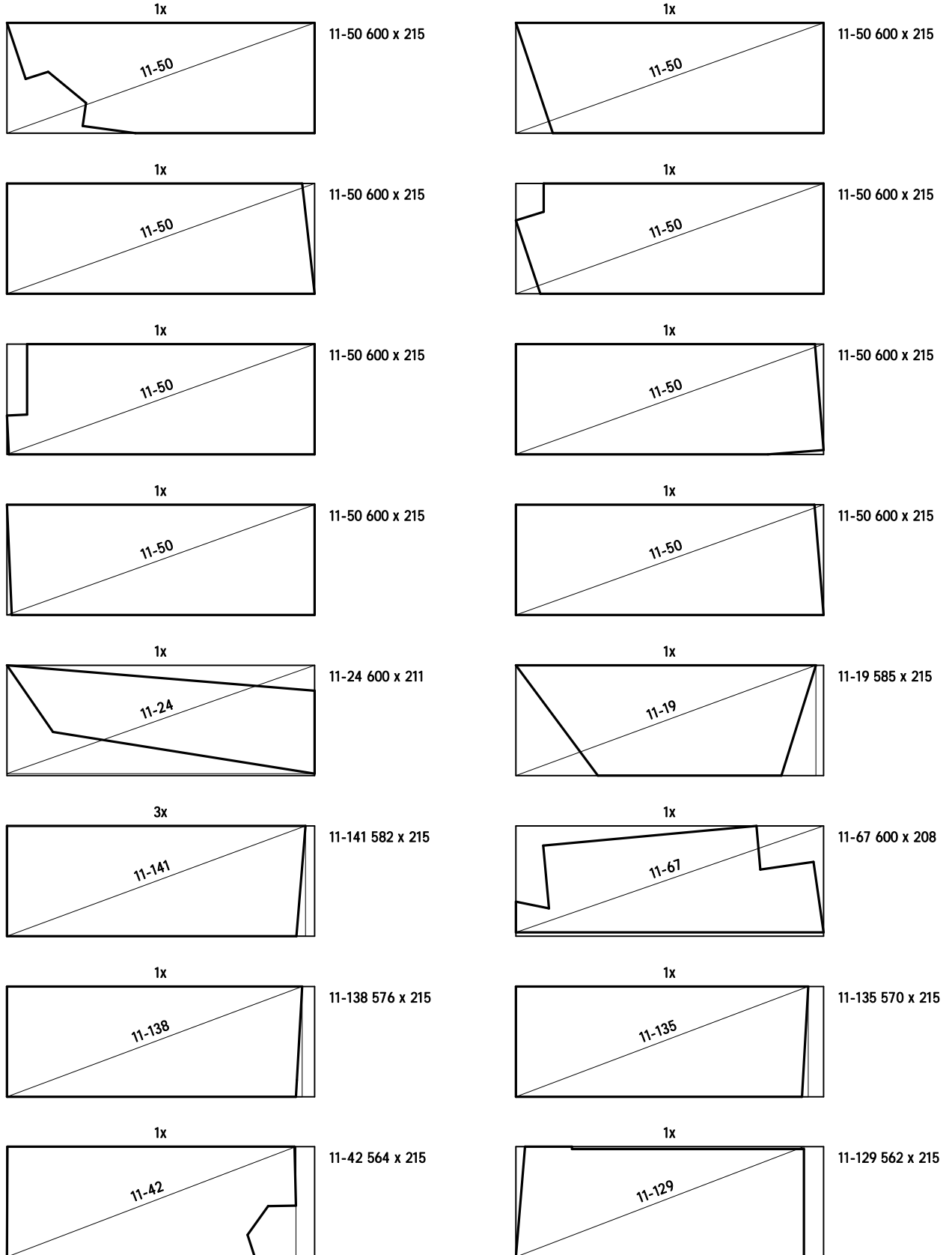

ISKAZ ARMATURE

GRAĐEVINA:	REKONSTRUKCIJA TERMALNOG REKREACIJSKOG CENTRA TERME TUHELJ
ISKAZ UZ NACRT:	E-1_302-305_0
SADRŽAJ:	ARMATURA STROPNE PLOČE ETAŽA -1
DATUM:	srpanj, 2023.

Mreže - plan rezanja

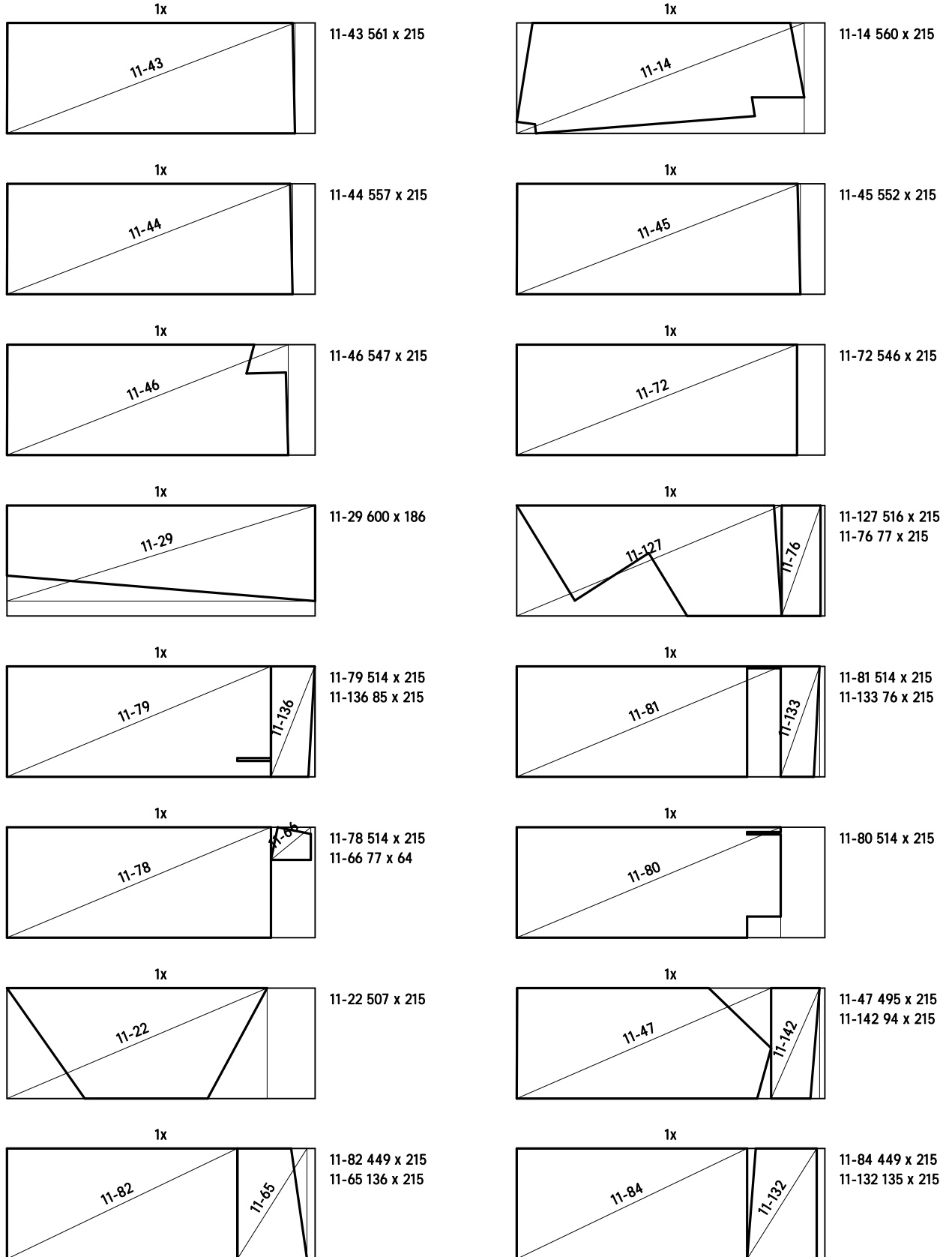

ISKAZ ARMATURE

GRAĐEVINA:	REKONSTRUKCIJA TERMALNOG REKREACIJSKOG CENTRA TERME TUHELJ
ISKAZ UZ NACRT:	E-1_302-305_0
SADRŽAJ:	ARMATURA STROPNE PLOČE ETAŽA -1
DATUM:	srpanj, 2023.

Mreže - plan rezanja

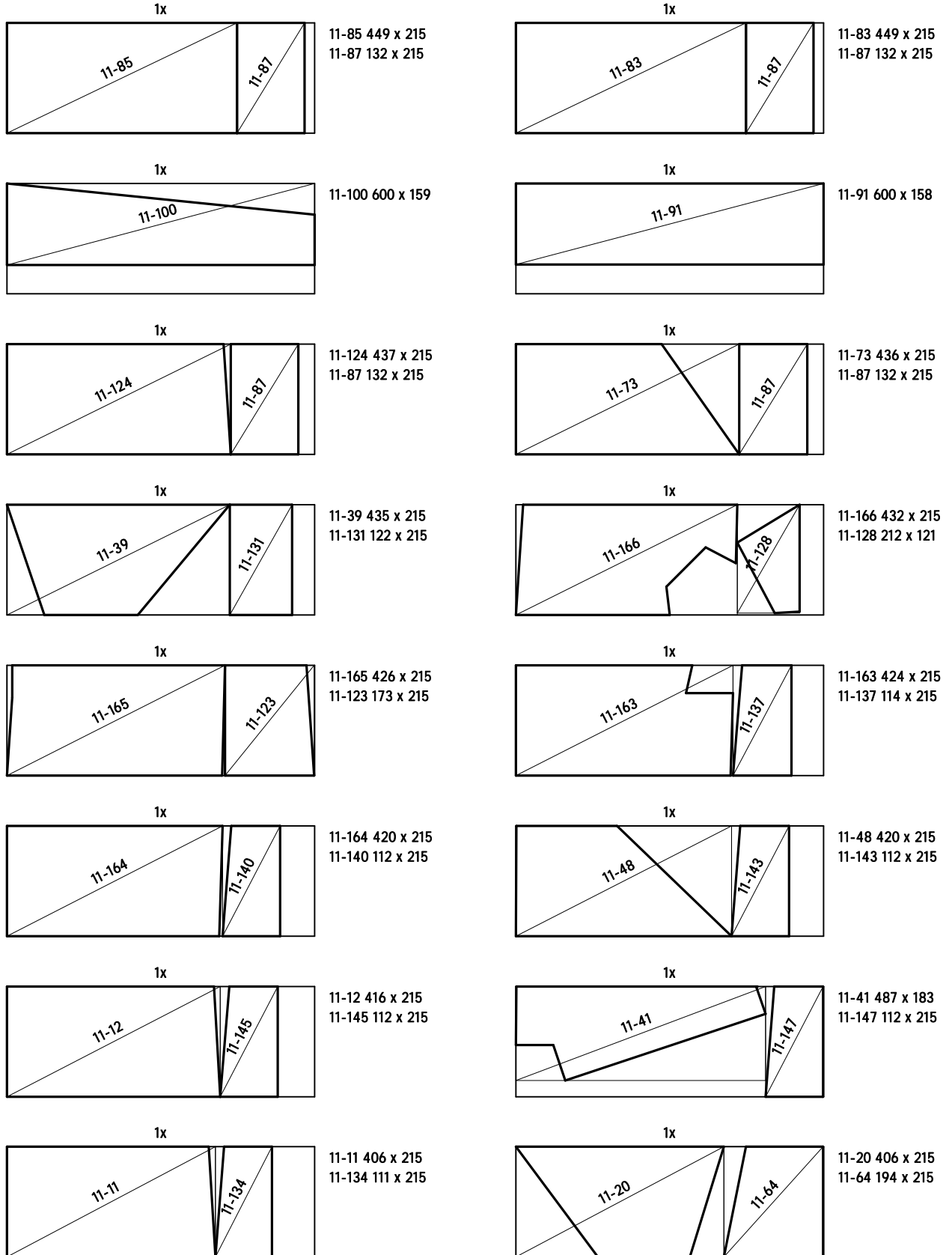

ISKAZ ARMATURE

GRAĐEVINA:	REKONSTRUKCIJA TERMALNOG REKREACIJSKOG CENTRA TERME TUHELJ
ISKAZ UZ NACRT:	E-1_302-305_0
SADRŽAJ:	ARMATURA STROPNE PLOČE ETAŽA -1
DATUM:	srpanj, 2023.

Mreže - plan rezanja

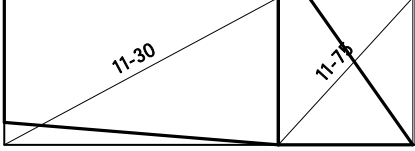
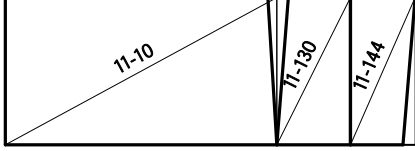
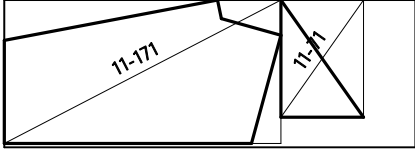
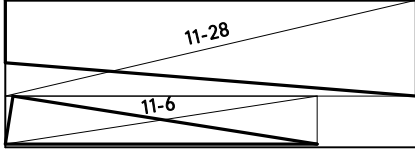
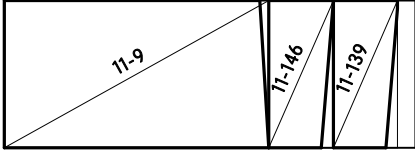
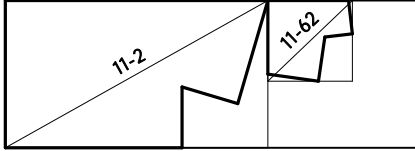
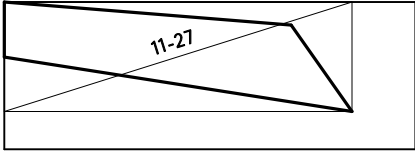
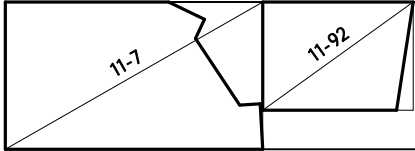
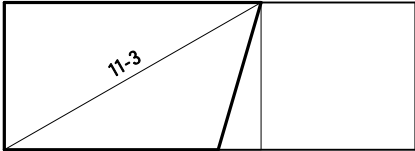
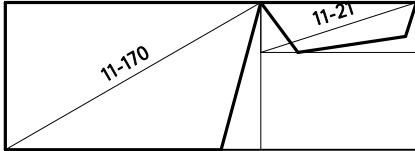
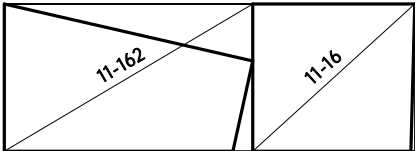
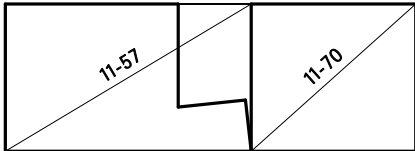
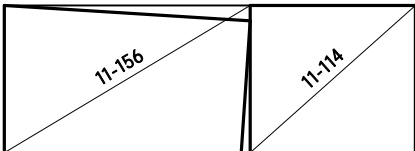
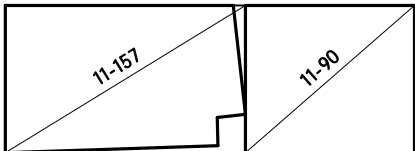
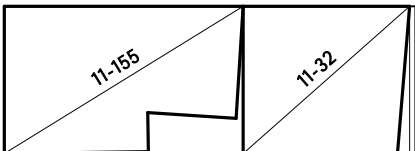
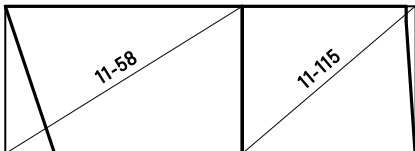
1x 	11-30 400 x 215 11-75 196 x 215	1x 	11-10 396 x 215 11-130 108 x 215 11-144 94 x 215
1x 	11-171 404 x 209 11-71 121 x 171	1x 	11-28 600 x 141 11-6 455 x 70
1x 	11-9 386 x 215 11-146 94 x 215 11-139 94 x 215	1x 	11-2 384 x 215 11-62 123 x 118
1x 	11-27 508 x 160	1x 	11-7 376 x 215 11-92 220 x 158
1x 	11-3 375 x 215	1x 	11-170 373 x 215 11-21 227 x 73
1x 	11-162 363 x 215 11-16 236 x 215	1x 	11-57 359 x 215 11-70 240 x 215
1x 	11-156 358 x 215 11-114 241 x 215	1x 	11-157 351 x 215 11-90 247 x 215
1x 	11-155 349 x 215 11-32 243 x 215	1x 	11-58 345 x 215 11-115 253 x 215

ISKAZ ARMATURE

GRAĐEVINA:	REKONSTRUKCIJA TERMALNOG REKREACIJSKOG CENTRA TERME TUHELJ
ISKAZ UZ NACRT:	E-1_302-305_0
SADRŽAJ:	ARMATURA STROPNE PLOČE ETAŽA -1
DATUM:	srpanj, 2023.

Mreže - plan rezanja

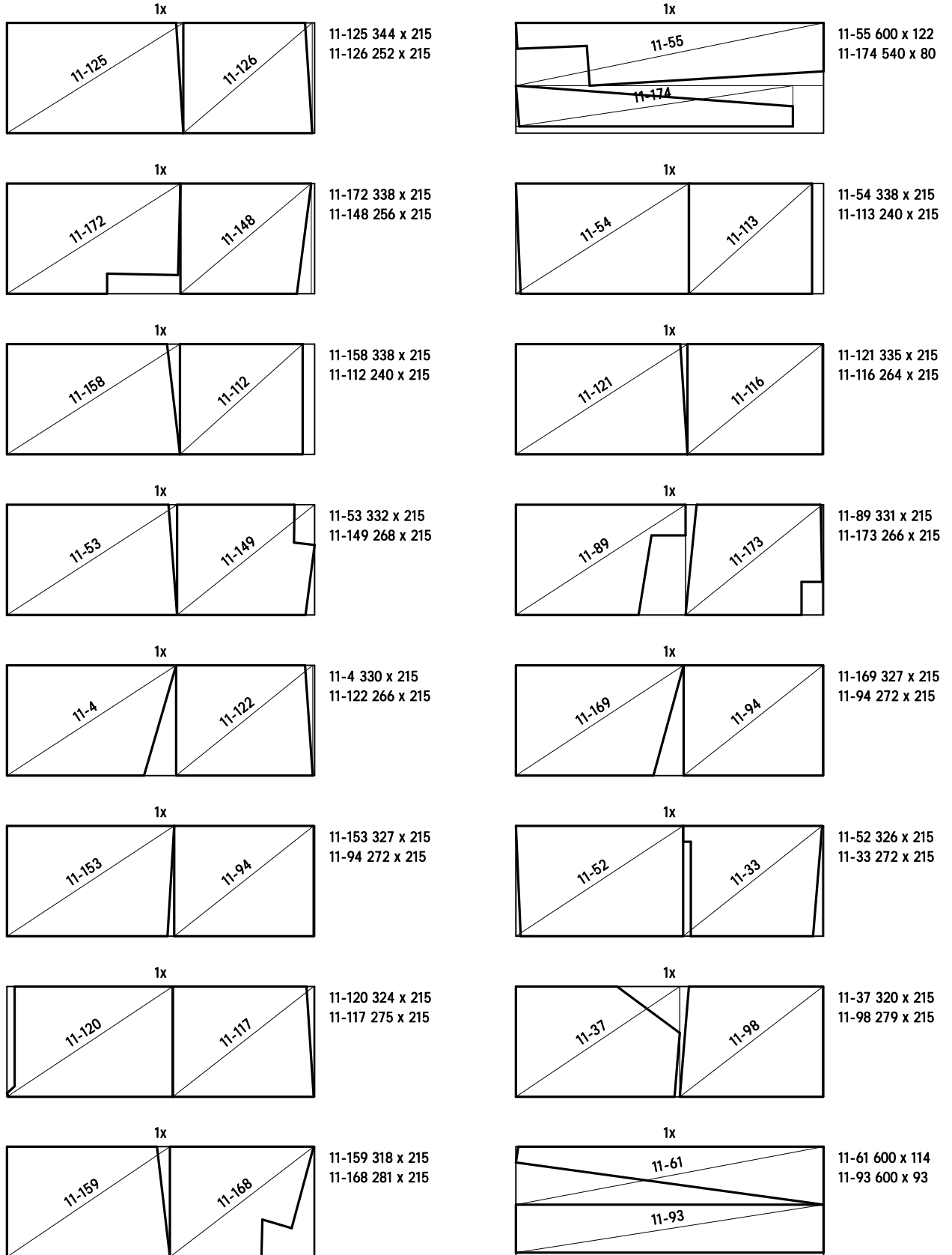

ISKAZ ARMATURE

GRAĐEVINA:	REKONSTRUKCIJA TERMALNOG REKREACIJSKOG CENTRA TERME TUHELJ
ISKAZ UZ NACRT:	E-1_302-305_0
SADRŽAJ:	ARMATURA STROPNE PLOČE ETAŽA -1
DATUM:	srpanj, 2023.

Mreže - plan rezanja

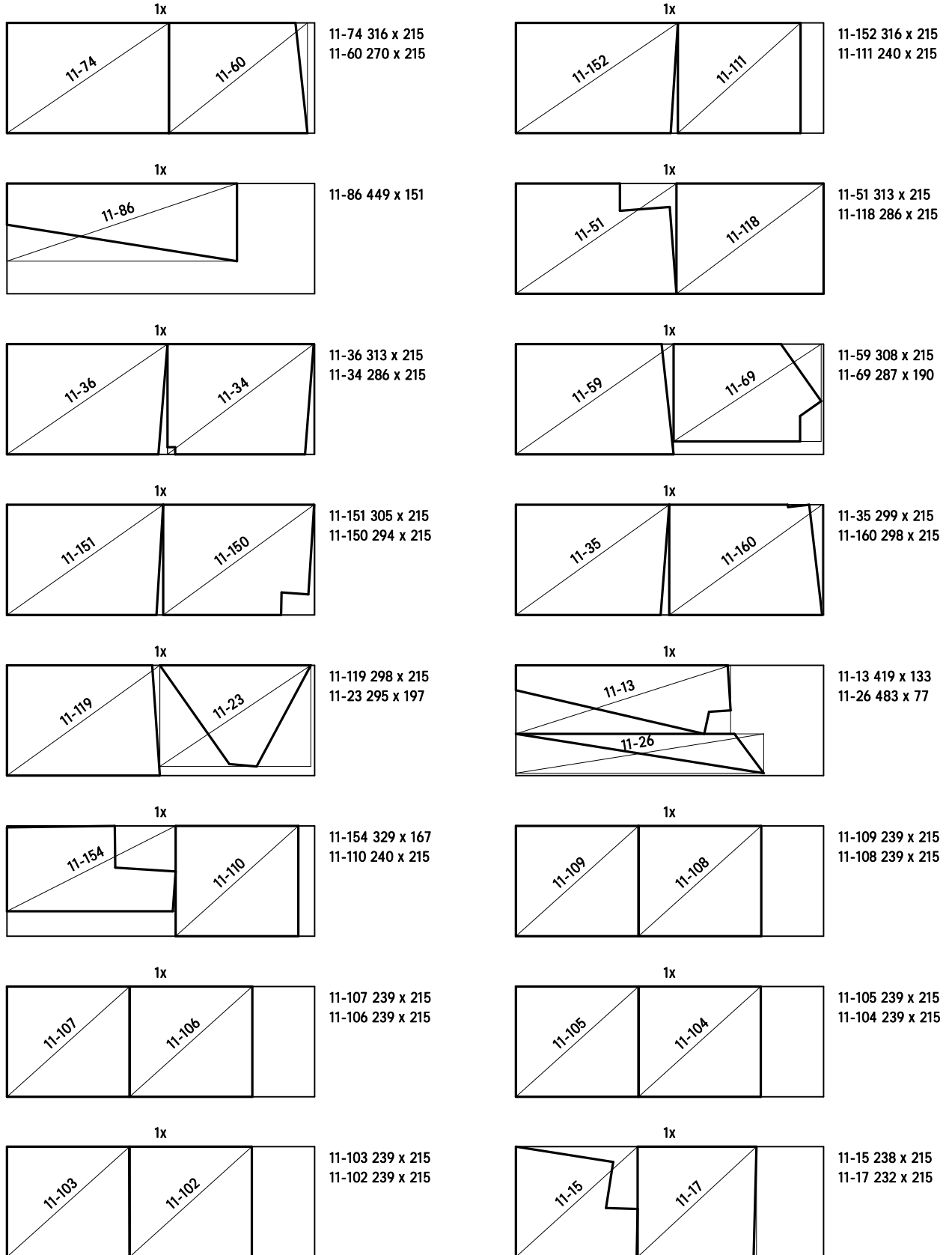

ISKAZ ARMATURE	
GRAĐEVINA:	REKONSTRUKCIJA TERMALNOG REKREACIJSKOG CENTRA TERME TUHELJ
ISKAZ UZ NACRT:	E-1_302-305_0
SADRŽAJ:	ARMATURA STROPNE PLOČE ETAŽA -1
DATUM:	srpanj, 2023.

Mreže - plan rezanja

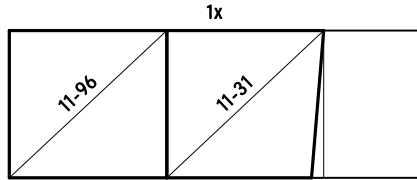

11-96 230 x 215
11-31 229 x 215

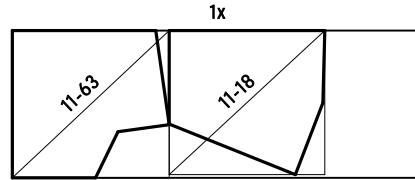

11-63 229 x 215
11-18 227 x 211

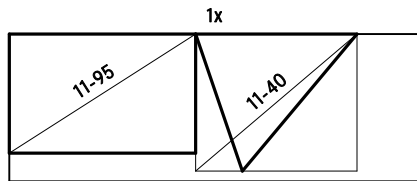

11-95 272 x 174
11-40 235 x 200

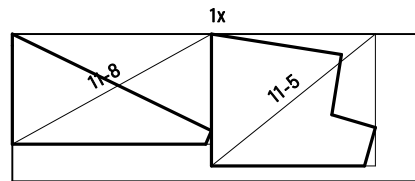

11-8 291 x 161
11-5 240 x 193

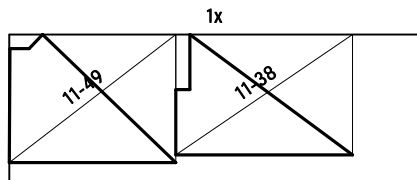

11-49 243 x 187
11-38 258 x 176

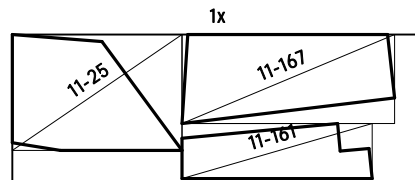

11-25 247 x 169
11-167 311 x 130
11-161 278 x 81

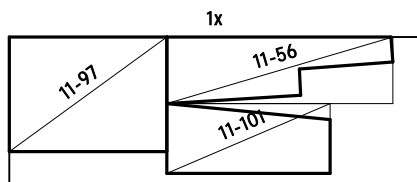

11-97 230 x 168
11-56 330 x 97
11-101 239 x 102

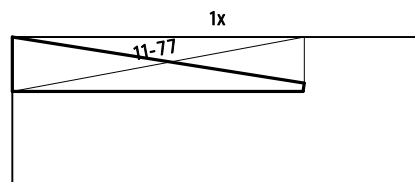

11-77 426 x 80

ISKAZ ARMATURE	
GRAĐEVINA:	REKONSTRUKCIJA TERMALNOG REKREACIJSKOG CENTRA TERME TUHELJ
ISKAZ UZ NACRT:	E-1_306_0
SADRŽAJ:	ARMATURA STROPNE PLOČE ETAŽA -1 - KAPITELI
DATUM:	srpanj, 2023.

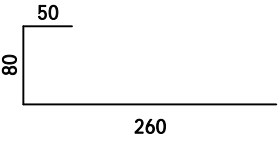
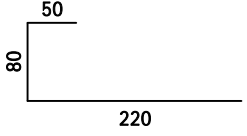
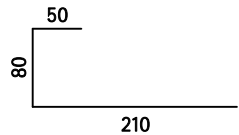
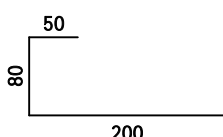
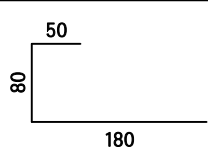
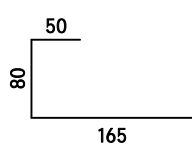
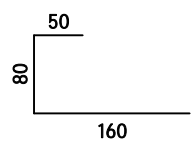
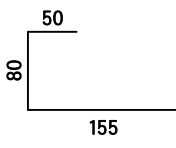
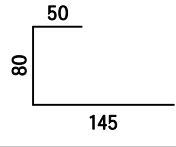
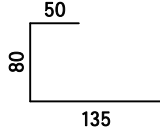
Šipke - specifikacija						
ozn	oblik i mjere [cm]	Ø	lg [m]	n [kom]	lgn [m]	Napomena
KAPITELI STROPNA PLOČA ETAŽA -1 (1 kom)						
1		16	3.90	26	101.40	
2		16	3.50	82	287.00	
3		16	3.40	44	149.60	
4		16	3.30	56	184.80	
5		16	3.10	114	353.40	
6		16	2.95	54	159.30	
7		16	2.90	36	104.40	
8		16	2.85	30	85.50	
9		16	2.75	60	165.00	
10		16	2.65	56	148.40	

ISKAZ ARMATURE

GRAĐEVINA:	REKONSTRUKCIJA TERMALNOG REKREACIJSKOG CENTRA TERME TUHELJ
ISKAZ UZ NACRT:	E-1_306_0
SADRŽAJ:	ARMATURA STROPNE PLOČE ETAŽA -1 - KAPITELI
DATUM:	srpanj, 2023.

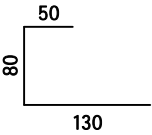
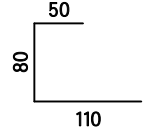
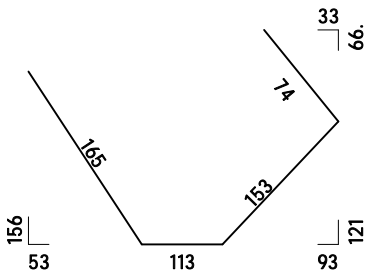
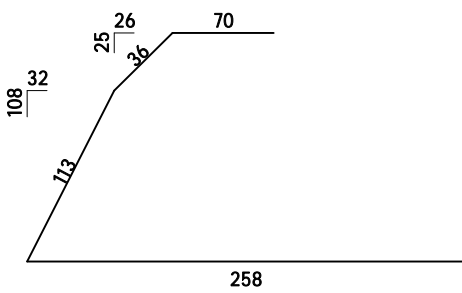
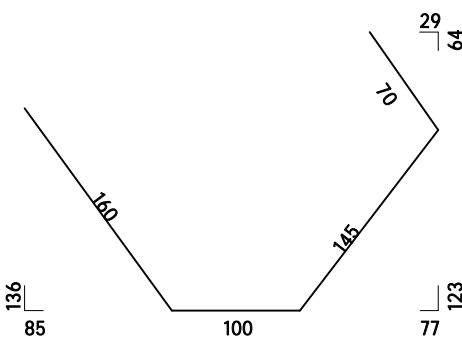
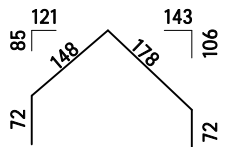
Šipke - specifikacija						
ozn	oblik i mjere [cm]	Ø	lg [m]	n [kom]	lgn [m]	Napomena
11		16	2.60	28	72.80	
12		16	2.40	28	67.20	
13		12	5.05	3	15.15	
14		12	4.77	3	14.31	
15		12	4.75	3	14.25	
16		12	4.70	3	14.10	

ISKAZ ARMATURE	
GRAĐEVINA:	REKONSTRUKCIJA TERMALNOG REKREACIJSKOG CENTRA TERME TUHELJ
ISKAZ UZ NACRT:	E-1_306_0
SADRŽAJ:	ARMATURA STROPNE PLOČE ETAŽA -1 - KAPITELI
DATUM:	srpanj, 2023.

Šipke - specifikacija						
ozn	oblik i mjere [cm]	Ø	lg [m]	n [kom]	lgn [m]	Napomena
17		12	4.65	3	13.95	
18		12	4.60	3	13.80	
19		12	4.55	3	13.65	
20		12	4.50	3	13.50	
21		12	4.45	3	13.35	

ISKAZ ARMATURE	
GRAĐEVINA:	REKONSTRUKCIJA TERMALNOG REKREACIJSKOG CENTRA TERME TUHELJ
ISKAZ UZ NACRT:	E-1_306_0
SADRŽAJ:	ARMATURA STROPNE PLOČE ETAŽA -1 - KAPITELI
DATUM:	srpanj, 2023.

Šipke - specifikacija						
ozn	oblik i mjere [cm]	Ø	lg [m]	n [kom]	lgn [m]	Napomena
22		12	4.40	3	13.20	
23		12	4.35	6	26.10	
24		12	4.35	3	13.05	
25		12	4.35	3	13.05	
26		12	4.20	3	12.60	
27		12	4.15	3	12.45	

ISKAZ ARMATURE	
GRAĐEVINA:	REKONSTRUKCIJA TERMALNOG REKREACIJSKOG CENTRA TERME TUHELJ
ISKAZ UZ NACRT:	E-1_306_0
SADRŽAJ:	ARMATURA STROPNE PLOČE ETAŽA -1 - KAPITELI
DATUM:	srpanj, 2023.

Šipke - specifikacija						
ozn	oblik i mjere [cm]	Ø	lg [m]	n [kom]	lg _n [m]	Napomena
28		12	4.10	6	24.60	
29		12	4.05	3	12.15	
30		12	4.00	3	12.00	
31		12	3.70	3	11.10	
32		12	3.63	3	10.89	
33		12	3.60	3	10.80	
34		12	3.22	3	9.66	

ISKAZ ARMATURE	
GRAĐEVINA:	REKONSTRUKCIJA TERMALNOG REKREACIJSKOG CENTRA TERME TUHELJ
ISKAZ UZ NACRT:	E-1_306_0
SADRŽAJ:	ARMATURA STROPNE PLOČE ETAŽA -1 - KAPITELI
DATUM:	srpanj, 2023.

Šipke - rekapitulacija			
Ø [mm]	lgn [m]	Jedinična težina [kg/m']	Težina [kg]
B500B			
8	0.00	0.40	0.00
10	0.00	0.62	0.00
12	307.71	0.89	273.25
14	0.00	1.21	0.00
16	1878.80	1.58	2968.50
20	0.00	2.47	0.00
Ukupno (B500B)			3241.75
Ukupno			3241.75