

INVESTITOR: **TERME TUHELJ d.o.o.,**
Ljudevita Gaja 4,
49215 Tuheljske Toplice
OIB: 56566580479,

GRAĐEVINA: **REKONSTRUKCIJA TERMALNOG**
REKREACIJSKOG CENTRA
TERME TUHELJ

LOKACIJA: **k.č.br. 3199/1 k.o. Črešnjevec**

ZOP: **98-3/23**

BR. PROJEKTA: **TD 1906-06-IP**

MAPA: **MAPA III**

DIO: **DIO 3 – SMJEŠTAJNI PAVILJON**

FAZA: **IZVEDBENI PROJEKT**

VRSTA: **GRAĐEVINSKI PROJEKT**

GRAĐEVINSKI PROJEKT KONSTRUKCIJE BETONSKA KONSTRUKCIJA PLANOVI SAVIJANJA ARMATURE

GLAVNI PROJEKTANT: **Tomislav Vreš, dipl.ing.arh.**
br. ovlaštenja: A3627

PROJEKTANT KONSTRUKCIJE: **Antonio Maglov, dipl. ing. građ.**
br. ovlaštenja: G3775

SURADNICI: **Ana Majstorović, univ.mag.ing.aedif.**
Dorijan Sabljak, univ.mag.ing.aedif.
Lea Vlašić, univ.mag.ing.aedif.

DIREKTOR: **Antonio Maglov, dipl. ing. građ.**

SADRŽAJ

1. OPĆI PRILOZI

- Popis mapa glavnog projekta
- Izvadak iz registracije poduzeća
- Rješenje o upisu u Imenik ovlaštenih inženjera

2. ARMATURNI NACRTI

SMJEŠTAJNI PAVILJON

- ARM – TK – 601 – ARMATURA TEMELJNE KONSTRUKCIJE, ARMATURA DONJE ZONE
- ARM – TK – 602 – ARMATURA TEMELJNE KONSTRUKCIJE, ARMATURA GORNJE ZONE
- ARM – TK – 603 – ARMATURA TEMELJNE KONSTRUKCIJE, RUBNA ARMATURA I ANKERI
- ARM_TK_601-603_0 – ISKAZ
- ARM – E-1 – 601 – ARMATURA STROPNE PLOČE SUTERENA, STUBIŠTE
- ARM – E-1 – 601 – ISKAZ
- ARM – E-1 – 602 – ARMATURA STROPNE PLOČE SUTERENA, DONJA ZONA
- ARM – E-1 – 603 – ARMATURA STROPNE PLOČE SUTERENA, GORNJA ZONA
- ARM – E-1 – 604 – ARMATURA STROPNE PLOČE SUTERENA, RUBNA ARMATURA I ANKERI
- ARM – E-1 – 602-604 - ISKAZ
- ARM – E-1 – 605 – ARMATURA ZIDOVA 1/7
- ARM – E-1 – 606 – ARMATURA ZIDOVA 2/7
- ARM – E-1 – 607 – ARMATURA ZIDOVA 3/7
- ARM – E-1 – 608 – ARMATURA ZIDOVA 4/7
- ARM – E-1 – 609 – ARMATURA ZIDOVA 5/7
- ARM – E-1 – 610 – ARMATURA ZIDOVA 6/7
- ARM – E-1 – 611 – ARMATURA ZIDOVA 7/7
- ARM – E-1 – 605-611 - ISKAZ
- ARM – E0 – 601 – ARMATURA STROPNE PLOČE PRIZEMLJA, DONJA ZONA
- ARM – E0 – 602 – ARMATURA STROPNE PLOČE PRIZEMLJA, GORNJA ZONA
- ARM – E0 – 603 – ARMATURA STROPNE PLOČE PRIZEMLJA, RUBNA ARMATURA I ANKERI
- ARM_E0_601-603_0 – ISKAZ
- ARM – E1 – 601 – ARMATURA STROPNE PLOČE PRVOG KATA, DONJA ZONA
- ARM – E1 – 602 – ARMATURA STROPNE PLOČE PRVOG KATA, GORNJA ZONA
- ARM – E1 – 603 – ARMATURA STROPNE PLOČE PRVOG KATA, RUBNA ARMATURA I ANKERI
- ARM_E1_601-603_0 – ISKAZ
- ARM – E2 – 601 – ARMATURA STROPNE PLOČE DRUGOG KATA, DONJA ZONA
- ARM – E2 – 602 – ARMATURA STROPNE PLOČE DRUGOG KATA, GORNJA ZONA
- ARM – E2 – 603 – ARMATURA STROPNE PLOČE DRUGOG KATA, RUBNA ARMATURA I ANKERI
- ARM_E2_601-603_0 – ISKAZ
- ARM – E3 – 601 – ARMATURA KROVNE PLOČE, DONJA ZONA
- ARM – E3 – 602 – ARMATURA KROVNE PLOČE, GORNJA ZONA
- ARM – E3 – 603 – ARMATURA KROVNE PLOČE, RUBNA ARMATURA I ANKERI
- ARM_E3_601-603_0 – ISKAZ

1. OPĆI PRILOZI

Popis mapa izvedbenog projekta

PREGLED SVIH MAPA

MAPA I	ARHITEKTONSKI PROJEKT
Projektant	MIKELIĆ VREŠ ARHITEKTI d.o.o. Tomislav Vreš, dipl. ing. arh.
Broj projekta	98-3-IZ/23
MAPA II	PROJEKT KRAJOBRAZNOG UREĐENJA
Projektant	STUDIO SOL LANDSCAPE & ARCHITECTURE j.d.o.o. Stanislava Odrlijin, mag. ing. arch.
Broj projekta	5/23
MAPA III	GRAĐEVINSKI PROJEKT KONSTRUKCIJE BETONSKA KONSTRUKCIJA
Projektant	KONSTRUKTA d.o.o. Antonio Maglov, dipl. ing. građ.
Broj projekta	T.D. 1906-06-IP
MAPA IV	GRAĐEVINSKI PROJEKT – PROJEKT VODOVODA I KANALIZACIJE
Projektant	TT INŽENJERING d.o.o. Branko Rod, struc. spec. ing. aedif.
Broj projekta	TD 69/22-VK-IZV-2
MAPA V	STROJARSKI PROJEKT – PROJEKT TERMOTEHNIČKIH INSTALACIJA I PLINA
Projektant	TT INŽENJERING d.o.o. Goran Tomek, dipl. ing. stroj.
Broj projekta	TD 69/22-VK-IZV-2

Izvadak iz registracije poduzeća

REPUBLIKA HRVATSKA
TRGOVAČKI SUD U ZAGREBU

IZVADAK IZ SUDSKOG REGISTRA

SUBJEKT UPISA

MBS:

080505281

OIB:

06674378579

TVRTKA:

4 KONSTRUKTA d.o.o. za graditeljstvo

4 KONSTRUKTA d.o.o.

SJEDIŠTE/ADRESA:

2 Zagreb (Grad Zagreb)
Desinička 20

PRAVNI OBLIK:

1 društvo s ograničenom odgovornošću

PREDMET POSLOVANJA:

1	70	- Poslovanje nekretninama
1	*	- Građenje, projektiranje i nadzor
1	*	- Kupnja i prodaja robe
1	*	- Obavljanje trgovačkog posredovanja na domaćem i inozemnom tržištu
1	*	- Obavljanje investicijskih radova u inozemstvu i povjeravanje investicijskih radova stranoj osobi u RH
1	*	- Zastupanje inozemnih tvrtki
6	*	- djelatnost energetskeg certificiranja i energetskeg pregleda zgrade
7	*	- savjetovanje u vezi s poslovanjem i upravljanjem
7	*	- organiziranje sajmova, priredbi, kongresa, promocija, zabavnih manifestacija, seminara, tečajeva, tribina i revija

OSNIVAČI/ČLANOVI DRUŠTVA:

3 Janko Šimanović, OIB: 66223427341
Zagreb, Magdićeve stube 1

4 - član društva

4 Antonio Maglov, OIB: 75189555710
Zagreb, Ede Murtića 6

4 - član društva

OSOBE OVLAŠTENE ZA ZASTUPANJE:

4 Antonio Maglov, OIB: 75189555710
Zagreb, Ede Murtića 6

4 - direktor

D004, 2018-02-13 08:50:16

Stranica: 1



SUBJEKT UPISA

OSOBE OVLAŠTENE ZA ZASTUPANJE:

- 4 - zastupa pojedinačno i samostalno, postao član uprave-
direktor Odlukom članova društva od 06.12.2012. godine
- 4 Janko Šimanović, OIB: 66223427341
Zagreb, Magdićeve stube 1
- 4 - prokurist

TEMELJNI KAPITAL:

- 5 720.000,00 kuna

PRAVNI ODNOSI:

Osnivački akt:

- 1 Društveni ugovor o osnivanju društva s ograničenom odgovornošću od 22.listopada 2004.godine.
- 3 Odlukom jedinog člana društva od 19.srpnja 2007.god. izmijenjen je Društveni ugovor od 22.listopada 2004.god. u preambuli - odredbe o osnivačima, čl.8.-odredbe o temeljnim ulozima i poslovnim udjelima a cijeli društveni ugovor stavljen je izvan snage i preimenovan u Izjavu o osnivanju koja se u tekstu od 19.srpnja 2007.god. dostavlja sudu i ulaže u zbirku isprava.
- 4 Izjava o osnivanju društva 19.07.2007. godine izmijenjena je odlukom članova društva od 06.12.2012. godine u potpunosti i preimenovana u Društveni ugovor, koji je u cijelosti dostavljen sudu i uložen u zbirku isprava.
- 5 Odlukom članova Društva od 19.03.2013.godine izmijenjen je Društveni ugovor u pogledu odredbe o temeljnom kapitalu i članovima društva - čl. 4. i 5., te je utvrđen potpuni tekst Društvenog ugovora koji je dostavljen sudu i uložen u zbirku isprava.
- 6 Odlukom članova društva od 31.01.2014. godine izmijenjen je Društveni ugovor u pogledu odredbe o predmetu poslovanja - čl. 3. i prijelaznim i završnim odredbama - čl. 24.-26. Tekst Društvenog ugovora dostavljen je sudu i uložen u zbirku isprava.
- 7 Odlukom članova društva od 15.12.2015. godine izmijenjen je Društveni ugovor u pogledu odredbe o predmetu poslovanja - čl.3., brisan je čl.21., a čl.22.-25. su postali čl.21.-24. Potpuni tekst Društvenog ugovora od 15.12.2015. godine dostavljen sudu u zbirku isprava.

Promjene temeljnog kapitala:

- 5 Odlukom članova Društva od 19.03.2013.godine povećan je temeljni kapital sa iznosa od 20.000,00 kuna za iznos od 700.000,00 kuna na iznos od 720.000,00 kuna, pretvaranjem rezervi iz dobiti u temeljni kapital.

FINANCIJSKA IZVJEŠĆA:

Predano	God.	Za razdoblje	Vrsta izvješća
eu 27.03.17	2016	01.01.16 - 31.12.16	GFI-ROD izvješćaj

D004, 2018-02-13 08:50:16

Stranica: 2 od 2



REPUBLIKA HRVATSKA
TRGOVAČKI SUD U ZAGREBU

IZVADAK IZ SUDSKOG REGISTRA

SUBJEKT UPISA

Upise u glavnu knjigu proveli su:

RBU Tt	Datum	Naziv suda
0001 Tt-04/10466-4	17.11.2004	Trgovački sud u Zagrebu
0002 Tt-06/10597-2	17.10.2006	Trgovački sud u Zagrebu
0003 Tt-07/8585-2	28.08.2007	Trgovački sud u Zagrebu
0004 Tt-12/19136-4	21.12.2012	Trgovački sud u Zagrebu
0005 Tt-13/9213-2	16.04.2013	Trgovački sud u Zagrebu
0006 Tt-14/3094-2	06.02.2014	Trgovački sud u Zagrebu
0007 Tt-15/37071-2	22.12.2015	Trgovački sud u Zagrebu
eu /	04.07.2009	elektronički upis
eu /	14.06.2010	elektronički upis
eu /	23.03.2011	elektronički upis
eu /	28.03.2012	elektronički upis
eu /	26.03.2013	elektronički upis
eu /	24.03.2014	elektronički upis
eu /	23.03.2015	elektronički upis
eu /	04.03.2016	elektronički upis
eu /	27.03.2017	elektronički upis

U Zagrebu, 13. veljače 2018.



Rješenje o upisu u Imenik ovlaštenih inženjera



REPUBLIKA HRVATSKA
HRVATSKA KOMORA ARHITEKATA
I INŽENJERA U GRADITELJSTVU

Klasa: UP/I-360-01/06-01/ 3775
Urbroj: 314-02-06-1
Zagreb, 17. srpnja 2006. godine

Na temelju članka 24. i članka 26. stavka 2. Zakona o Hrvatskoj komori arhitekata i inženjera u graditeljstvu ("Narodne novine", br. 47/98), Statuta Hrvatske komore arhitekata i inženjera u graditeljstvu ("Narodne novine", br. 147/05), te na temelju Odluke i nacrtu Rješenja Odbora za upis u Imenik ovlaštenih inženjera građevinarstva od 12.07.2006. godine, koji je rješavao po Zahtjevu za upis **MAGLOV ANTONIA**, dipl.ing.građ., ZAGREB, ZINKE KUNC 3 A, predsjednik Hrvatske komore arhitekata i inženjera u graditeljstvu donosi i potpisuje

RJEŠENJE

1. U **Imenik ovlaštenih inženjera građevinarstva** upisuje se **MAGLOV ANTONIO**, dipl.ing.građ., ZAGREB, pod rednim brojem **3775**, s danom upisa **12.07.2006.** godine.
2. Upisom u **Imenik ovlaštenih inženjera građevinarstva**, **MAGLOV ANTONIO**, dipl.ing.građ., stječe pravo na uporabu strukovnog naziva "**ovlašteni inženjer građevinarstva**" i pravo na obavljanje stručnih poslova temeljem članka 25. Zakona o Hrvatskoj komori arhitekata i inženjera u graditeljstvu, a u svezi s člankom 4. stavkom 1., 4. i 5. Statuta Hrvatske komore arhitekata i inženjera u graditeljstvu, te ostala prava i dužnosti sukladno posebnim propisima.
3. Ovlašteni inženjer građevinarstva poslove iz točke 2. ovoga Rješenja dužan je obavljati stvarno i stalno, te sukladno temeljnim načelima i pravilima struke koje treba poštivati ovlašteni inženjer građevinarstva.
4. Ovlaštenom inženjeru građevinarstva Hrvatska komora arhitekata i inženjera u graditeljstvu izdaje "**inženjersku iskaznicu**" i "**pečat**", koji su trajno vlasništvo Komore.
5. Ovlašteni inženjer građevinarstva dobiva posredstvom Hrvatske komore arhitekata i inženjera u graditeljstvu policu osiguranja od profesionalne odgovornosti od odabranog osiguravatelja. Polica se izdaje za razdoblje od godinu dana i obnavlja svake godine. Premija osiguranja uračunata je u članarinu.
6. Ovlašteni inženjer građevinarstva dužan je plaćati Hrvatskoj komori arhitekata i inženjera u graditeljstvu članarinu i ostala davanja koja utvrde tijela Komore i Razreda, osim u slučaju mirovanja članstva, te pri prestanku članstva u Komori podmiriti sve dospjele financijske obveze prema istima.

Obrazloženje

MAGLOV ANTONIO, dipl.ing.građ., podnio je Zahtjev za upis u Imenik ovlaštenih inženjera građevinarstva.

Odbor za upis u Imenik ovlaštenih inženjera građevinarstva proveo je na sjednici održanoj 12.07.2006. godine postupak razmatranja dostavljenog potpunog Zahtjeva imenovanog, te je temeljem članka 24. stavka 2. i članka 26. stavka 2. Zakona o Hrvatskoj komori arhitekata i inženjera u graditeljstvu ("Narodne novine", br. 47/98), a u svezi s člankom 5. stavkom 2. i člankom 22. Statuta Hrvatske komore arhitekata i inženjera u graditeljstvu ("Narodne novine", br. 147/05), donio Odluku i nacrt Rješenja o upisu imenovanog u Imenik ovlaštenih inženjera građevinarstva. Nacrt Rješenja dostavljen je na potpis predsjedniku Komore.

Ovlašteni inženjer građevinarstva stekao je pravo na obavljanje poslova projektiranja i/ili stručnog nadzora građenja prema članku 49. Zakona o gradnji ("Narodne novine", br. 175/03 i 100/04) i članku 4. stavku 1. Statuta Hrvatske komore arhitekata i inženjera u graditeljstvu ("Narodne novine", br. 147/05), u svojstvu odgovorne osobe upisom u Imenik ovlaštenih inženjera građevinarstva Hrvatske komore arhitekata i inženjera u graditeljstvu i to pravo mu traje dok traje policica osiguranja od profesionalne odgovornosti, odnosno do izricanja stegovne kazne iz članka 30. Zakona o Hrvatskoj komori arhitekata i inženjera u graditeljstvu ("Narodne novine", br. 47/98), a u svezi s člankom 4. stavkom 4. i 5. Statuta Hrvatske komore arhitekata i inženjera u graditeljstvu ("Narodne novine", br. 147/05).

Ovlašteni inženjer građevinarstva, osim u slučaju mirovanja članstva, dobiva posredstvom Hrvatske komore arhitekata i inženjera u graditeljstvu policu osiguranja od profesionalne odgovornosti od odabranog osiguravatelja. Polica se izdaje za razdoblje od godinu dana i obnavlja svake godine. Premija osiguranja uračunata je u članarinu.

Upisom u Imenik ovlaštenih inženjera građevinarstva imenovani je stekao pravo na "pečat" i "inženjersku iskaznicu" koje mu izdaje Hrvatska komora arhitekata i inženjera u graditeljstvu, a koji su trajno vlasništvo Komore temeljem članka 4. stavka 2. i 3. Statuta Hrvatske komore arhitekata i inženjera u graditeljstvu ("Narodne novine", br. 147/05).

Sva prethodno navedena prava obvezuju ovlaštenog inženjera građevinarstva na redovno i uredno plaćanje članarine u skladu s člankom 31. Statuta Hrvatske komore arhitekata i inženjera u graditeljstvu ("Narodne novine", br. 147/05).

Ovlašteni inženjer građevinarstva može poslove projektiranja i/ili stručnog nadzora građenja prema članku 51., 52., 53. i 55. Zakona o gradnji ("Narodne novine", br. 175/03 i 100/04) obavljati samostalno u vlastitom uredu, zajedničkom uredu, projektantskom društvu, odnosno u pravnoj osobi registriranoj za tu djelatnost.

Ovlašteni inženjer građevinarstva dužan je u obavljanju poslova projektiranja i/ili stručnog nadzora građenja poštivati odredbe Zakona o gradnji i posebnih zakona, te osigurati da obavljanje poslova projektiranja i/ili stručnog nadzora bude u skladu s načelima i pravilima struke, koja treba poštivati ovlašteni inženjer građevinarstva.

Na temelju svega prethodno navedenog, riješeno je kao u dispozitivu ovoga Rješenja.

Pouka o pravnom lijeku

Protiv ovog Rješenja žalba nije dopuštena, ali se može pokrenuti upravni spor podnošenjem tužbe Upravnom sudu Republike Hrvatske, u roku od 30 dana od primitka ovog Rješenja.



Dostaviti:

1. ANTONIO MAGLOV, 10000 ZAGREB, ZINKE KUNC 3 A
2. U Zbirku isprava Komore
3. Pismohrana Komore

17

2. ARMATURNI NACRTI

TEMJELNA KONSTRUKCIJA SMJEŠTAINOG PAVILJONA NACRT SAVIJANJA ARMATURE DONJE ZONE M:1:50

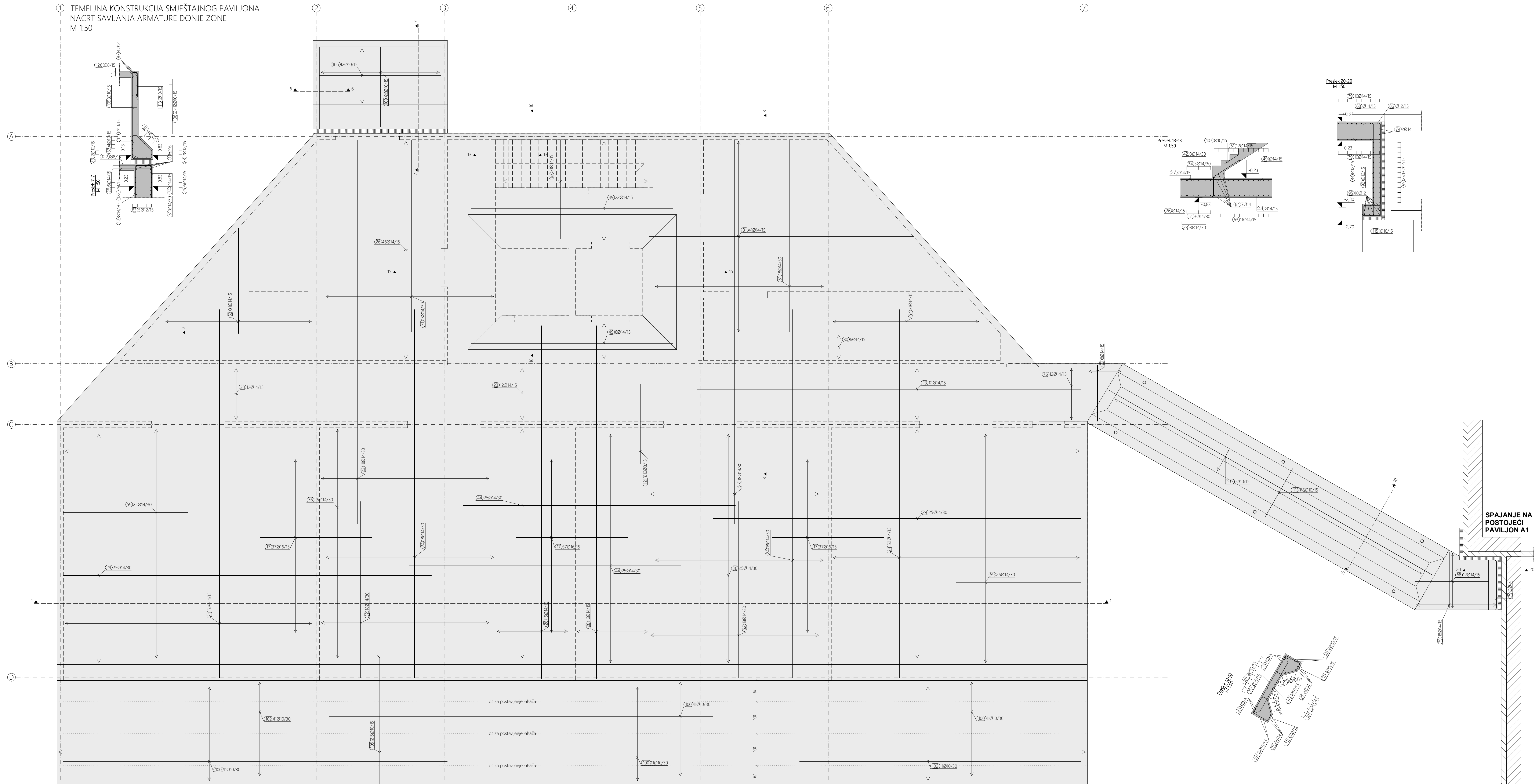

NAPOMENA!
Izvesti hadvišenje od 1 cm po rubu konz. ploče POS 601 pri postavljanju oplate.

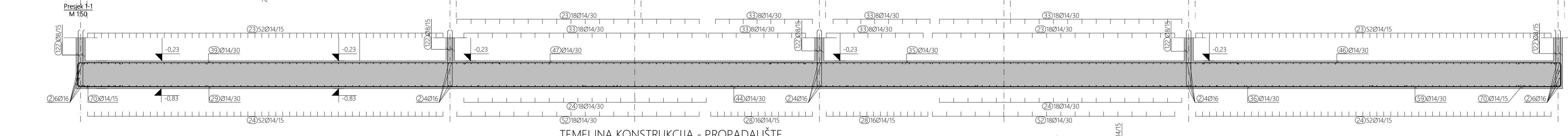

TEMJELNA KONSTRUKCIJA - PROPADALIŠTE M:1:50

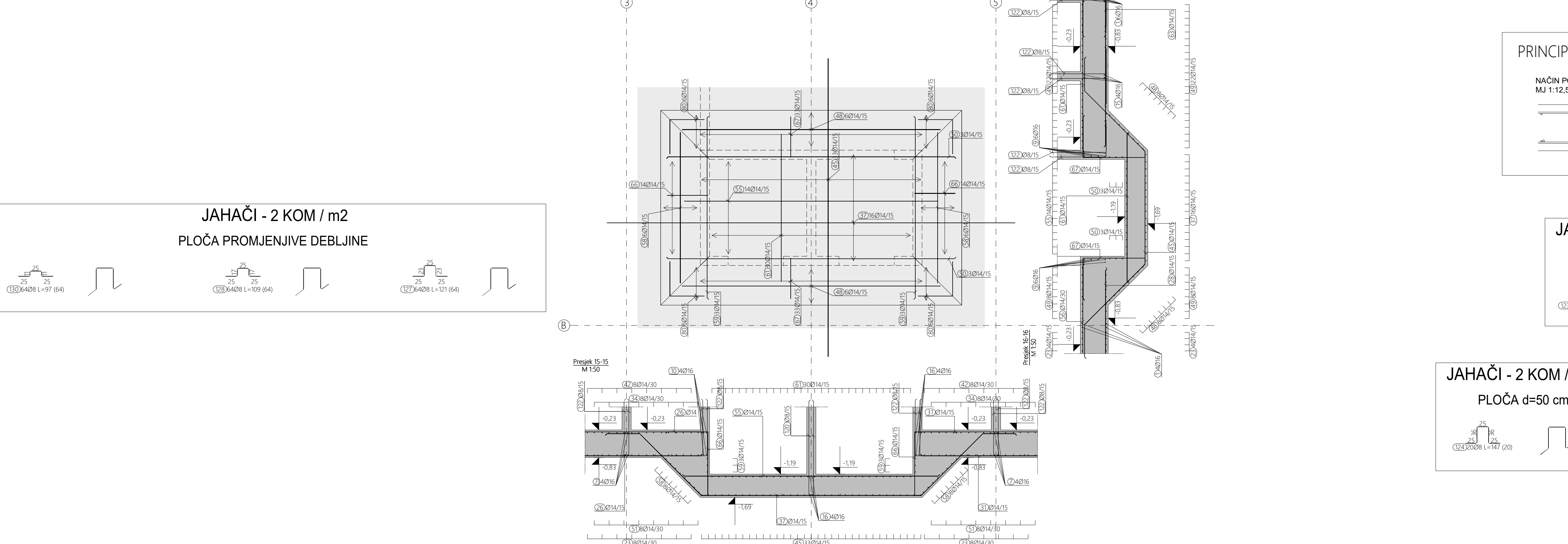

PRINCIPI POSTAVLJANJA JAHAČA
NAČIN POSTAVLJANJA JAHAČA
M:1:12,5

JAHAČI - 2 KOM / m2
PLOČA d=60 cm

JAHAČI - 2 KOM / m2
PLOČA d=50 cm

JAHAČI - 2 KOM / m2
PLOČA d=25 cm



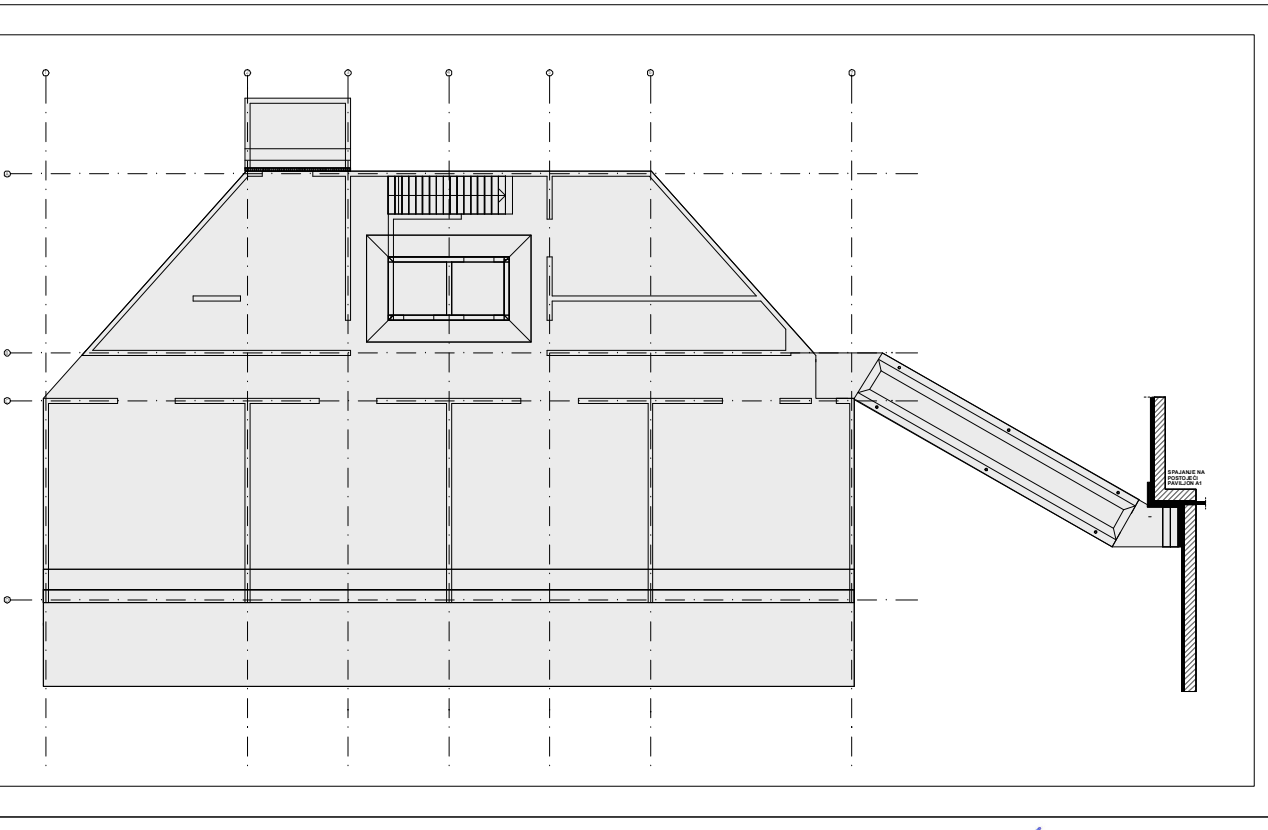

Svrha i specifikacija			
odlučni mjere			
Ø	L	h	Ø
Armaturna temeljna konstrukcija (1 kom)			
1	1000	16	12.00 52 624.00
2	155	16	12.00 24 288.00
3	155	16	10.55 6 63.30
4	130	16	10.30 2 20.60
5	130	16	10.20 2 20.40
6	130	16	9.70 16 155.20
7	80	16	8.05 6 64.40
8	80	16	6.55 2 13.10
9	80	16	6.40 16 101.60
10	330	16	5.85 4 23.40
11	400	16	5.50 6 33.00
12	400	16	5.25 6 31.50
13	50	16	5.05 2 10.10
14	490	16	4.90 4 19.60
15	450	16	4.90 4 19.60
16	490	16	4.10 6 24.60
17	80	16	3.50 12 42.00
18	155	16	2.40 12 28.80
19	80	16	2.20 14 30.80
20	80	16	2.15 4 8.60
21	80	16	2.50 6 15.00
22	80	16	1.80 4 7.20
23	80	16	1.80 4 7.20
24	155	16	12.00 224 2688.00
25	155	16	10.70 12 128.40
26	155	16	11.90 12 142.80
27	1000	14	12.00 86 1032.00
28	330	12	9.36 43 399.96
29	410	12	4.36 21 91.56
30	110	14	11.70 12 140.40
31	100	14	11.70 6 70.20
32	150	14	11.50 32 369.00
33	150	14	11.50 50 575.00
34	150	14	11.00 12 132.00
35	150	14	11.00 12 132.00
36	150	14	11.00 12 132.00
37	150	14	11.00 12 132.00
38	150	14	11.00 12 132.00
39	150	14	11.00 12 132.00
40	150	14	11.00 12 132.00
41	150	14	11.00 12 132.00
42	150	14	11.00 12 132.00
43	150	14	11.00 12 132.00
44	150	14	11.00 12 132.00
45	150	14	11.00 12 132.00
46	150	14	11.00 12 132.00
47	150	14	11.00 12 132.00
48	150	14	11.00 12 132.00
49	150	14	11.00 12 132.00
50	150	14	11.00 12 132.00
51	150	14	11.00 12 132.00
52	150	14	11.00 12 132.00
53	150	14	11.00 12 132.00
54	150	14	11.00 12 132.00
55	150	14	11.00 12 132.00
56	150	14	11.00 12 132.00
57	150	14	11.00 12 132.00
58	150	14	11.00 12 132.00
59	150	14	11.00 12 132.00
60	150	14	11.00 12 132.00
61	150	14	11.00 12 132.00
62	150	14	11.00 12 132.00
63	150	14	11.00 12 132.00
64	150	14	11.00 12 132.00
65	150	14	11.00 12 132.00
66	150	14	11.00 12 132.00
67	150	14	11.00 12 132.00
68	150	14	11.00 12 132.00
69	150	14	11.00 12 132.00
70	150	14	11.00 12 132.00
71	150	14	11.00 12 132.00
72	150	14	11.00 12 132.00
73	150	14	11.00 12 132.00
74	150	14	11.00 12 132.00
75	150	14	11.00 12 132.00
76	150	14	11.00 12 132.00
77	150	14	11.00 12 132.00
78	150	14	11.00 12 132.00
79	150	14	11.00 12 132.00
80	150	14	11.00 12 132.00
81	150	14	11.00 12 132.00
82	150	14	11.00 12 132.00
83	150	14	11.00 12 132.00
84	150	14	11.00 12 132.00
85	150	14	11.00 12 132.00
86	150	14	11.00 12 132.00
87	150	14	11.00 12 132.00
88	150	14	11.00 12 132.00
89	150	14	11.00 12 132.00
90	150	14	11.00 12 132.00
91	150	14	11.00 12 132.00
92	150	14	11.00 12 132.00
93	150	14	11.00 12 132.00
94	150	14	11.00 12 132.00
95	150	14	11.00 12 132.00
96	150	14	11.00 12 132.00
97	150	14	11.00 12 132.00
98	150	14	11.00 12 132.00
99	150	14	11.00 12 132.00
100	150	14	11.00 12 132.00
101	150	14	11.00 12 132.00
102	150	14	11.00 12 132.00
103	150	14	11.00 12 132.00
104	150	14	11.00 12 132.00
105	150	14	11.00 12 132.00
106	150	14	11.00 12 132.00
107	150	14	11.00 12 132.00
108	150	14	11.00 12 132.00
109	150	14	11.00 12 132.00
110	150	14	11.00 12 132.00
111	150	14	11.00 12 132.00
112	150	14	11.00 12 132.00
113	150	14	11.00 12 132.00
114	150	14	11.00 12 132.00

NAPOMENA
Šipke prilagoditi i po potrebi rezati na licu mjesta. Preklap 500.

Klasa betona		C 25/30	
Armatura		B 500 B	
Zaštitni sloj betona		Pripadajuća klasa armature	
dole	gore	bočno	ARM_TK_601-603_ISKAZ
4.0 cm	4.0 cm	4.0 cm	4.0 cm
Pripadajući armaturni nacrti			
ARM_TK_602-603			

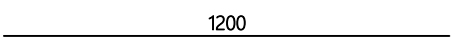
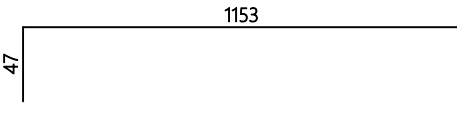
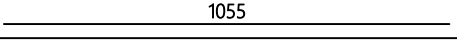
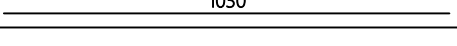
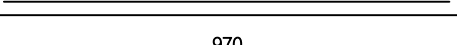
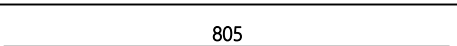
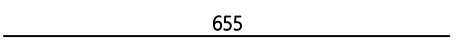
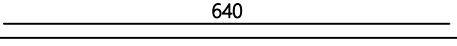
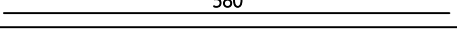
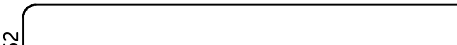
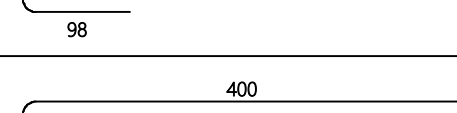

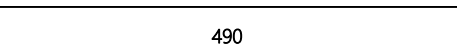
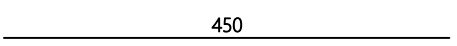
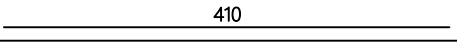
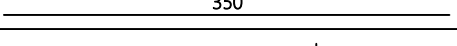
ISKAZ ARMATURE		
GRAĐEVINA:	REKONSTRUKCIJA TERMALNOG REKREACIJSKOG CENTRA TERME TUHELJ	
ISKAZ UZ NACRT:	ARM_TK_601-603_0	
SADRŽAJ:	ARMATURA TEMELJNE KONSTRUKCIJE	
DATUM:	lipanj, 2023.	1/11

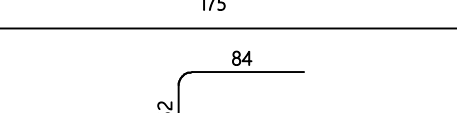
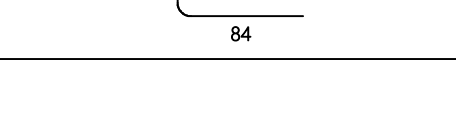
Šipke - specifikacija						
ozn	oblik i mjere [cm]	Ø	lg [m]	n [kom]	lgn [m]	Napomena
Armatura temeljne konstrukcije (1 kom)						
1		16	12.00	52	624.00	
2		16	12.00	24	288.00	
3		16	10.55	6	63.30	
4		16	10.30	2	20.60	
5		16	10.20	2	20.40	
6		16	9.70	16	155.20	
7		16	8.05	8	64.40	
8		16	6.55	2	13.10	
9		16	6.40	14	89.60	
10		16	5.80	4	23.20	
11		16	5.50	6	33.00	
12		16	5.25	6	31.50	
13		16	5.05	2	10.10	
14		16	4.90	4	19.60	
15		16	4.50	4	18.00	
16		16	4.10	8	32.80	
17		16	3.50	123	430.50	
18		16	2.40	12	28.80	
19		16	2.20	14	30.80	

ISKAZ ARMATURE

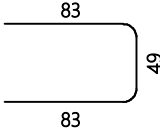
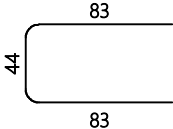
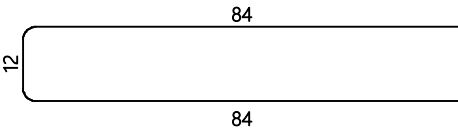
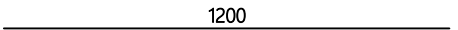
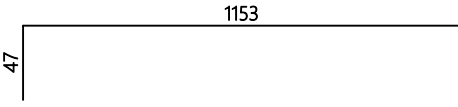
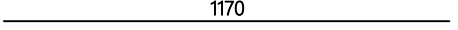
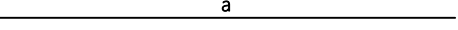
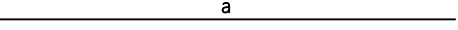
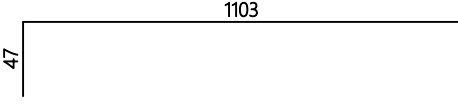
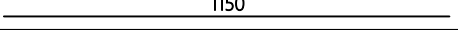
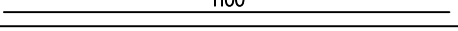
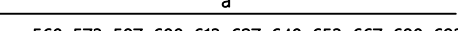

GRAĐEVINA:	REKONSTRUKCIJA TERMALNOG REKREACIJSKOG CENTRA TERME TUHELJ	
ISKAZ UZ NACRT:	ARM_TK_601-603_0	
SADRŽAJ:	ARMATURA TEMELJNE KONSTRUKCIJE	
DATUM:	lipanj, 2023.	2/11

Šipke - specifikacija						
ozn	oblik i mjere [cm]	Ø	lg [m]	n [kom]	lgn [m]	Napomena
20		16	2.15	4	8.60	
21		16	2.10	6	12.60	
22		16	1.80	4	7.20	
23		14	12.00	224	2688.00	
24		14	12.00	140	1680.00	
25		14	11.70	12	140.40	
26	 a = 560, 574, 587, 601, 614, 628, 641, 655, 668, 682, 695, 709, 722, 736, 749, 763, 776, 790, 803, 817, 831, 844, 858, 871, 885, 898, 912, 925, 939, 952, 966, 979, 993, 1006, 1020, 1033, 1047, 1060, 1074, 1087, 1101, 1115, 1128, 1142, 1155, 1169	14	*8.64	1 x 46	397.60	
27	 a = 560, 574, 587, 601, 614, 628, 641, 655, 668, 682, 695, 709, 722, 736, 749, 763, 776, 790, 803, 817, 831, 844, 858, 871, 885, 898, 912, 925, 939, 952, 966, 979, 993, 1006, 1020, 1033, 1047, 1060, 1074, 1087, 1101, 1115, 1128, 1142, 1155, 1169	14	*8.64	1 x 46	397.60	
28		14	11.50	32	368.00	
29		14	11.50	50	575.00	
30		14	11.00	12	132.00	
31	 a = 560, 573, 587, 600, 613, 627, 640, 653, 667, 680, 693, 707, 720, 733, 747, 760, 773, 787, 800, 813, 827, 840, 853, 867, 880, 893, 907, 920, 933, 947, 960, 973, 987, 1000, 1013, 1027, 1040, 1053, 1067, 1080, 1093	14	*8.27	1 x 41	338.93	

ISKAZ ARMATURE		
GRAĐEVINA:	REKONSTRUKCIJA TERMALNOG REKREACIJSKOG CENTRA TERME TUHELJ	
ISKAZ UZ NACRT:	ARM_TK_601-603_0	
SADRŽAJ:	ARMATURA TEMELJNE KONSTRUKCIJE	
DATUM:	lipanj, 2023.	3/11

Šipke - specifikacija						
ozn	oblik i mjere [cm]	Ø	lg [m]	n [kom]	lgn [m]	Napomena
32	<p style="text-align: center;">a</p> <p>a = 560, 573, 587, 600, 613, 627, 640, 653, 667, 680, 693, 707, 720, 733, 747, 760, 773, 787, 800, 813, 827, 840, 853, 867, 880, 893, 907, 920, 933, 947, 960, 973, 987, 1000, 1013, 1027, 1040, 1053, 1067, 1080, 1093</p>	14	*8.27	1 x 41	338.93	
33	1055	14	10.55	68	717.40	
34	1035	14	10.35	36	372.60	
35	1010	14	10.10	50	505.00	
36	1000	14	10.00	50	500.00	
37		14	9.95	16	159.20	
38	<p style="text-align: center;">a</p> <p>a = 770, 784, 797, 810, 823, 836, 849, 862, 875, 888, 901, 914</p>	14	*8.42	1 x 12	101.09	
39	895	14	8.95	50	447.50	
40	<p style="text-align: center;">a</p> <p>a = 750, 764, 777, 790, 803, 816, 829, 842, 855, 868, 881, 894</p>	14	*8.22	1 x 12	98.69	
41	<p style="text-align: center;">a</p> <p>a = 890, 873, 857, 840, 823, 807, 790, 773, 756, 740, 723, 706, 690, 673, 656, 640, 623, 606, 590, 573, 556, 540, 523, 506, 489, 473, 456, 439, 423, 406, 389, 373, 356, 339, 323, 306, 289, 272, 256, 239, 222, 206, 189, 172</p>	14	*5.31	1 x 44	233.71	
42	890	14	8.90	36	320.40	
43	<p style="text-align: center;">a</p> <p>a = 868, 852, 835, 819, 802, 785, 769, 752, 736, 719, 702, 686, 669, 653, 636, 619, 603, 586, 570, 553, 537, 520, 503, 487, 470, 454, 437, 420, 404, 387, 371, 354, 337, 321, 304, 288, 271, 254, 238, 221, 205, 188, 172, 155, 138, 122, 105, 89, 72</p>	14	*4.70	1 x 49	230.38	
44	850	14	8.50	50	425.00	
45		14	7.55	33	249.15	
46	755	14	7.55	50	377.50	
47	730	14	7.30	50	365.00	

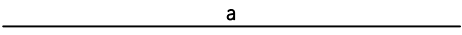
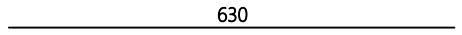
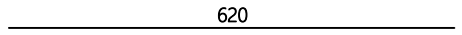
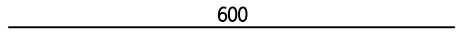
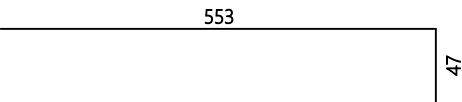
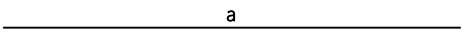
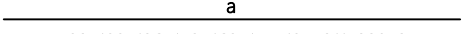
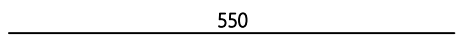
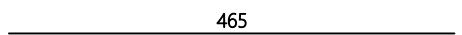
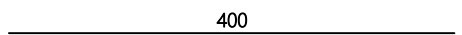
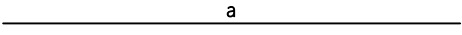
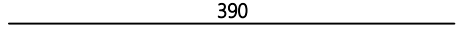
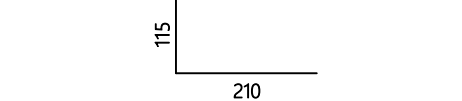

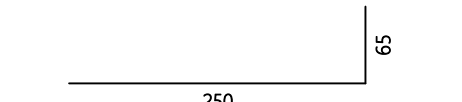
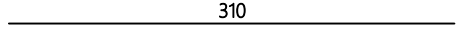
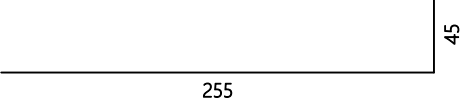

ISKAZ ARMATURE		
GRAĐEVINA:	REKONSTRUKCIJA TERMALNOG REKREACIJSKOG CENTRA TERME TUHELJ	
ISKAZ UZ NACRT:	ARM_TK_601-603_0	
SADRŽAJ:	ARMATURA TEMELJNE KONSTRUKCIJE	
DATUM:	lipanj, 2023.	4/11

Šipke - specifikacija						
ozn	oblik i mjere [cm]	Ø	lg [m]	n [kom]	lgn [m]	Napomena
48	 2 x : a = 487, 516, 545, 574, 602, 631	14	*5.59	2 x 6	67.10	
49		14	6.30	60	378.00	
50		14	6.20	6	37.20	
51		14	6.00	36	216.00	
52		14	6.00	36	216.00	
53	 a = 584, 567, 550, 533, 516, 499, 482, 465, 448, 431, 414, 397, 381, 364, 347, 330, 313, 296, 279, 262, 245, 228, 211, 194, 177, 160, 143, 126, 109, 92, 75	14	*3.30	1 x 31	102.18	
54	 a = 75, 92, 109, 126, 143, 160, 177, 194, 211, 228, 245, 262, 279, 296, 313, 330, 347, 364, 381, 397, 414, 431, 448, 465, 482, 499, 516, 533, 550, 567, 584	14	*3.30	1 x 31	102.18	
55		14	5.50	14	77.00	
56		14	4.65	32	148.80	
57		14	4.00	212	848.00	
58	 2 x : a = 256, 284, 313, 342, 370, 399	14	*3.27	2 x 6	39.28	
59		14	3.90	56	218.40	
60		14	3.25	430	1397.50	
61		14	3.20	62	198.40	
62		14	3.15	8	25.20	
63		14	3.10	31	96.10	
64		14	3.00	7	21.00	

ISKAZ ARMATURE

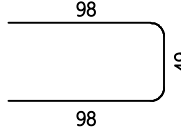
GRAĐEVINA:	REKONSTRUKCIJA TERMALNOG REKREACIJSKOG CENTRA TERME TUHELJ	
ISKAZ UZ NACRT:	ARM_TK_601-603_0	
SADRŽAJ:	ARMATURA TEMELJNE KONSTRUKCIJE	
DATUM:	lipanj, 2023.	5/11

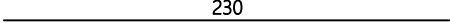
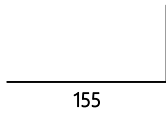
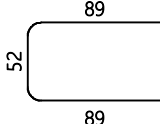
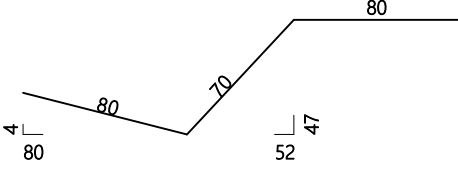
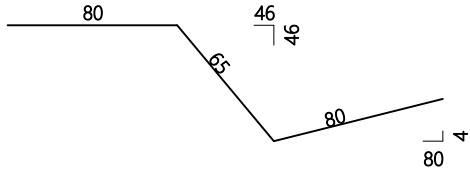
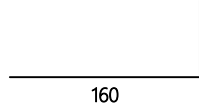
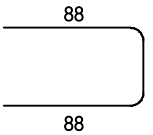
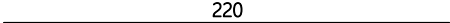
Šipke - specifikacija

ozn	oblik i mjere [cm]	Ø	lg [m]	n [kom]	lgn [m]	Napomena
65		14	2.45	99	242.55	
66		14	2.40	28	67.20	
67		14	2.35	66	155.10	
68		14	2.30	24	55.20	
69		14	2.30	430	989.00	
70		14	2.30	199	457.70	
71		14	2.30	14	32.20	
72		14	2.25	15	33.75	
73		14	2.25	233	524.25	
74		14	2.25	145	326.25	
75		14	2.20	12	26.40	
76		14	2.00	12	24.00	

ISKAZ ARMATURE		
GRAĐEVINA:	REKONSTRUKCIJA TERMALNOG REKREACIJSKOG CENTRA TERME TUHELJ	
ISKAZ UZ NACRT:	ARM_TK_601-603_0	
SADRŽAJ:	ARMATURA TEMELJNE KONSTRUKCIJE	
DATUM:	lipanj, 2023.	6/11

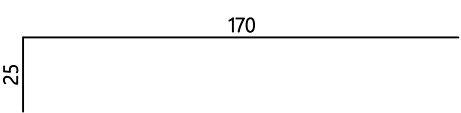
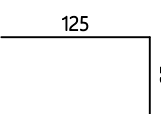
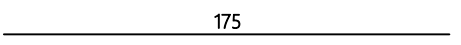
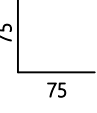
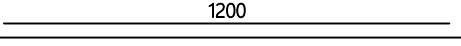
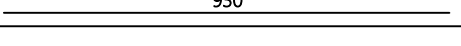
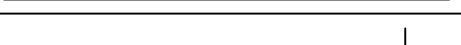
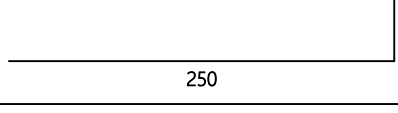
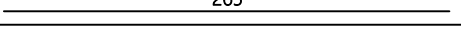
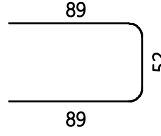
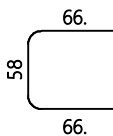
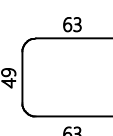
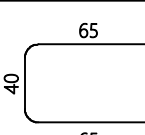
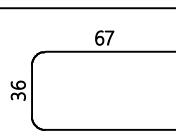
Šipke - specifikacija						
ozn	oblik i mjere [cm]	Ø	lg [m]	n [kom]	lgn [m]	Napomena
77		14	1.95	8	15.60	
78		14	1.90	8	15.20	
79		14	1.75	65	113.75	
80		14	1.50	24	36.00	
81		12	12.00	86	1032.00	
82		12	9.30	43	399.90	
83		12	4.10	21	86.10	
84		12	3.00	22	66.00	
85		12	2.65	8	21.20	
86		12	2.30	11	25.30	
87		12	1.90	6	11.40	
88		12	1.75	2	3.50	
89		12	1.70	18	30.60	
90		12	1.70	2	3.40	

ISKAZ ARMATURE

GRAĐEVINA:	REKONSTRUKCIJA TERMALNOG REKREACIJSKOG CENTRA TERME TUHELJ	
ISKAZ UZ NACRT:	ARM_TK_601-603_0	
SADRŽAJ:	ARMATURA TEMELJNE KONSTRUKCIJE	
DATUM:	lipanj, 2023.	7/11

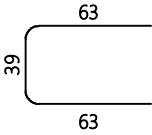
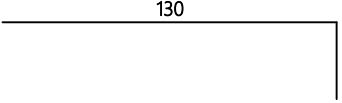
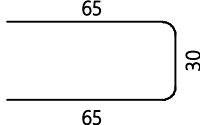
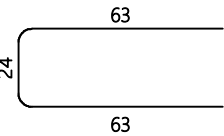
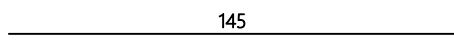
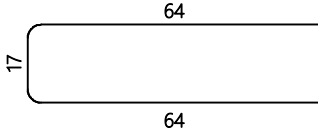
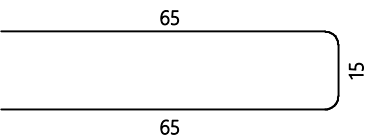
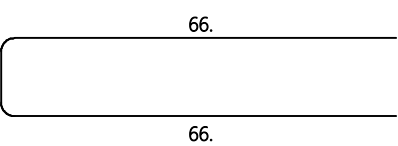
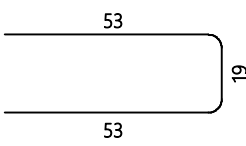
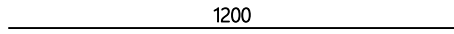
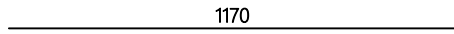
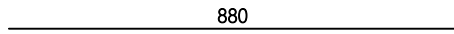
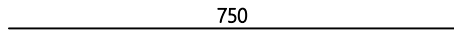
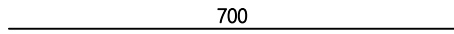
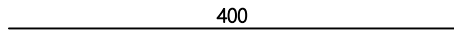
Šipke - specifikacija						
ozn	oblik i mjere [cm]	Ø	lg [m]	n [kom]	lgn [m]	Napomena
91		12	1.65	22	36.30	
92		12	1.60	22	35.20	
93		12	1.60	8	12.80	
94		12	1.50	2	3.00	
95		12	1.45	36	52.20	
96		12	1.45	4	5.80	
97		12	1.45	4	5.80	
98		12	1.45	2	2.90	
99		12	1.25	26	32.50	
100		10	12.00	88	1056.00	
101		10	11.70	27	315.90	
102		10	8.80	44	387.20	
103		10	7.50	100	750.00	
104		10	7.00	100	700.00	
105		10	4.00	215	860.00	

ISKAZ ARMATURE

GRAĐEVINA:	REKONSTRUKCIJA TERMALNOG REKREACIJSKOG CENTRA TERME TUHELJ		
ISKAZ UZ NACRT:	ARM_TK_601-603_0		
SADRŽAJ:	ARMATURA TEMELJNE KONSTRUKCIJE		
DATUM:	lipanj, 2023.	8/11	

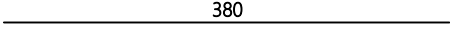
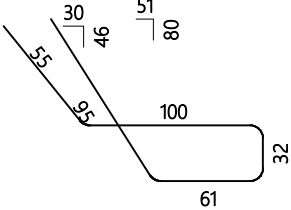
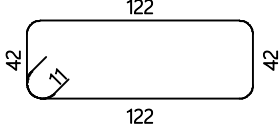
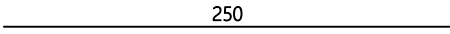
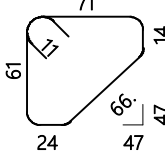
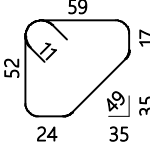
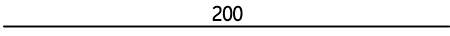
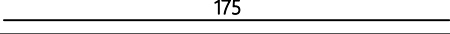
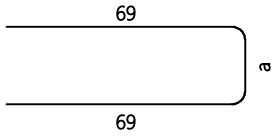
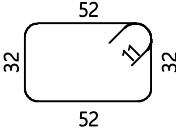
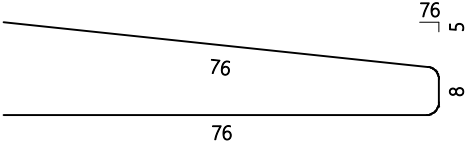
Šipke - specifikacija						
ozn	oblik i mjere [cm]	Ø	lg [m]	n [kom]	lgn [m]	Napomena
106		10	3.80	24	91.20	
107		10	3.43	10	34.30	
108		10	3.50	215	752.50	
109		10	2.50	52	130.00	
110		10	2.58	28	72.24	
111		10	2.23	150	334.50	
112		10	2.00	75	150.00	
113		10	1.75	75	131.25	
114	 2 x: a = 32, 31, 30, 29, 28, 27, 26, 26, 25, 24, 23, 22, 21, 20, 19, 18, 18, 17, 16, 15, 14, 13	10	*1.60	2 x 22	70.60	
115		10	1.90	11	20.90	
116		10	1.60	212	339.20	

ISKAZ ARMATURE	
GRAĐEVINA:	REKONSTRUKCIJA TERMALNOG REKREACIJSKOG CENTRA TERME TUHELJ
ISKAZ UZ NACRT:	ARM_TK_601-603_0
SADRŽAJ:	ARMATURA TEMELJNE KONSTRUKCIJE
DATUM:	lipanj, 2023. 9/11

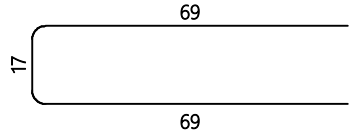
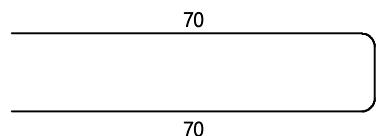
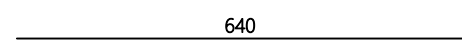
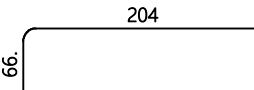
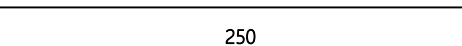
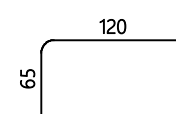
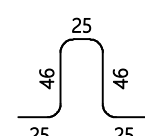
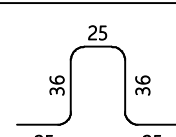
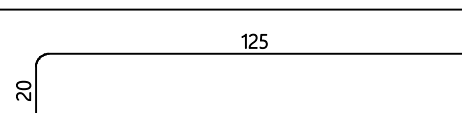
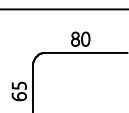
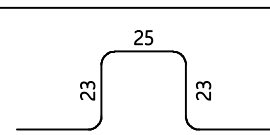
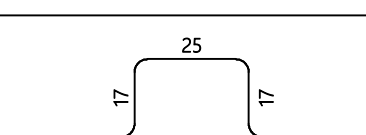
Šipke - specifikacija						
ozn	oblik i mjere [cm]	Ø	lg [m]	n [kom]	lgn [m]	Napomena
117		10	1.55	24	37.20	
118		10	1.55	26	40.30	
119		8	6.40	70	448.00	
120		8	2.70	28	75.60	
121		8	2.50	212	530.00	
122		8	1.85	1798	3326.30	
123		8	1.67	844	1409.48	
124		8	1.47	20	29.40	
125		8	1.45	16	23.20	
126		8	1.45	100	145.00	
127		8	1.21	64	77.44	
128		8	1.09	64	69.76	

ISKAZ ARMATURE	
GRAĐEVINA:	REKONSTRUKCIJA TERMALNOG REKREACIJSKOG CENTRA TERME TUHELJ
ISKAZ UZ NACRT:	ARM_TK_601-603_0
SADRŽAJ:	ARMATURA TEMELJNE KONSTRUKCIJE
DATUM:	lipanj, 2023. 10/11

Šipke - specifikacija						
ozn	oblik i mjere [cm]	Ø	lg [m]	n [kom]	lgn [m]	Napomena
129		8	1.01	34	34.34	
130		8	0.97	64	62.08	

ISKAZ ARMATURE		
GRAĐEVINA:	REKONSTRUKCIJA TERMALNOG REKREACIJSKOG CENTRA TERME TUHELJ	
ISKAZ UZ NACRT:	ARM_TK_601-603_0	
SADRŽAJ:	ARMATURA TEMELJNE KONSTRUKCIJE	
DATUM:	lipanj, 2023.	11/11

Šipke - rekapitulacija			
Ø [mm]	lgn [m]	Jedinična težina [kg/m']	Težina [kg]
B500B			
8	6230.60	0.40	2461.09
10	6273.29	0.62	3870.62
12	1865.90	0.89	1656.92
14	19461.57	1.21	23548.50
16	2025.30	1.58	3199.97
Ukupno (B500B)			34737.10
Ukupno			34737.10

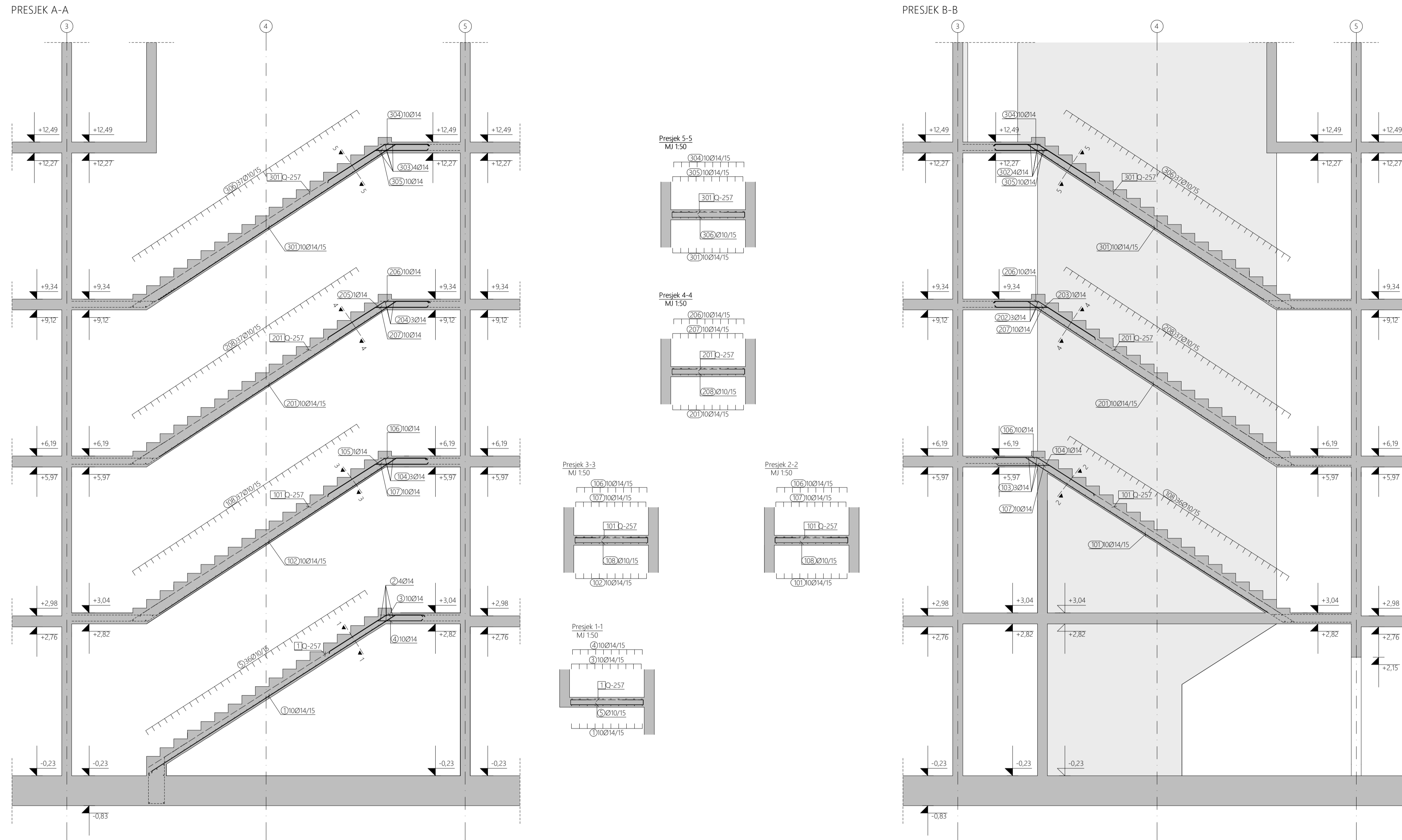

JAHAČI - 2 KOM / m²
PLOČA 2. KAT d=26,3 cm

JAHAČI - 2 KOM / m²
PLOČA 1. KAT d=26,3 cm

JAHAČI - 2 KOM / m²
PLOČA PRIZ. d=26,3 cm

JAHAČI - 2 KOM / m²
PLOČA SUTEREN d=20 cm

JAHAČI - 2 KOM / m²
PLOČA 2. KAT d=20 cm

JAHAČI - 2 KOM / m²
PLOČA 1. KAT d=20 cm

JAHAČI - 2 KOM / m²
PLOČA PRIZ. d=20 cm

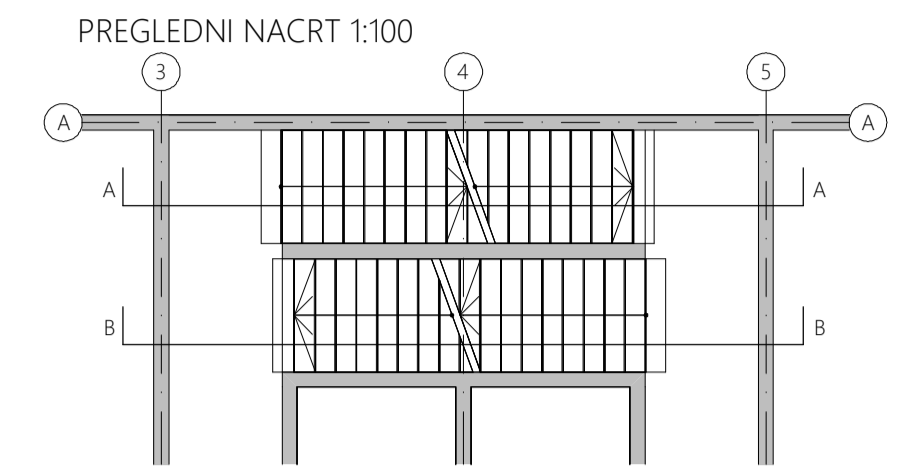

NAPOMENA
Šipke prilagoditi i po potrebi rezati
na licu mjesta. Preklap 50Ø.

NAPOMENA
Sve dimenzije provjeriti prema
važećim planovima oplate.

Klasa betona	C 25/30		
Armatura	B 500 B		
Zaštitni sloj betona suterena			
dolje	gore	bočno	Pripadajuća lista armature: ARM_E-1_601_ISKAZ
4,0 cm	4,0 cm	4,0 cm	
Zaštitni sloj betona prizemlje - 2. kat			
dolje	gore	bočno	
3,0 cm	3,0 cm	3,0 cm	
Pripadajući armaturni nacrti			
ARM_E-1_601			

ozn.	oblik i mjere [cm]	Ø	lg [m]	n [kom]	lgn [m]
Armatura stubišta suterena od kote -0,23 do kote +3,04					
1		14	6,36	10	63,60
2		14	2,95	4	11,80
3		14	2,05	10	20,50
4		14	2,00	10	20,00
5		10	2,50	36	90,00
6		8	0,89	8	7,12

ozn.	oblik i mjere [cm]	Ø	lg [m]	n [kom]	lgn [m]
Armatura stubišta prizemlja od kote +3,04 do kote +6,19					
101		14	6,40	10	64,00
102		14	6,30	10	63,00
103		14	3,00	3	9,00
104		14	2,95	4	11,80
105		14	2,60	1	2,60
106		14	2,15	20	43,00
107		14	2,15	20	43,00
108		10	2,50	73	182,50
109		8	1,05	12	12,60
110		8	0,93	12	11,16

ozn.	oblik i mjere [cm]	Ø	lg [m]	n [kom]	lgn [m]
Armatura stubišta 1. kata od kote +6,19 do kote +9,34					
201		14	6,35	20	127,00
202		14	3,00	3	9,00
203		14	2,95	1	2,95
204		14	2,95	3	8,85
205		14	2,60	1	2,60
206		14	2,20	20	44,00
207		14	2,15	20	43,00
208		10	2,46	74	182,04
209		8	1,05	12	12,60
210		8	0,93	12	11,16

ozn.	oblik i mjere [cm]	Ø	lg [m]	n [kom]	lgn [m]
Armatura stubišta 2. kata od kote +9,19 do kote +12,49					
301		14	6,35	20	127,00
302		14	3,00	4	12,00
303		14	2,95	4	11,80
304		14	2,20	20	44,00
305		14	2,15	20	43,00
306		10	2,50	74	185,00
307		8	1,05	12	12,60
308		8	0,93	12	11,16

KONSTRUKTA
KONSTRUKTA d.o.o., za projektiranje i nadzor
Desinićeva 20, ZAGREB, OIB: 06674378579
ŽR: PRIVREDNA BANKA 2340009-1110164468
TEL: 01/36 43 828; FAX: 01/36 43 829
MAIL: info@konstrukta.hr

PEČAT I POTPIS:

Hrvatska Vlada
Antonio Maglov, dipl. ing. grad.
Ovlaštenje za projektiranje građevinarstva
03775

INVESTITOR: TERME TUHELJI d.o.o. Ljudevita Gaja 4, Tuhejske Toplice, 49215 Tuhej
GRAĐEVINA: REKONSTRUKCIJA TERMALNOG REKREACIJSKOG CENTRA TERME TUHELJI
LOKACIJA: na kč.br. 3199/1, k.o. Črešnjevec
FAZA: IZVEDBENI PROJEKT - ARMATURNI NACRTI
SADRŽAJ: ELEMENT - SMJEŠTAJNI PAVILJON ARMATURA STR. PLOČE SUTERENA RUBNA ARMATURA I ANKERI
GL. PROJEKTANT: Tomislav Vreš, dipl. ing. arh.
PROJEKT. IZV. PR: Antonio Maglov, dipl. ing. grad.
IZRADIO: Antonio Maglov, dipl. ing. grad.
DATUM: svibanj, 2023.
MJERILO: 1:50
REVIZIJA: 00
NACRT BR: ARM - E-1 - 601

ISKAZ ARMATURE		
GRAĐEVINA:	REKONSTRUKCIJA TERMALNOG REKREACIJSKOG CENTRA TERME TUHELJ	
ISKAZ UZ NACRT:	ARM_E-1_601	
SADRŽAJ:	ARMATURA STUBIŠTA SMJEŠTAJNOG PAVILJONA	
DATUM:	svibanj, 2023.	1/6

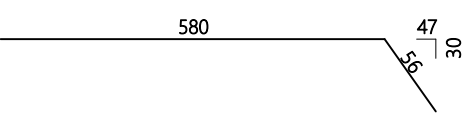
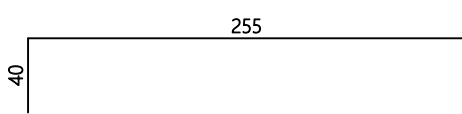
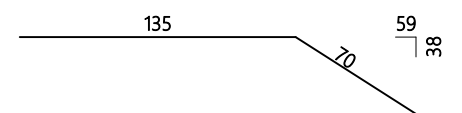
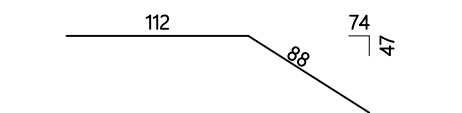
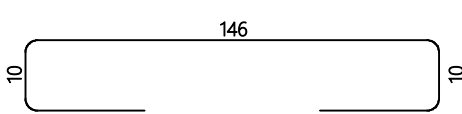
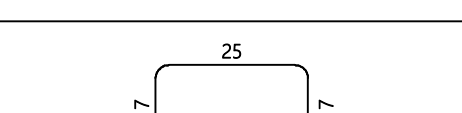
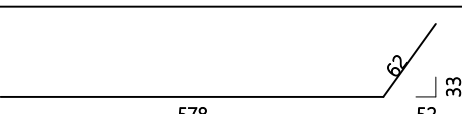
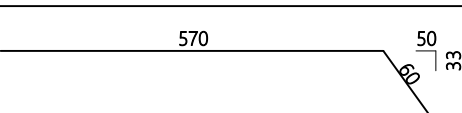
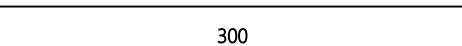
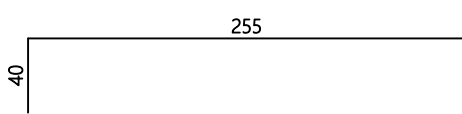
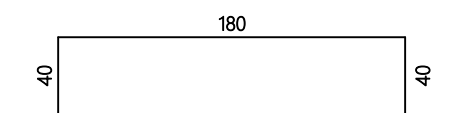
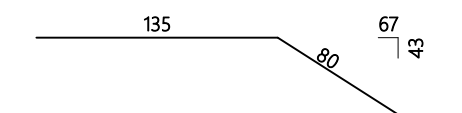
Šipke - specifikacija						
ozn	oblik i mjere [cm]	Ø	lg [m]	n [kom]	lgn [m]	Napomena
Armatura stubišta suterena od kote -0,23 do kote +3,04 (1 kom)						
1		14	6.36	10	63.60	
2		14	2.95	4	11.80	
3		14	2.05	10	20.50	
4		14	2.00	10	20.00	
5		10	2.50	36	90.00	
6		8	0.89	8	7.12	
Armatura stubišta prizemlja od kote +3,04 do kote +6,19 (1 kom)						
101		14	6.40	10	64.00	
102		14	6.30	10	63.00	
103		14	3.00	3	9.00	
104		14	2.95	4	11.80	
105		14	2.60	1	2.60	
106		14	2.15	20	43.00	

ISKAZ ARMATURE

GRAĐEVINA:	REKONSTRUKCIJA TERMALNOG REKREACIJSKOG CENTRA TERME TUHELJ		
ISKAZ UZ NACRT:	ARM_E-1_601		
SADRŽAJ:	ARMATURA STUBIŠTA SMJEŠTAJNOG PAVILJONA		
DATUM:	svibanj, 2023.	2/6	

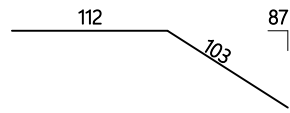
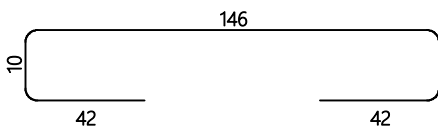
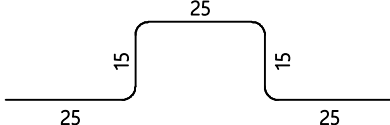
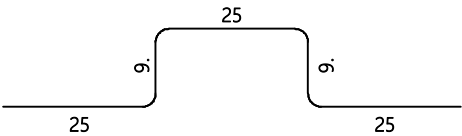
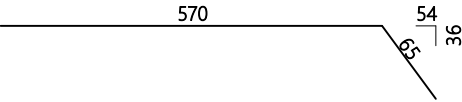
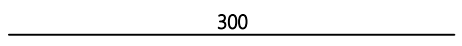
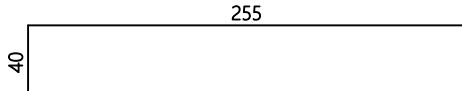
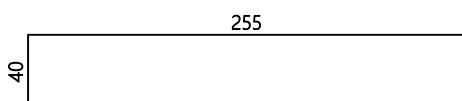
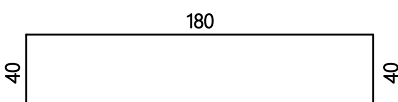
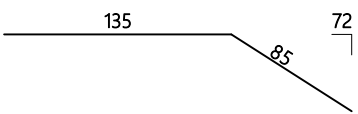
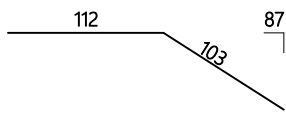
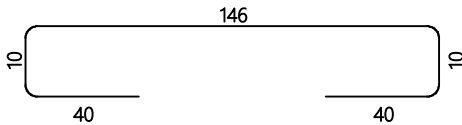
Šipke - specifikacija						
ozn	oblik i mjere [cm]	Ø	lg [m]	n [kom]	lgn [m]	Napomena
107		14	2.15	20	43.00	
108		10	2.50	73	182.50	
109		8	1.05	12	12.60	
110		8	0.93	12	11.16	
Armatura stubišta 1. kata od kote +6,19 do kote +9,34 (1 kom)						
201		14	6.35	20	127.00	
202		14	3.00	3	9.00	
203		14	2.95	1	2.95	
204		14	2.95	3	8.85	
205		14	2.60	1	2.60	
206		14	2.20	20	44.00	
207		14	2.15	20	43.00	
208		10	2.46	74	182.04	

ISKAZ ARMATURE		
GRAĐEVINA:	REKONSTRUKCIJA TERMALNOG REKREACIJSKOG CENTRA TERME TUHELJ	
ISKAZ UZ NACRT:	ARM_E-1_601	
SADRŽAJ:	ARMATURA STUBIŠTA SMJEŠTAJNOG PAVILJONA	
DATUM:	svibanj, 2023.	3/6

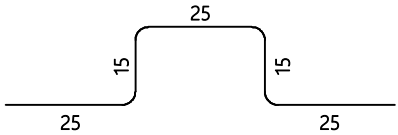
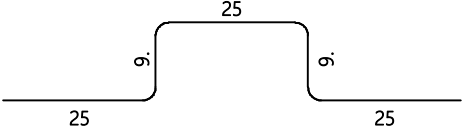
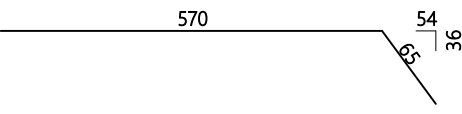
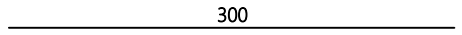
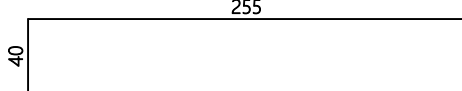
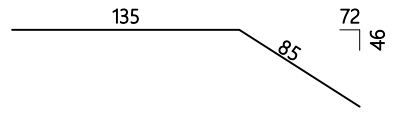
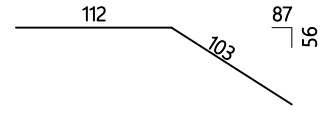
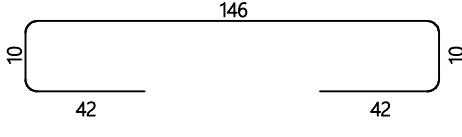
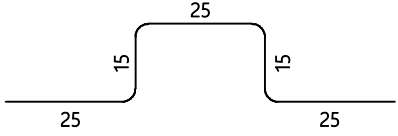
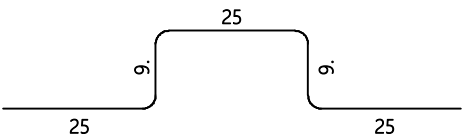
Šipke - specifikacija						
ozn	oblik i mjere [cm]	Ø	lg [m]	n [kom]	lgn [m]	Napomena
209		8	1.05	12	12.60	
210		8	0.93	12	11.16	
Armatura stubišta 2. kata od kote +9,19 do kote +12,49 (1 kom)						
301		14	6.35	20	127.00	
302		14	3.00	4	12.00	
303		14	2.95	4	11.80	
304		14	2.20	20	44.00	
305		14	2.15	20	43.00	
306		10	2.50	74	185.00	
307		8	1.05	12	12.60	
308		8	0.93	12	11.16	

ISKAZ ARMATURE	
GRAĐEVINA:	REKONSTRUKCIJA TERMALNOG REKREACIJSKOG CENTRA TERME TUHELJ
ISKAZ UZ NACRT:	ARM_E-1_601
SADRŽAJ:	ARMATURA STUBIŠTA SMJEŠTAJNOG PAVILJONA
DATUM:	svibanj, 2023. 4/6

Šipke - rekapitulacija			
Ø [mm]	lgn [m]	Jedinična težina [kg/m']	Težina [kg]
B500B			
8	78.40	0.40	30.97
10	639.54	0.62	394.60
14	827.50	1.21	1001.27
Ukupno (B500B)			1426.84
Ukupno			1426.84

ISKAZ ARMATURE	
GRAĐEVINA:	REKONSTRUKCIJA TERMALNOG REKREACIJSKOG CENTRA TERME TUHELJ
ISKAZ UZ NACRT:	ARM_E-1_601
SADRŽAJ:	ARMATURA STUBIŠTA SMJEŠTAJNOG PAVILJONA
DATUM:	svibanj, 2023. 5/6

Mreže - specifikacija							
Polozicija	Oznaka mreže	B [cm]	L [cm]	n	Jedinična težina [kg/m ²]	Ukupna težina [kg]	Napomena
Armatura stubišta suterena od kote -0,23 do kote +3,04 (1 kom)							
1-1	Q-257	150	567	1	4.12	35.04	
Ukupno						35.04	
Armatura stubišta prizemlja od kote +3,04 do kote +6,19 (1 kom)							
101-1	Q-257	150	576	2	4.12	71.19	
Ukupno						71.19	
Armatura stubišta 1. kata od kote +6,19 do kote +9,34 (1 kom)							
201-1	Q-257	150	576	2	4.12	71.19	
Ukupno						71.19	
Armatura stubišta 2. kata od kote +9,19 do kote +12,49 (1 kom)							
301-1	Q-257	150	576	2	4.12	71.19	
Ukupno						71.19	

ISKAZ ARMATURE		
GRAĐEVINA:	REKONSTRUKCIJA TERMALNOG REKREACIJSKOG CENTRA TERME TUHELJ	
ISKAZ UZ NACRT:	ARM_E-1_601	
SADRŽAJ:	ARMATURA STUBIŠTA SMJEŠTAJNOG PAVILJONA	
DATUM:	svibanj, 2023.	6/6

Mreže - rekapitulacija						
Oznaka mreže	B [cm]	L [cm]	n	Jedinična težina [kg/m ²]	Ukupna težina [kg]	Neto ugrađena težina [kg]
Q-257	215	600	7	4.12	372.04	248.61
Ukupno					372.04	248.61

STROPNA PLOČA SUTERENA SMJEŠTAJNOG PAVILIONA
NACRT SAVIJANJA ARMATURE DONJE ZONE
M 1:50

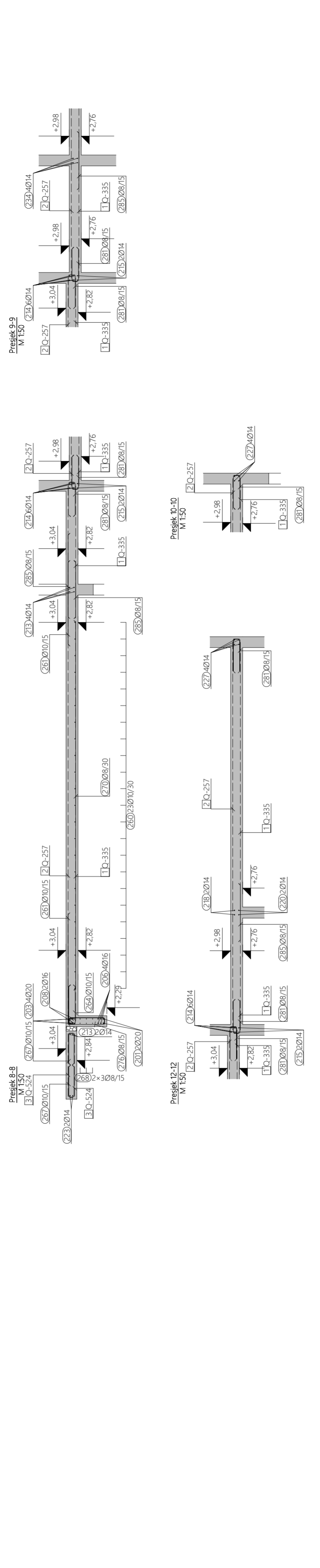
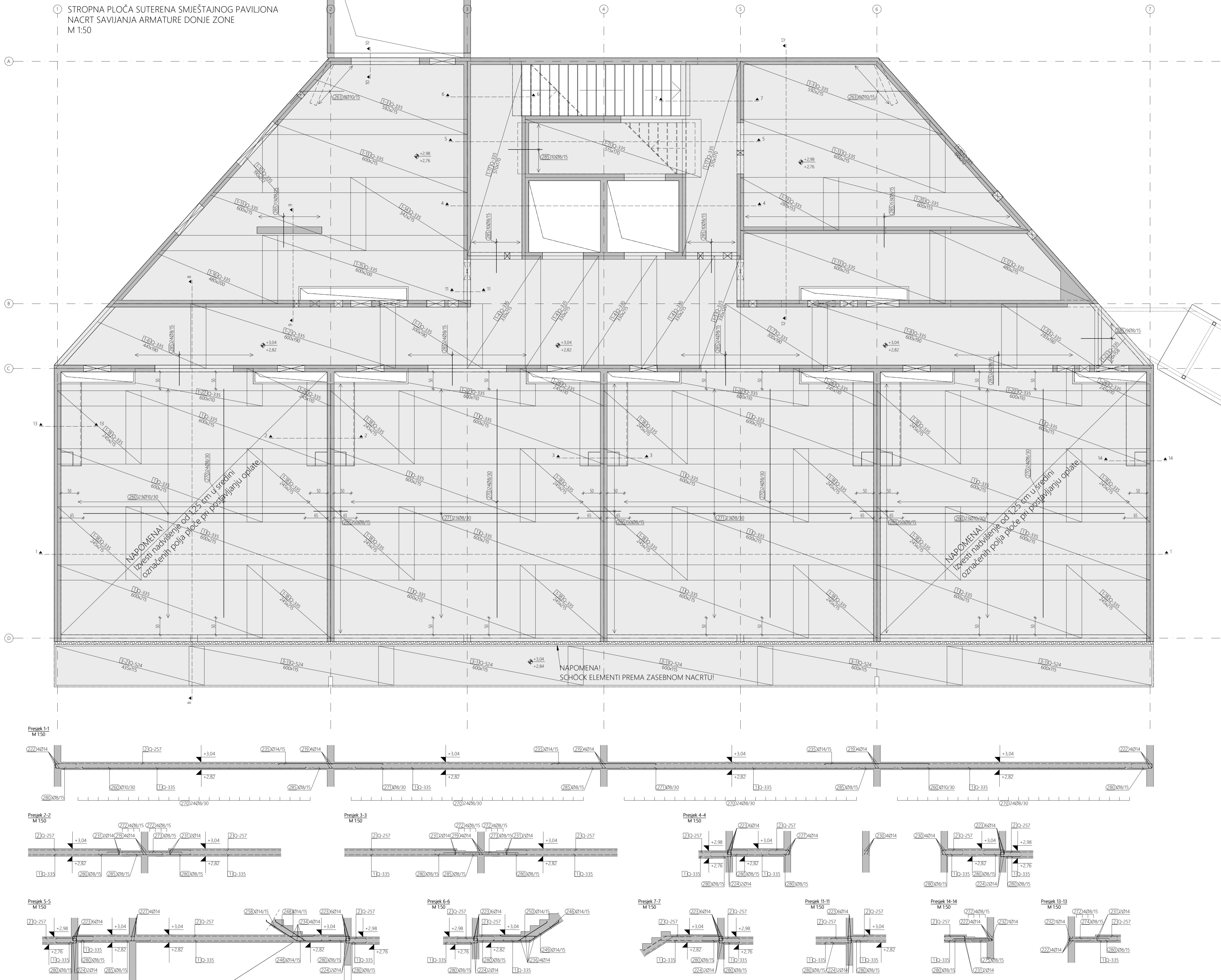

Šipke - specifikacija		Ø	lg	n	lgn
oblik i mjere (mm)	lign	(mm)	(mm)	(kom)	(m)
Armatura stropne ploče suterena (1 kom)					
20	1200	2	2400		
20	1200	6	7200		
20	1200	4	4800		
20	1140	2	2280		
20	1140	4	4560		
16	1200	4	4800		
16	1200	6	7200		
16	1200	2	2400		
16	1070	4	4280		
16	1070	2	2140		
16	350	48	9600		
14	1200	22	26400		
14	1120	12	13440		
14	1045	4	4180		
14	960	6	5760		
14	950	6	5700		
14	925	2	1850		
14	875	12	10500		
14	850	2	1700		
14	810	2	1620		
14	805	8	6440		
14	795	16	12720		
14	720	4	2880		
14	620	8	4960		
14	595	6	3570		
14	485	12	5820		
14	460	8	3680		
14	450	2	900		
14	390	8	3120		
14	370	16	5920		
14	365	2	730		
14	340	4	1360		
14	330	8	2640		
14	300	99	29700		
14	295	4	1180		
14	290	6	1740		
14	290	6	1740		
14	280	4	1120		
14	275	16	4400		
14	210	8	1680		
14	200	8	1600		
14	195	32	6240		
14	195	31	6045		
14	190	8	1520		
14	180	10	1800		
14	180	4	720		
14	195	32	6240		
14	175	18	3150		
14	175	9	1575		
14	170	9	1530		
14	170	16	2720		

252	125	14	165	8	1320
253	165	14	165	4	660
254	74	14	165	14	2310
255	76	14	160	4	640
256	74	14	160	18	2880
257	75	14	160	17	2720
258	75	14	150	9	1350
259	69	12	150	80	12000
260	69	10	650	46	29900
261	200	10	200	304	60800
262	58	10	175	114	19950
263	105	10	175	16	2800
264	69	10	150	208	31200
265	67	10	140	32	4480
266	67	10	120	30	3600
267	54	10	120	30	3600
268	55	10	120	432	51840
269	55	8	1200	12	14400
270	890	8	890	6	5340
271	670	8	670	56	64320
272	650	8	650	46	29900
273	285	8	285	32	9120
274	215	8	215	51	10965
275	114	8	180	28	5040
276	65	8	172	208	35776
277	65	8	150	100	15000
278	69	8	150	100	15000
279	63	8	140	116	16240
280	58	8	130	450	58500
281	59	8	130	561	72930
282	48	8	134	6	804
283	42	8	122	49	5978
284	40	8	122	12	1464
285	40	8	100	447	44700
286	45	8	100	6	600
287	25	8	095	830	78850
288	25	8	091	80	7280
289	25	8	085	24	2040

JAHAČI - 2 KOM / m²
PLOČA d=22 cm

JAHAČI - 2 KOM / m²
PLOČA d=20 cm

JAHAČI - 2 KOM / m²
PLOČA d=16 cm

NAPOMENA
Šipke prilagoditi i po potrebi rezati na licu mjesta. Preklap 50Ø.

NAPOMENA
Sve dimenzije provjeriti prema važećim planovima optate.

Klasa betona	C 25/30
Armatura	B 500 B
Zaštitni sloj betona	4,0 cm
dijelje	gore
4,0 cm	bočno
4,0 cm	Pripadajuća lista armature:
	ARM_E-1.603-604.ISKAZ
Pripadajući armaturni nacrti	
ARM_E-1.603-604	

KONSTRUKTA PEČAT I POTPIS:

KONSTRUKTA d.o.o. za projektiranje i nadzor
Desinićka 20, ZAGREB, OIB: 0667437579
Zr: PRIVREDNA BANKA 2340009-1110164468
TEL: 0136 43 825; FAX: 0136 43 825
MAIL: info@konstrukt.hr

INVESTITOR: TERME TUHELJI d.o.o. Ujvedina Gaja 4, Tuhejske Toplice, 49275 Tuhej

GRADEVINA: REKONSTRUKCIJA TERMANOG REKREACIJSKOG CENTRA TERME TUHELJI

LOKACIJA: na k.č.br. 3199/1, k.o. Črešnjevec

FAZA: IZVEDBENI PROJEKT - ARMATURNI NACRTI

SADRŽAJ: ELEMENT - SMJEŠTAINI PAVILION ARMATURA STR. PLOČE SUTERENA DONJA ZONA

GL. PROJEKTANT: Tomislav Vrdel, dipl. ing. arh.

PROJEKT. IZV. PR: Antonio Maglov, dipl. ing. grad.

IZRADIO: Antonio Maglov, dipl. ing. grad.

DATUM: svibanj 2023.

MJERILO: 1:50

REVIZUAL: 00

NACRT BR: ARM - E-1 - 602

STROPNA PLOČA SUTERENA SMJEŠTAJNOG PAVILIONA
 NACRT SAVIJANJA ARMATURE GORNJE ZONE
 M 1:50

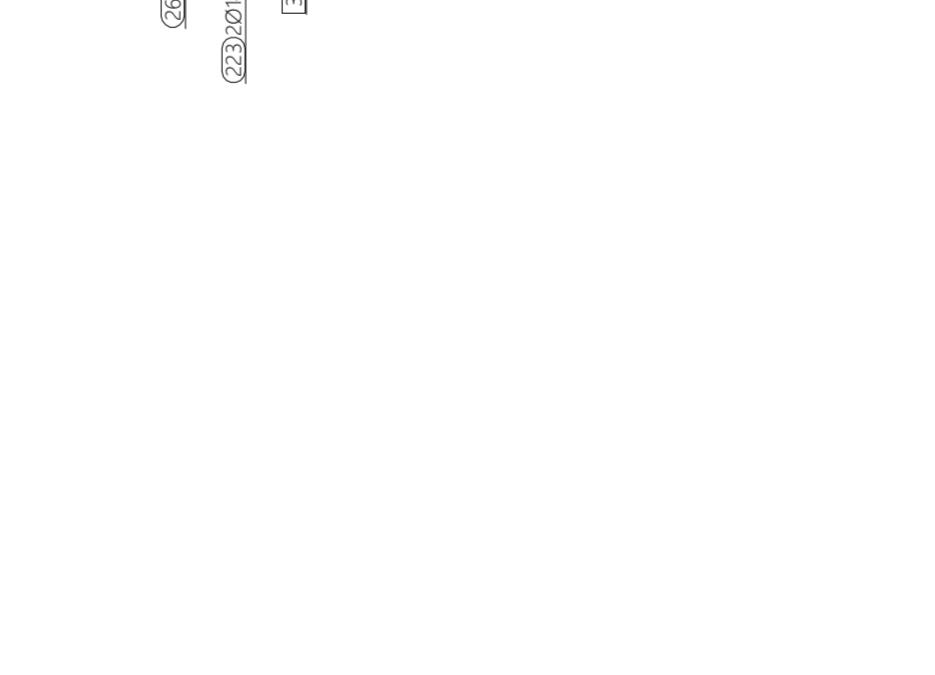
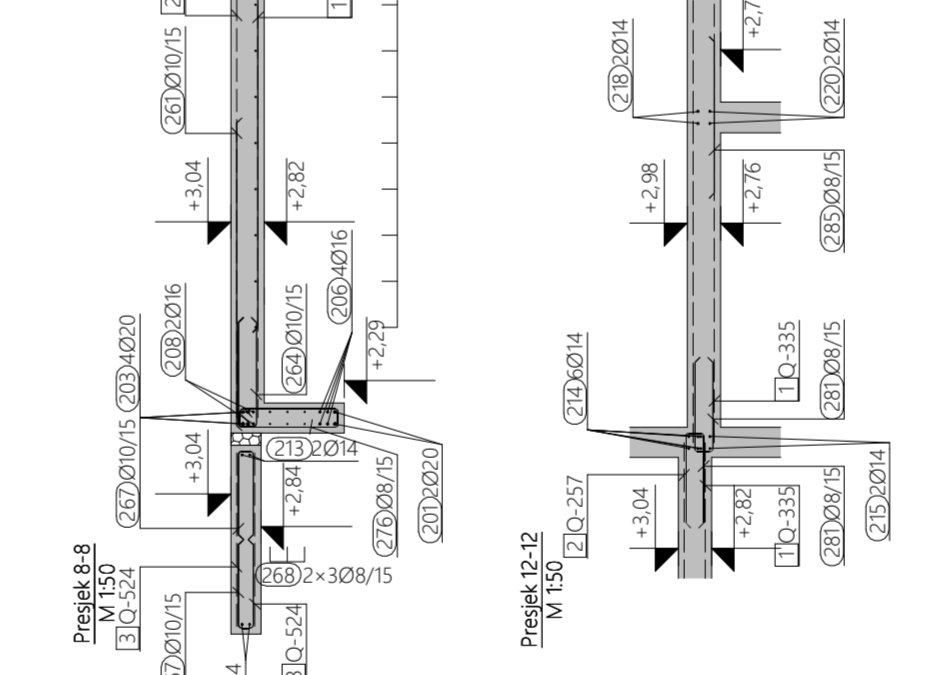
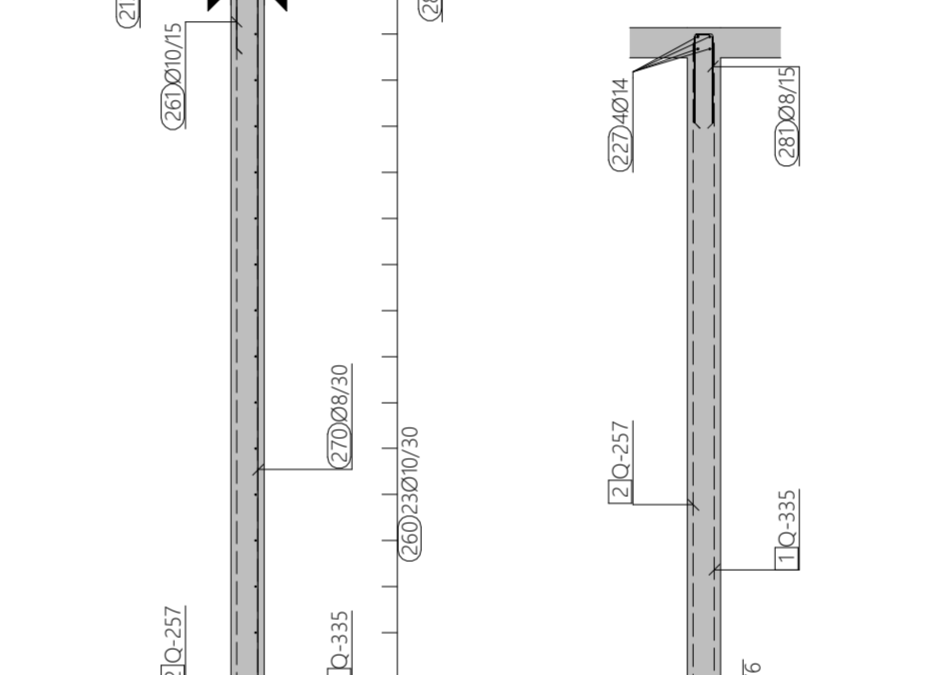
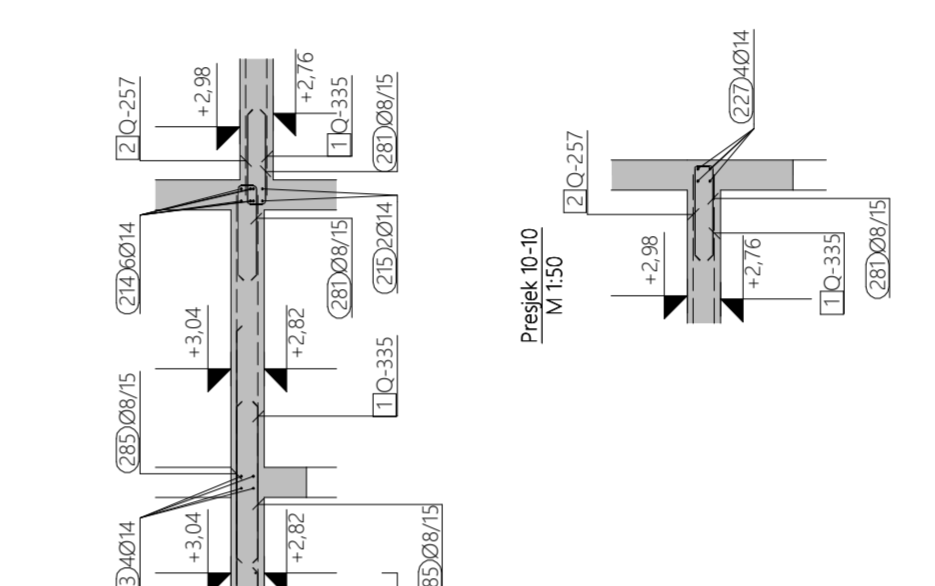
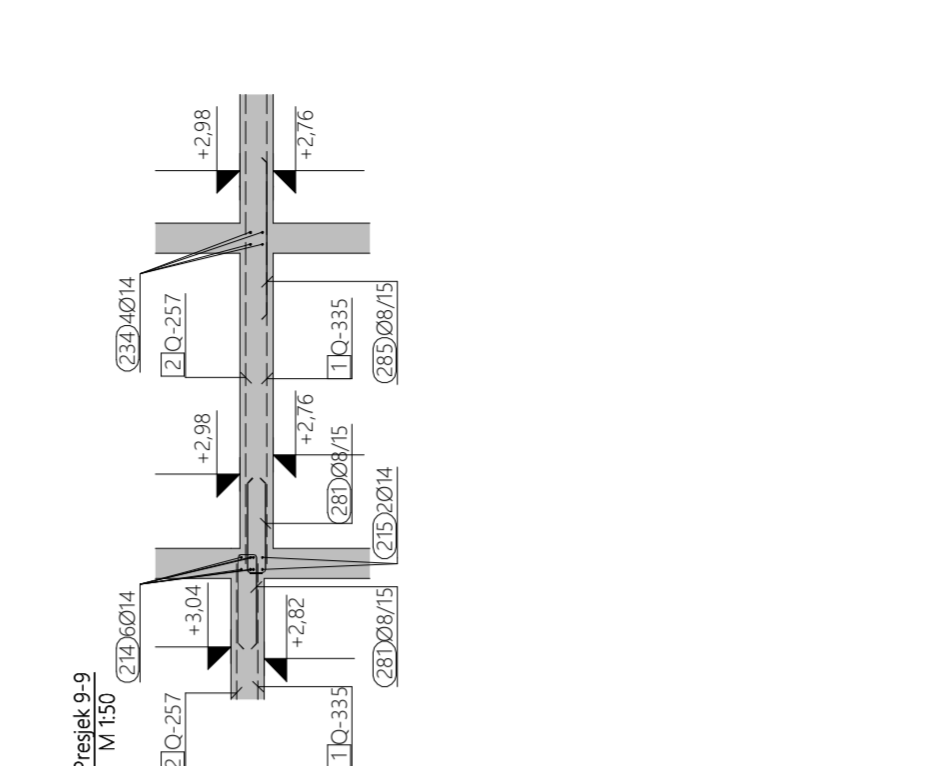
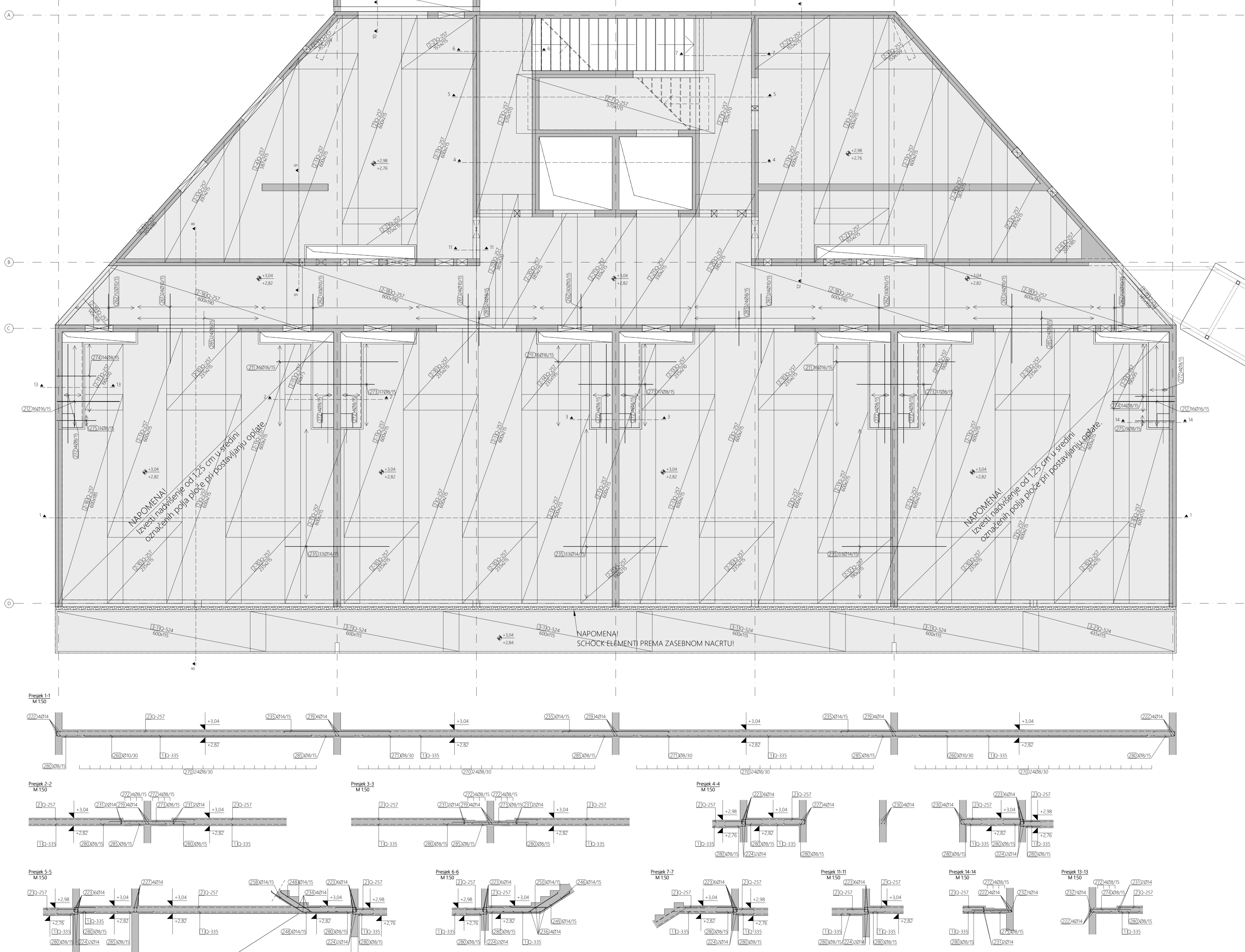

Šipke - specifikacija		Ø	lg	n	lgn
oblik i mjere (mm)	lign	(mm)	(mm)	(kom)	(m)
Armatura stropne ploče suterena (1 kom)					
201	65	10	12,00	2	24,00
202	100	10	12,00	6	72,00
203	65	10	12,00	4	48,00
204	100	10	11,40	2	22,80
205	100	10	11,40	4	45,60
206	50	10	12,00	4	48,00
207	80	10	12,00	6	72,00
208	50	10	12,00	2	24,00
209	80	10	10,70	4	42,80
210	50	10	10,70	2	21,40
211	100	10	3,50	48	168,00
212	80	10	2,65	30	84,80
213	100	14	12,00	22	264,00
214	100	14	11,20	12	134,40
215	1045	14	10,45	4	41,80
216	960	14	9,60	6	57,60
217	950	14	9,50	6	57,00
218	925	14	9,25	2	18,50
219	875	14	8,75	12	105,00
220	850	14	8,50	2	17,00
221	850	14	8,10	2	16,20
222	805	14	8,05	8	64,40
223	795	14	7,95	16	127,20
224	700	14	7,20	4	28,80
225	620	8	6,20	8	49,60
226	595	14	5,95	6	35,70
227	485	14	4,85	12	58,20
228	460	14	4,60	8	36,80
229	450	14	4,50	2	9,00
230	390	14	3,90	8	31,20
231	315	14	3,70	16	59,20
232	365	14	3,65	2	7,30
233	300	14	3,40	4	13,60
234	330	14	3,30	8	26,40
235	300	14	3,00	99	297,00
236	240	14	2,95	4	11,80
237	255	14	2,90	6	17,40
238	290	14	2,90	6	17,40
239	190	14	2,80	4	11,20
240	220	14	2,75	16	44,00
241	210	14	2,10	8	16,80
242	200	14	2,00	8	16,00
243	195	14	1,95	32	62,40
244	109	14	1,95	31	60,45
245	150	14	1,90	8	15,20
246	84	14	1,80	10	18,00
247	84	14	1,80	4	7,20
248	84	14	1,75	18	31,50
249	84	14	1,75	9	15,75
250	84	14	1,70	9	15,30
251	100	14	1,70	16	27,20

252	125	14	1,65	8	13,20
253	165	14	1,65	4	6,60
254	74	14	1,65	14	23,10
255	76	14	1,60	4	6,40
256	74	14	1,60	18	28,80
257	75	14	1,60	17	27,20
258	80	14	1,50	9	13,50
259	69	12	1,50	80	120,00
260	650	10	6,50	46	299,00
261	290	10	2,00	304	608,00
262	58	10	1,75	114	199,50
263	105	10	1,75	14	28,00
264	69	10	1,50	208	312,00
265	87	10	1,40	32	44,80
266	54	10	1,20	30	36,00
267	55	10	1,20	432	518,40
268	55	8	12,00	12	144,00
269	890	8	8,90	6	53,40
270	670	8	6,70	56	643,20
271	650	8	6,50	46	299,00
272	285	8	2,85	32	91,20
273	215	8	2,15	51	109,65
274	58	8	1,80	28	50,40
275	114	8	1,80	6	10,80
276	65	8	1,72	208	357,76
277	65	8	1,50	100	150,00
278	84	8	1,50	72	108,00
279	63	8	1,40	116	162,40
280	58	8	1,30	450	585,00
281	59	8	1,30	567	729,30
282	48	8	1,34	6	8,04
283	42	8	1,22	49	59,78
284	40	8	1,22	12	14,64
285	100	8	1,00	447	447,00
286	45	8	1,00	6	6,00
287	25	8	0,95	830	788,50
288	25	8	0,91	80	72,80
289	25	8	0,85	24	20,40

JAHAČI - 2 KOM / m²
PLOČA d=22 cm

JAHAČI - 2 KOM / m²
PLOČA d=20 cm

JAHAČI - 2 KOM / m²
PLOČA d=16 cm

NAPOMENA
 Šipke prilagoditi i po potrebi rezi na licu mjesta. Preklop 50Z.

NAPOMENA
 Sve dimenzije provjeriti prema važećim planovima optate.

Klasa betona	C 25/30		
Armatura	B 500 B		
Zaštiti sloj betona			
dijel	gore	bočno	Pripadajući sloj armature:
4,0 cm	4,0 cm	4,0 cm	ARM_E-1.602-604
Pripadajući armaturni nacrti			
ARM_E-1.602-604			

KONSTRUKTA PEČAT I POTPIS:
KONSTRUKTA d.o.o. za projektiranje i nadzor
 Desinićka 20, ZAGREB, OIB: 06674376579
 ZR: PRIVREDNA BANKA 2340009-1110164468
 TEL: 0136 43 826; FAX: 0136 43 829
 MAIL: info@konstrukt.hr

INVESTITOR: TERME TUHELJI d.o.o. Ujvedina Gata 4, Tuhejske Toplice, 49275 Tuhej

LOKACIJA: na k.č.br. 3199/1, k.o. Črešnjevec

FAZA: IZVEDBENI PROJEKT - ARMATURNI NACRTI

SADRŽAJ: ELEMENT - SMJEŠTAINI PAVILION ARMATURA STR. PLOČE SUTERENA GORNJA ZONA

GL. PROJEKTANT: Tomislav Vrdel, dipl. ing. arh.

PROJEKT. IZV. PR: Antonio Maglov, dipl. ing. grad.

IZRADIO: Antonio Maglov, dipl. ing. grad.

DATUM: svibanj 2023.

MJERILO: 1:50

REVIZUAL: 00

NACRT BR: ARM - E-1 - 603

STROPNA PLOČA SUTERENA SMJEŠTAJNOG PAVILIONA
 NACRT SAVIJANJA RUBNE ARMATURE I ANKERA
 M 1:50

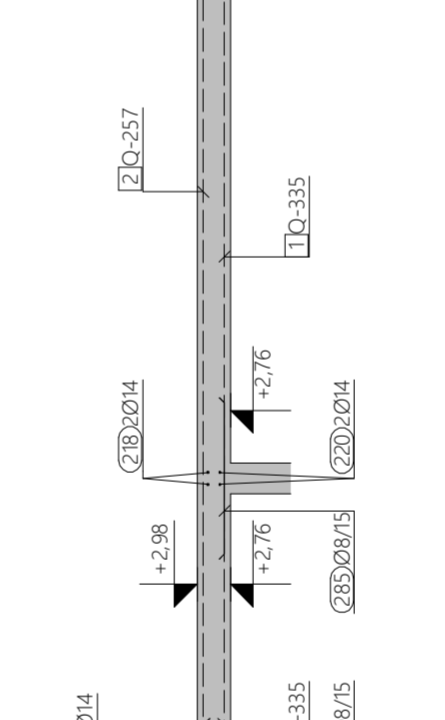
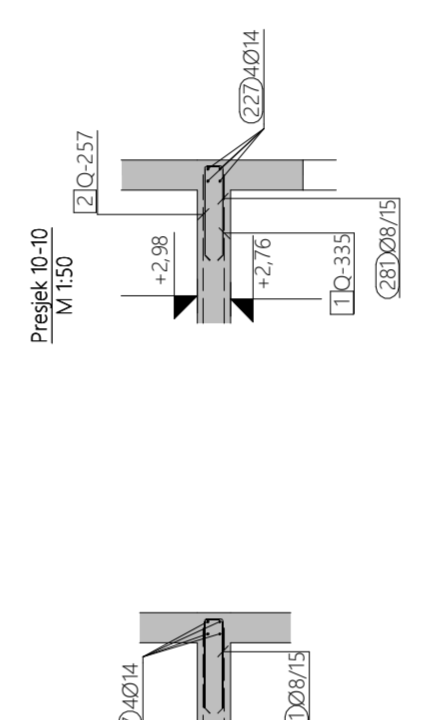
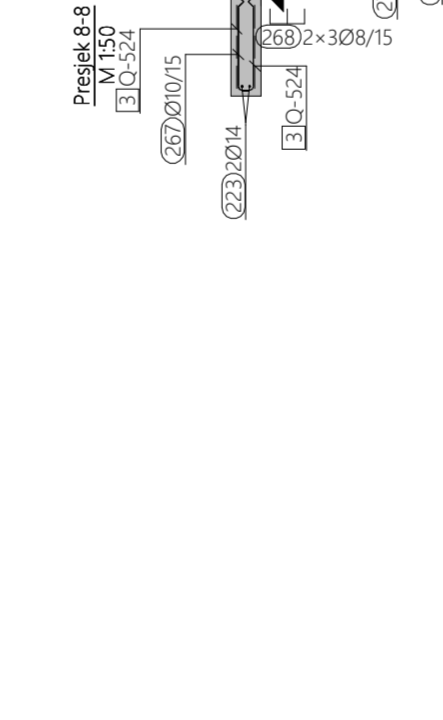
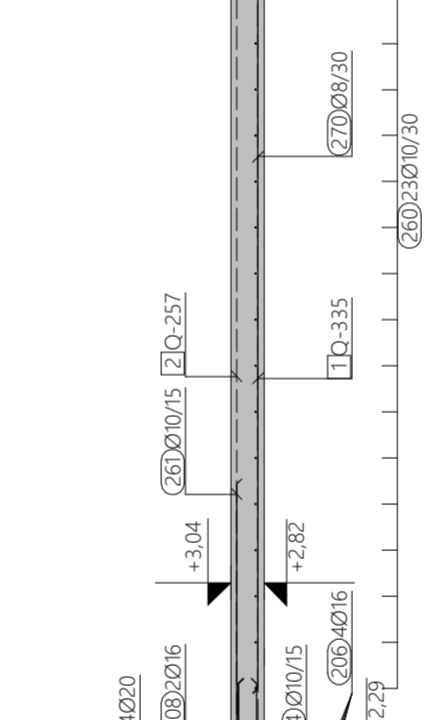
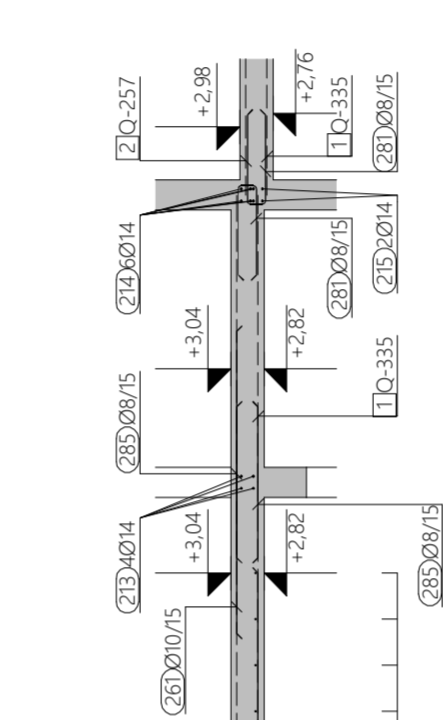
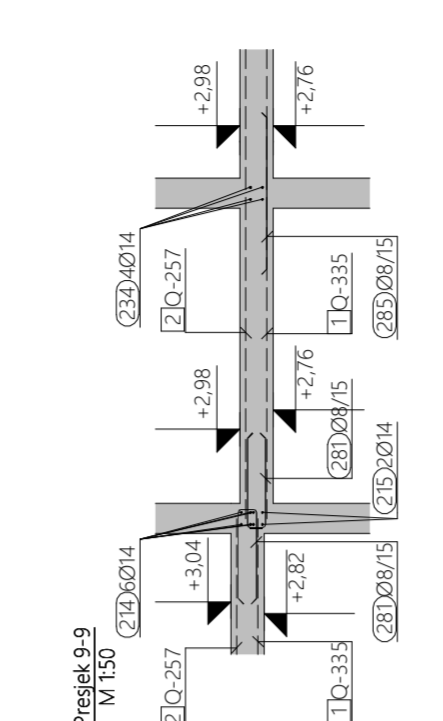
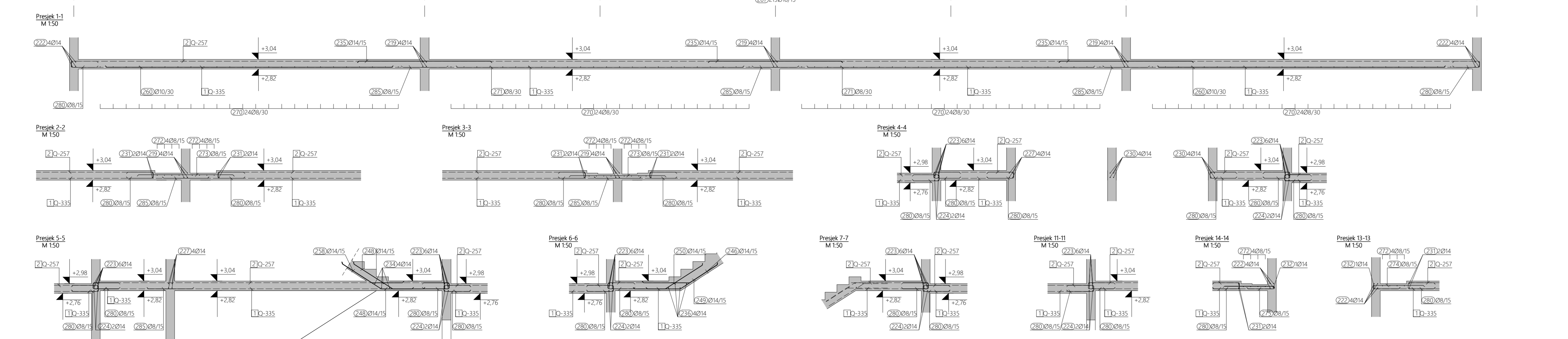
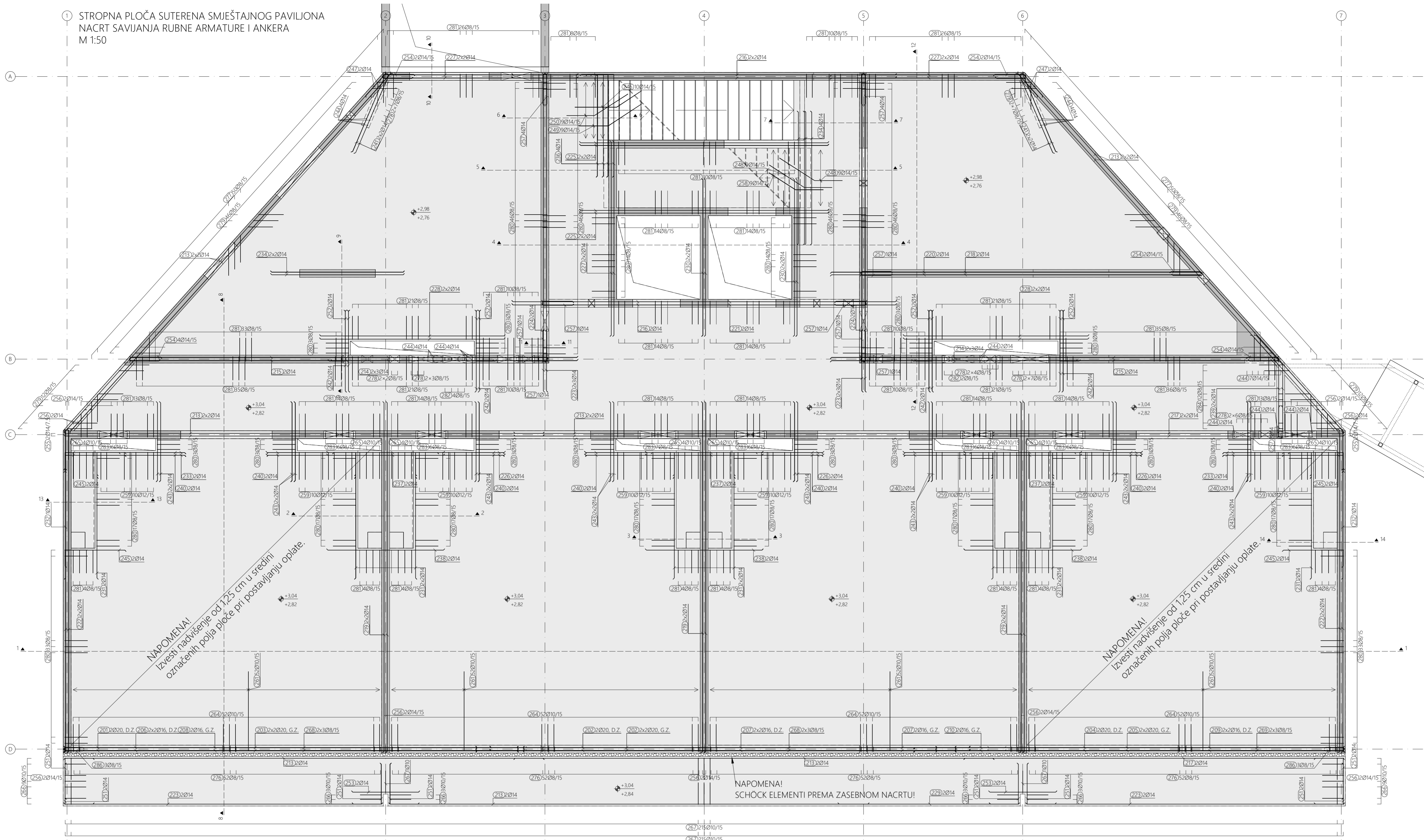

Šipke - specifikacija		Ø	lg	n	lgn
oblik i mjere (mm)	Armatura stropne ploče suterena (1 kom)	(mm)	(mm)	(kom)	(m)
20	105	20	1200	2	2400
200	105	20	1200	6	7200
203	1005	20	1200	4	4800
204	100	20	1140	2	2280
205	1075	20	1140	4	4560
206	150	16	1200	4	4800
207	80	16	1200	6	7200
208	1052	16	1200	2	2400
209	102	16	1070	4	4280
210	100	16	1070	2	2140
211	150	16	350	48	9600
212	100	14	1200	22	26400
214	100	14	1120	12	13440
215	1045	14	1045	4	4180
216	160	14	960	6	5760
217	150	14	950	6	5700
218	125	14	925	2	1850
219	875	14	875	12	10500
220	850	14	850	2	1700
221	880	14	810	2	1620
222	805	14	805	8	6440
223	795	14	795	16	12720
224	700	14	720	4	2880
225	620	14	620	8	4960
226	595	14	595	6	3570
227	485	14	485	12	5820
228	460	14	460	8	3680
229	450	14	450	2	900
230	390	14	390	8	3120
231	315	14	370	16	5920
232	365	14	365	2	730
233	300	14	340	4	1360
234	330	14	330	8	2640
235	300	14	300	99	29700
236	255	14	295	4	1180
237	290	14	290	6	1740
238	290	14	290	6	1740
239	190	14	280	4	1120
240	220	14	275	16	4400
241	210	14	210	8	1680
242	200	14	200	8	1600
243	195	14	195	32	6240
244	129	14	195	31	6045
245	150	14	190	8	1520
246	165	14	180	10	1800
247	84	14	180	4	720
248	84	14	175	18	3150
249	81	14	175	9	1575
250	81	14	170	9	1530
251	100	14	170	16	2720

252	125	14	165	8	1320
253	165	14	165	4	660
254	74	14	165	14	2310
255	76	14	160	4	640
256	74	14	160	18	2880
257	75	14	160	17	2720
258	80	14	150	9	1350
259	69	12	150	80	12000
260	650	10	650	46	29900
261	290	10	200	304	60800
262	58	10	175	114	19950
263	105	10	175	14	2800
264	69	10	150	208	31200
265	67	10	140	32	4480
266	67	10	120	30	3600
267	54	10	120	432	51840
268	55	8	1200	12	14400
269	890	8	890	6	5340
270	670	8	670	56	64320
271	650	8	650	46	29900
272	285	8	285	32	9120
273	215	8	215	51	10965
274	58	8	180	28	5040
275	114	8	180	6	1080
276	65	8	172	208	35776
277	65	8	150	100	15000
278	69	8	150	72	10800
279	63	8	140	116	16240
280	58	8	130	450	58500
281	59	8	130	567	72930
282	48	8	134	6	804
283	42	8	122	49	5978
284	40	8	122	12	1464
285	100	8	100	447	44700
286	45	8	100	6	600
287	25	8	95	830	78850
288	25	8	91	80	7280
289	25	8	85	24	2040

JAHAČI - 2 KOM / m²
 PLOČA d=22 cm

JAHAČI - 2 KOM / m²
 PLOČA d=20 cm

JAHAČI - 2 KOM / m²
 PLOČA d=16 cm

NAPOMENA
 Šipke prilagoditi i po potrebi rezati na licu mjesta. Preklop 50Z.

NAPOMENA
 Sve dimenzije provjeriti prema važećim planovima optate.

Klasa betona	C 25/30
Armatura	B 500 B
Zaštiti sloj betona	
dijelje	gore bočno
4,0 cm	4,0 cm 4,0 cm
Pripadajući isos armature: ARM_E-1.602-604_ISKAZ	
Pripadajući armaturni nacrti	
ARM_E-1.602-603	

KONSTRUKTA PEČAT I POTPIS:

KONSTRUKTA d.o.o., za projektiranje i nadzor
 Desinićka 20, ZAGREB, OIB: 06674376579
 ZR: PRIVREDNA BANKA 2340009-1110164468
 TEL: 0136 43 826; FAX: 0136 43 829
 MAIL: info@konstrukt.hr

INVESTITOR: TERME TUHUELJE d.o.o. Uspjevna Gata 4, Tuhejske Toplice, 49275 Tuhej

GRADEVINA: REKONSTRUKCIJA TERMANOG REKREACIJSKOG CENTRA TERME TUHUELJE

LOKACIJA: na k.č.br. 3199/1, k.o. Črešnjevec

FAZA: IZVEDBENI PROJEKT - ARMATURNI NACRTI

SADRŽAJ: ELEMENT - SMJEŠTAINI PAVILION ARMATURA STR. PLOČE SUTERENA RUBNA ARMATURA I ANKERI

GL. PROJEKTANT: Tomislav Vrh, dipl. ing. arh.

PROJEKT. IZV. PR: Antonio Maglov, dipl. ing. grad.

IZRADIO: Antonio Maglov, dipl. ing. grad.

DATUM: svibanj 2023.

MJERILO: 1:50

REVIZUAL: 00

NACRT BR: ARM - E-1 - 604

ISKAZ ARMATURE	
GRAĐEVINA:	REKONSTRUKCIJA TERMALNOG REKREACIJSKOG CENTRA TERME TUHELJ
ISKAZ UZ NACRT:	ARM_E-1_602-604
SADRŽAJ:	ARMATURA STROPNE PLOČE SUTERENA
DATUM:	svibanj, 2023.

1/9

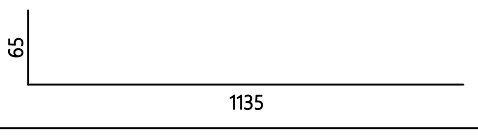
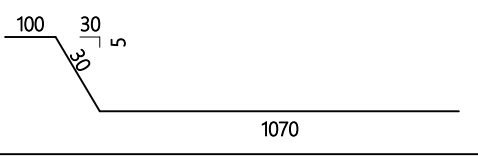
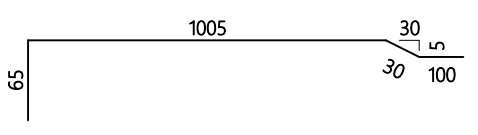
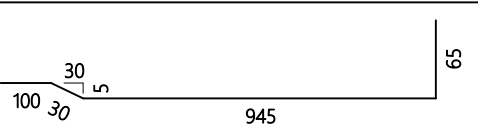
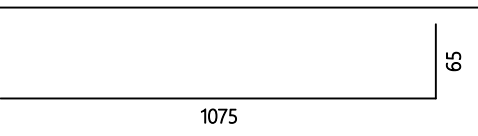
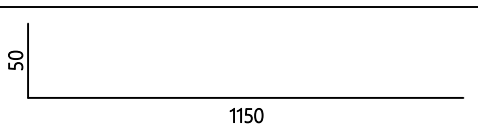
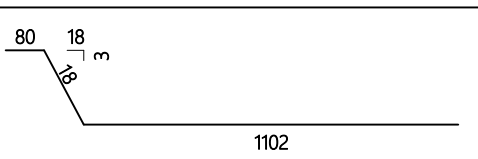
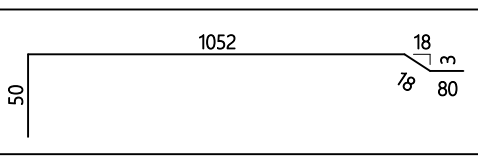
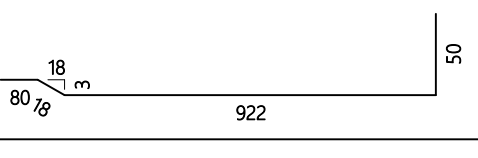
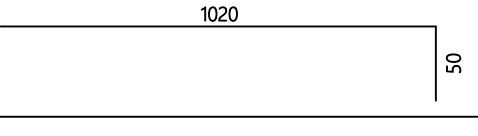
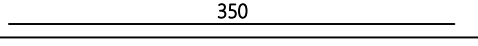
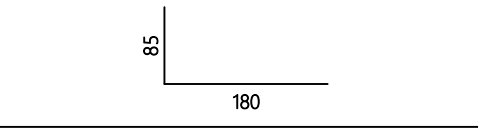
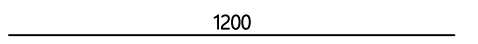
Šipke - specifikacija						
ozn	oblik i mjere [cm]	Ø	lg [m]	n [kom]	lgn [m]	Napomena
Armatura stropne ploče suterena (1 kom)						
201		20	12.00	2	24.00	
202		20	12.00	6	72.00	
203		20	12.00	4	48.00	
204		20	11.40	2	22.80	
205		20	11.40	4	45.60	
206		16	12.00	4	48.00	
207		16	12.00	6	72.00	
208		16	12.00	2	24.00	
209		16	10.70	4	42.80	
210		16	10.70	2	21.40	
211		16	3.50	48	168.00	
212		16	2.65	32	84.80	
213		14	12.00	22	264.00	

ISKAZ ARMATURE		
GRAĐEVINA:	REKONSTRUKCIJA TERMALNOG REKREACIJSKOG CENTRA TERME TUHELJ	
ISKAZ UZ NACRT:	ARM_E-1_602-604	
SADRŽAJ:	ARMATURA STROPNE PLOČE SUTERENA	
DATUM:	svibanj, 2023.	2/9

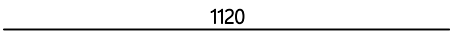
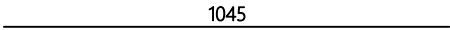
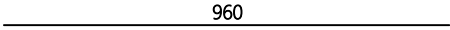
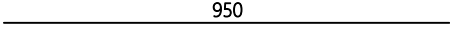
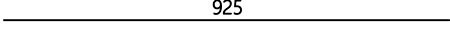
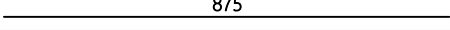
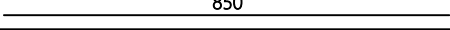
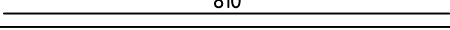
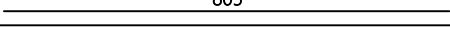
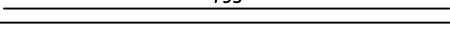
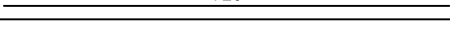
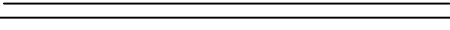
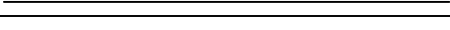
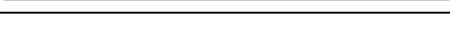
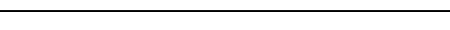
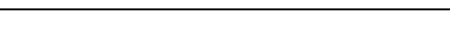
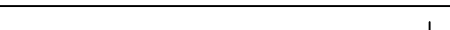
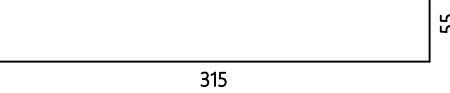
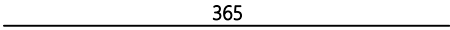
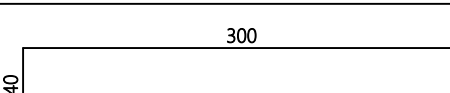
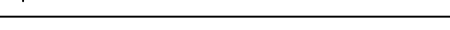
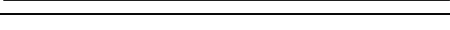
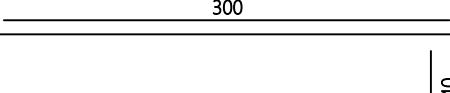
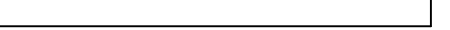
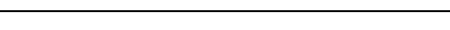
Šipke - specifikacija						
ozn	oblik i mjere [cm]	Ø	lg [m]	n [kom]	lgn [m]	Napomena
214		14	11.20	12	134.40	
215		14	10.45	4	41.80	
216		14	9.60	6	57.60	
217		14	9.50	6	57.00	
218		14	9.25	2	18.50	
219		14	8.75	12	105.00	
220		14	8.50	2	17.00	
221		14	8.10	2	16.20	
222		14	8.05	8	64.40	
223		14	7.95	16	127.20	
224		14	7.20	4	28.80	
225		14	6.20	8	49.60	
226		14	5.95	6	35.70	
227		14	4.85	12	58.20	
228		14	4.60	8	36.80	
229		14	4.50	2	9.00	
230		14	3.90	8	31.20	
231		14	3.70	16	59.20	
232		14	3.65	2	7.30	
233		14	3.40	4	13.60	
234		14	3.30	8	26.40	
235		14	3.00	99	297.00	
236		14	2.95	4	11.80	
237		14	2.90	6	17.40	
238		14	2.90	6	17.40	

ISKAZ ARMATURE

GRAĐEVINA:	REKONSTRUKCIJA TERMALNOG REKREACIJSKOG CENTRA TERME TUHELJ	
ISKAZ UZ NACRT:	ARM_E-1_602-604	
SADRŽAJ:	ARMATURA STROPNE PLOČE SUTERENA	
DATUM:	svibanj, 2023.	3/9

Šipke - specifikacija						
ozn	oblik i mjere [cm]	Ø	lg [m]	n [kom]	lgn [m]	Napomena
239		14	2.80	4	11.20	
240		14	2.75	16	44.00	
241		14	2.10	8	16.80	
242		14	2.00	8	16.00	
243		14	1.95	32	62.40	
244		14	1.95	31	60.45	
245		14	1.90	8	15.20	
246		14	1.80	10	18.00	
247		14	1.80	4	7.20	
248		14	1.75	18	31.50	
249		14	1.75	9	15.75	
250		14	1.70	9	15.30	
251		14	1.70	16	27.20	
252		14	1.65	8	13.20	
253		14	1.65	4	6.60	



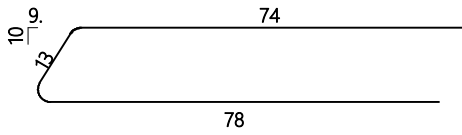
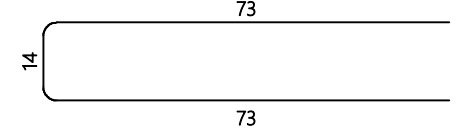
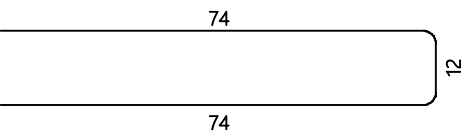
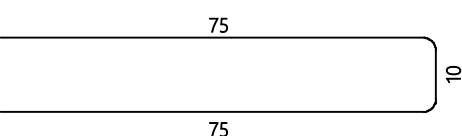
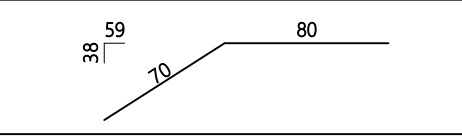
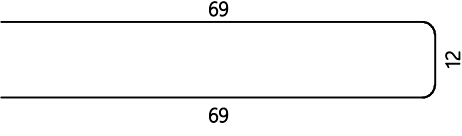
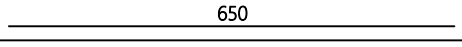
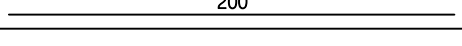
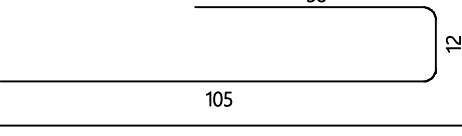
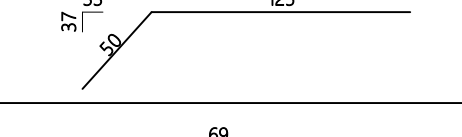
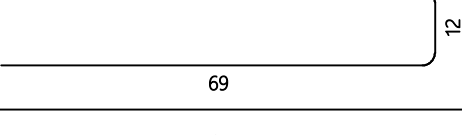
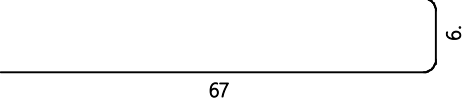

ISKAZ ARMATURE		
GRAĐEVINA:	REKONSTRUKCIJA TERMALNOG REKREACIJSKOG CENTRA TERME TUHELJ	
ISKAZ UZ NACRT:	ARM_E-1_602-604	
SADRŽAJ:	ARMATURA STROPNE PLOČE SUTERENA	
DATUM:	svibanj, 2023.	4/9

Šipke - specifikacija						
ozn	oblik i mjere [cm]	Ø	lg [m]	n [kom]	lgn [m]	Napomena
254		14	1.65	14	23.10	
255		14	1.60	4	6.40	
256		14	1.60	18	28.80	
257		14	1.60	17	27.20	
258		14	1.50	9	13.50	
259		12	1.50	80	120.00	
260		10	6.50	46	299.00	
261		10	2.00	304	608.00	
262		10	1.75	114	199.50	
263		10	1.75	16	28.00	
264		10	1.50	208	312.00	
265		10	1.40	32	44.80	

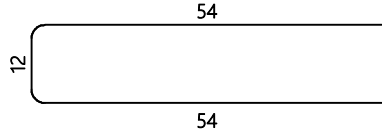
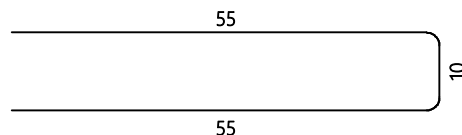
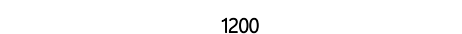
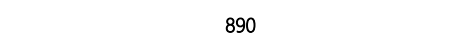
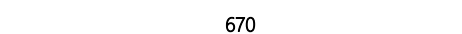

ISKAZ ARMATURE

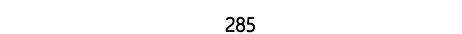
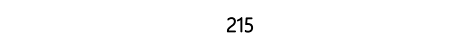
GRAĐEVINA:	REKONSTRUKCIJA TERMALNOG REKREACIJSKOG CENTRA TERME TUHELJ	
ISKAZ UZ NACRT:	ARM_E-1_602-604	
SADRŽAJ:	ARMATURA STROPNE PLOČE SUTERENA	
DATUM:	svibanj, 2023.	5/9

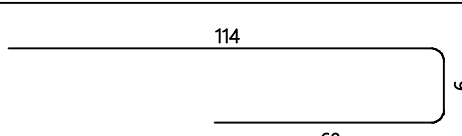
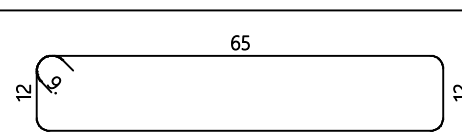
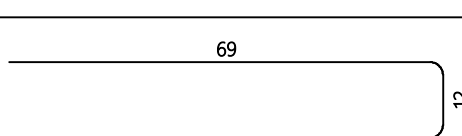
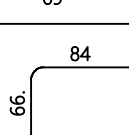
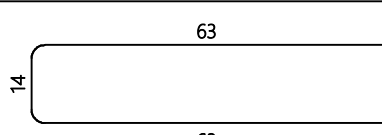
Šipke - specifikacija

ozn	oblik i mjere [cm]	Ø	lg [m]	n [kom]	lgn [m]	Napomena
266		10	1.20	30	36.00	
267		10	1.20	432	518.40	
268		8	12.00	12	144.00	
269		8	8.90	6	53.40	
270		8	6.70	96	643.20	
271		8	6.50	46	299.00	
272		8	2.85	32	91.20	
273		8	2.15	51	109.65	
274		8	1.80	28	50.40	
275		8	1.80	6	10.80	
276		8	1.72	208	357.76	
277		8	1.50	100	150.00	
278		8	1.50	72	108.00	
279		8	1.40	116	162.40	

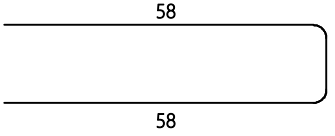
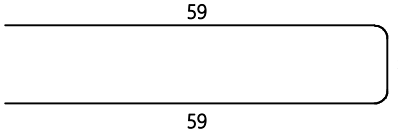
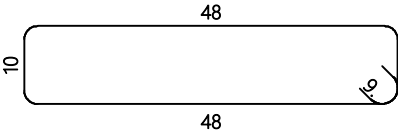
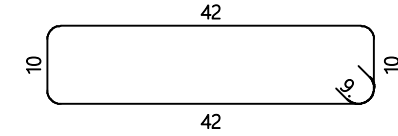
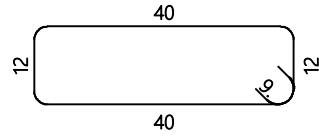
ISKAZ ARMATURE	
GRAĐEVINA:	REKONSTRUKCIJA TERMALNOG REKREACIJSKOG CENTRA TERME TUHELJ
ISKAZ UZ NACRT:	ARM_E-1_602-604
SADRŽAJ:	ARMATURA STROPNE PLOČE SUTERENA
DATUM:	svibanj, 2023. 6/9

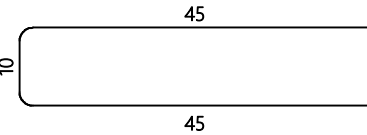
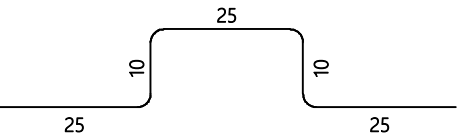
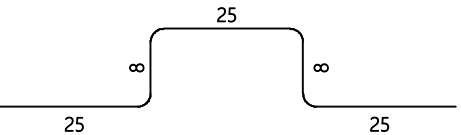
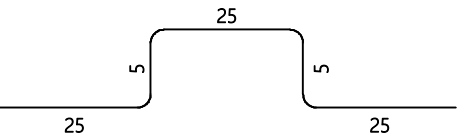
Šipke - specifikacija						
ozn	oblik i mjere [cm]	Ø	lg [m]	n [kom]	lgn [m]	Napomena
280		8	1.30	450	585.00	
281		8	1.30	561	729.30	
282		8	1.34	6	8.04	
283		8	1.22	49	59.78	
284		8	1.22	12	14.64	
285		8	1.00	447	447.00	
286		8	1.00	6	6.00	
287		8	0.95	830	788.50	
288		8	0.91	80	72.80	
289		8	0.85	24	20.40	

ISKAZ ARMATURE		
GRAĐEVINA:	REKONSTRUKCIJA TERMALNOG REKREACIJSKOG CENTRA TERME TUHELJ	
ISKAZ UZ NACRT:	ARM_E-1_602-604	
SADRŽAJ:	ARMATURA STROPNE PLOČE SUTERENA	
DATUM:	svibanj, 2023.	7/9

Šipke - rekapitulacija			
Ø [mm]	lgn [m]	Jedinična težina [kg/m']	Težina [kg]
B500B			
8	4911.27	0.40	1939.95
10	2045.70	0.62	1262.20
12	120.00	0.89	106.56
14	2062.30	1.21	2495.38
16	461.00	1.58	728.38
20	212.40	2.47	524.63
Ukupno (B500B)			7057.10
Ukupno			7057.10

ISKAZ ARMATURE		
GRAĐEVINA:	REKONSTRUKCIJA TERMALNOG REKREACIJSKOG CENTRA TERME TUHELJ	
ISKAZ UZ NACRT:	ARM_E-1_602-604	
SADRŽAJ:	ARMATURA STROPNE PLOČE SUTERENA	
DATUM:	svibanj, 2023.	8/9

Mreže - specifikacija							
Pozicija	Oznaka mreže	B [cm]	L [cm]	n	Jedinična težina [kg/m ²]	Ukupna težina [kg]	Napomena
Armatura stropne ploče suterena (1 kom)							
1	Q-335	215	600	16	5.38	1110.43	
1-1	Q-335	190	300	1	5.38	30.67	
1-2	Q-335	190	600	1	5.38	61.33	
1-3	Q-335	215	592	2	5.38	137.06	
1-4	Q-335	215	330	4	5.38	152.68	
1-5	Q-335	120	330	1	5.38	21.31	
1-6	Q-335	190	441	1	5.38	45.03	
1-7	Q-335	190	300	1	5.38	30.66	
1-8	Q-335	190	600	1	5.38	61.33	
1-9	Q-335	190	283	1	5.38	28.91	
1-10	Q-335	212	190	2	5.38	43.23	
1-11	Q-335	170	515	1	5.38	47.10	
1-12	Q-335	215	480	1	5.38	55.58	
1-13	Q-335	215	600	4	5.38	277.61	
1-14	Q-335	215	342	1	5.38	39.53	
1-15	Q-335	200	600	1	5.38	64.56	
1-16	Q-335	200	480	1	5.38	51.70	
1-17	Q-335	170	570	2	5.38	104.26	
1-18	Q-335	215	245	16	5.38	453.43	
1-19	Q-335	155	288	1	5.38	24.02	
1-20	Q-335	155	600	1	5.38	50.03	
1-22	Q-335	110	600	4	5.38	142.03	
1-23	Q-335	158	176	1	5.38	14.94	
1-26	Q-335	110	245	4	5.38	58.00	
2	Q-257	215	600	7	4.12	372.04	
2-1	Q-257	215	600	16	4.12	850.37	
2-2	Q-257	215	155	4	4.12	54.92	
2-3	Q-257	199	155	2	4.12	25.39	
2-4	Q-257	215	587	2	4.12	104.02	
2-5	Q-257	215	397	2	4.12	70.37	
2-6	Q-257	185	207	2	4.12	31.68	
2-7	Q-257	170	570	3	4.12	119.77	
2-8	Q-257	170	600	1	4.12	42.02	
2-9	Q-257	95	190	1	4.12	7.44	
2-10	Q-257	215	235	11	4.12	228.98	
2-11	Q-257	90	190	1	4.12	7.05	
2-12	Q-257	215	190	2	4.12	33.66	

ISKAZ ARMATURE		
GRAĐEVINA:	REKONSTRUKCIJA TERMALNOG REKREACIJSKOG CENTRA TERME TUHELJ	
ISKAZ UZ NACRT:	ARM_E-1_602-604	
SADRŽAJ:	ARMATURA STROPNE PLOČE SUTERENA	
DATUM:	svibanj, 2023.	9/9

Mreže - specifikacija							
Pozicija	Oznaka mreže	B [cm]	L [cm]	n	Jedinična težina [kg/m ²]	Ukupna težina [kg]	Napomena
2-13	Q-257	210	235	1	4.12	20.33	
2-14	Q-257	195	235	1	4.12	18.88	
2-15	Q-257	75	190	1	4.12	5.87	
2-16	Q-257	185	600	1	4.12	45.73	
2-17	Q-257	110	190	1	4.12	8.61	
2-18	Q-257	190	600	4	4.12	187.87	
2-19	Q-257	168	145	2	4.12	20.10	
2-20	Q-257	215	385	2	4.12	68.21	
2-21	Q-257	215	330	2	4.12	58.46	
2-22	Q-257	120	385	1	4.12	19.03	
3-1	Q-524	115	600	10	8.31	573.39	
3-2	Q-524	115	435	2	8.31	83.14	
Ukupno						6162.75	

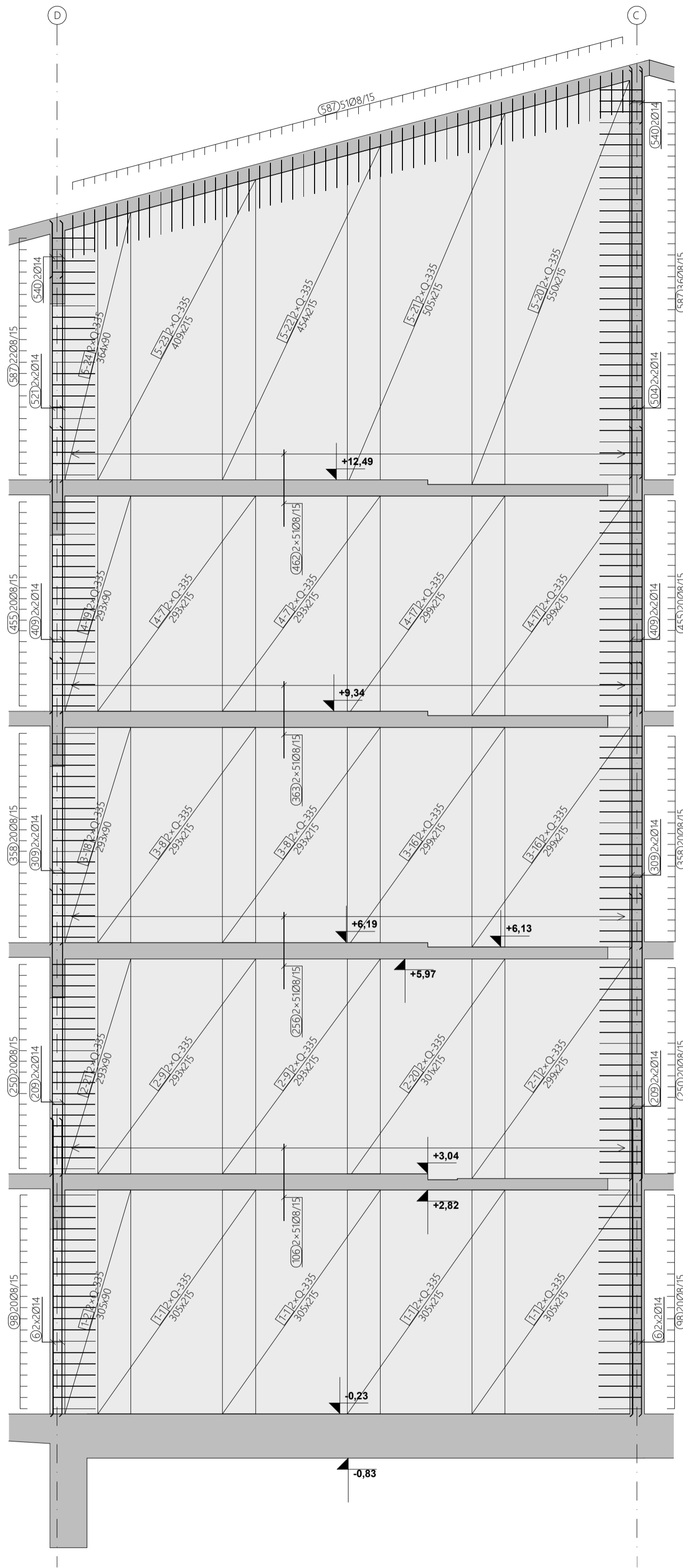
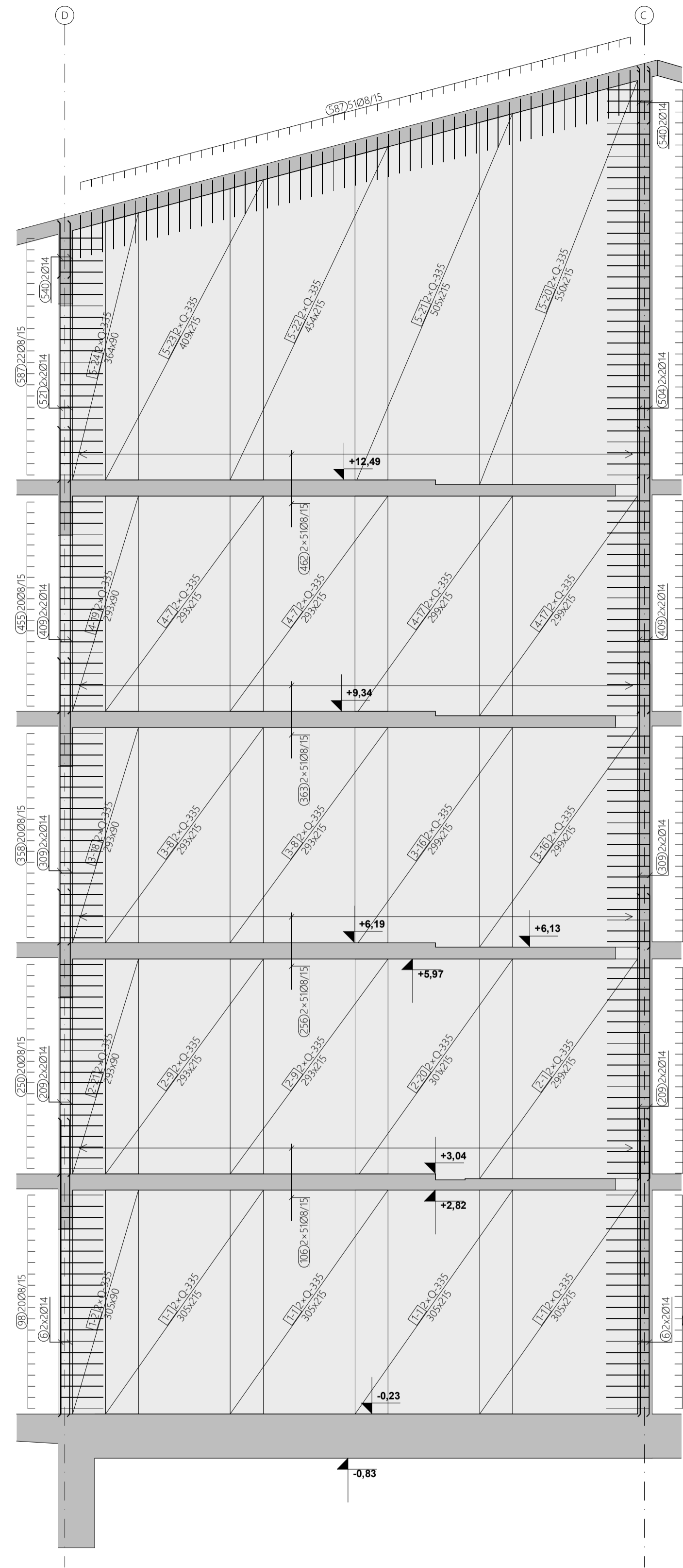
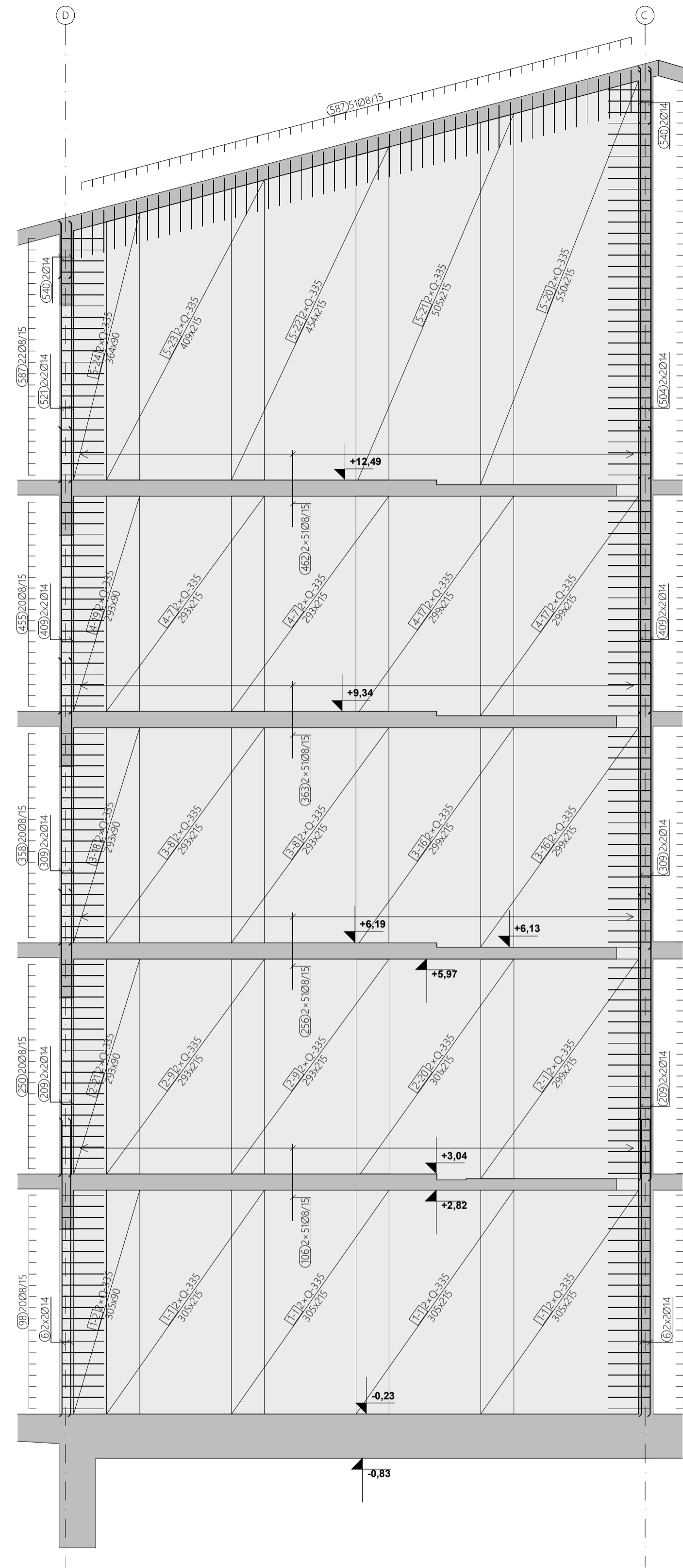
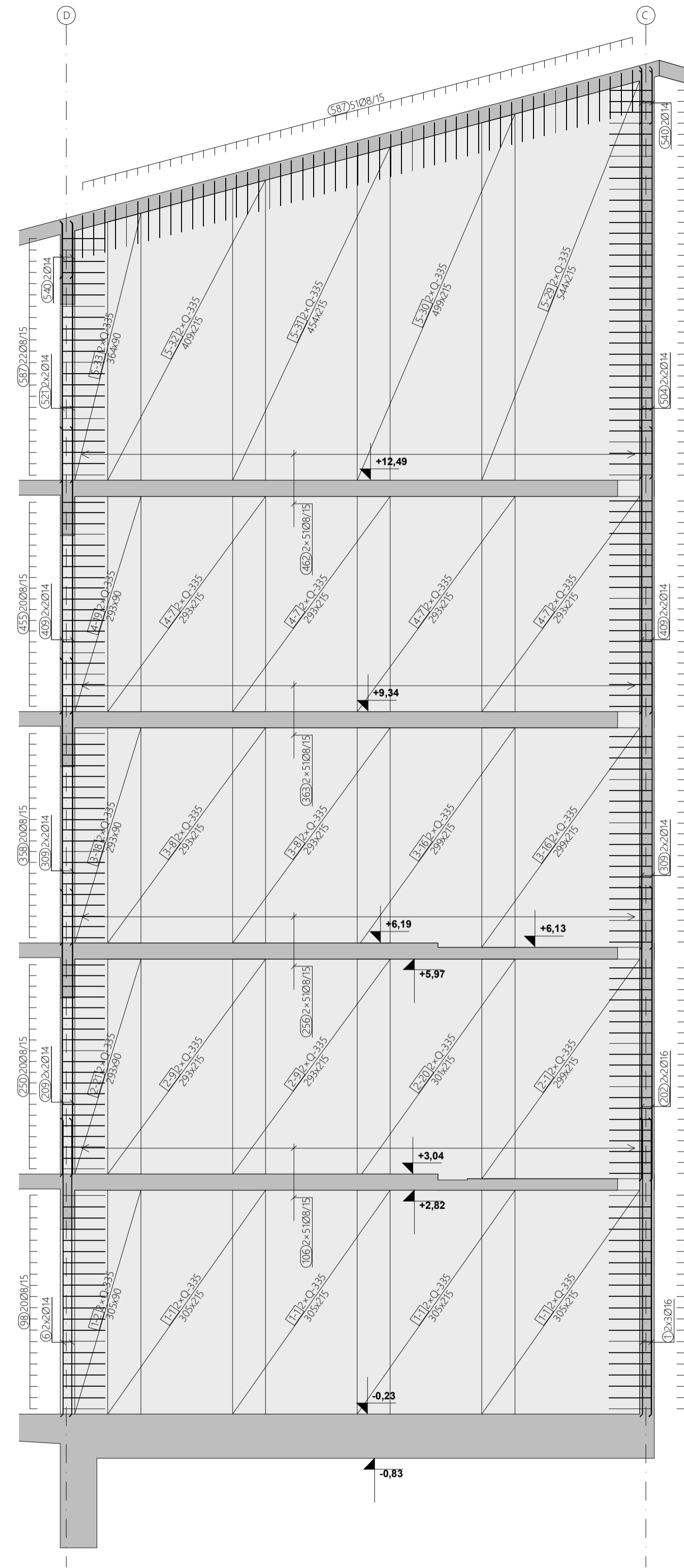

DETALJ POSTAVLJANJA DISTANCERA U ZIDOVE SUTERENA

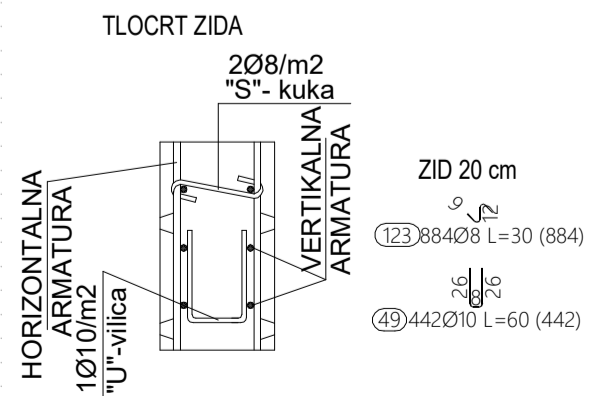

DETALJ POSTAVLJANJA DISTANCERA U ZIDOVE PRIZEMLJA

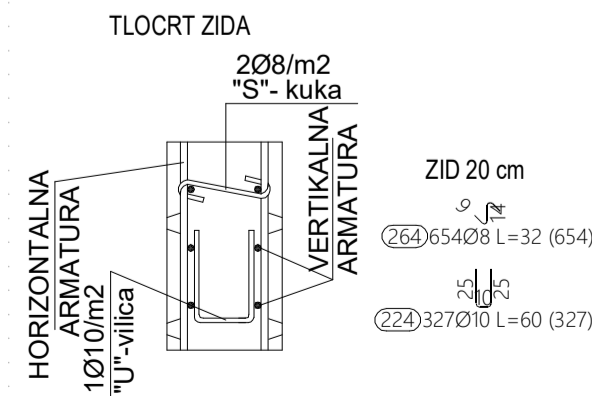

DETALJ POSTAVLJANJA DISTANCERA U ZIDOVE PRVOG KATA

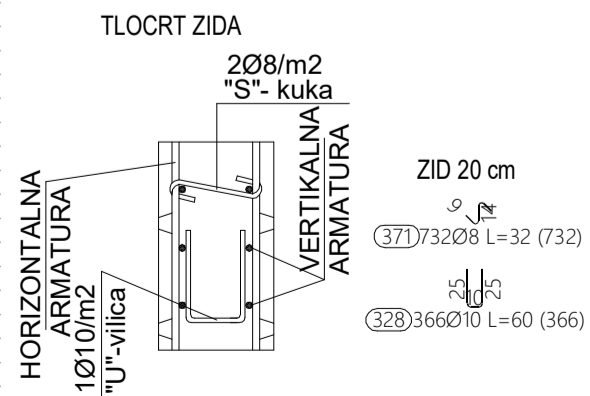

DETALJ POSTAVLJANJA DISTANCERA U ZIDOVE DRUGOG KATA

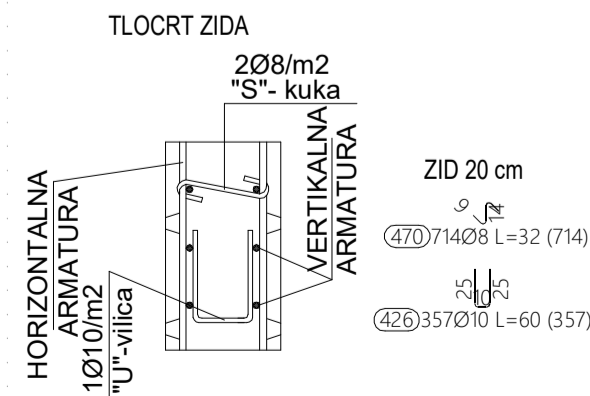

DETALJ POSTAVLJANJA DISTANCERA U ZIDOVE TREĆEG KATA

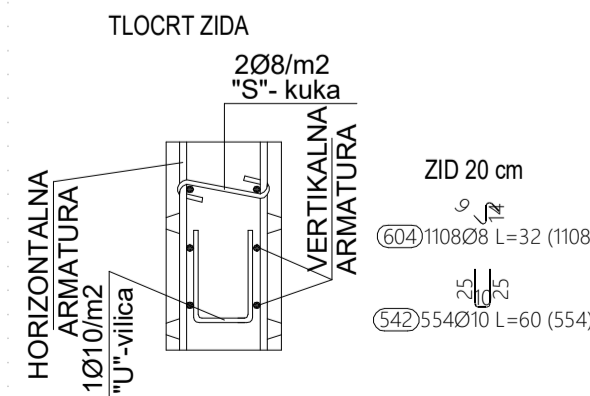

NAPOMENA

Šipke prilagoditi i po potrebi rezati na licu mjesta. Preklap 50Ø.

NAPOMENA

Sve dimenzije provjeriti prema važećim planovima optate.

Klasa betona	C 25/30
Armatura	B 500 B
Zaštitni sloj betona podzemnih zidova	Pripadajuća lista armature : ARM_E-1_605-611_ISKAZ
obostrano	
4,0 cm	
Zaštitni sloj betona nadzemnih zidova	
obostrano	
3,0 cm	
Pripadajući armaturni nacrti	
ARM_E-1_605-611	

KONSTRUKTA

KONSTRUKTA d.o.o., za projektiranje i nadzor
Desinićka 20, ZAGREB, OIB: 06674378579
ZR: PRIVREDNA BANKA 2340009-1110164468
TEL: 01/36 43 828; FAX: 01/36 43 829
MAIL: info@konstrukt.hr

PEČAT I POTPIS:

IZVODAKA KOPIJA IZ OBLASTI GRAĐEVINARSTVA
Antonio Maglov, dipl. ing. grad.
441-361-5116
Dizajnerski i inženjerski građevinarstvo
6 3775

INVESTITOR:	TERME TUHELJ d.o.o. Ljudevita Gaja 4, Tuhelečke Toplice, 49215 Tuhej	GL. PROJEKTANT:	Tomislav Vreš, dipl. ing. arh.
GRAĐEVINA:	REKONSTRUKCIJA TERMALNOG REKREACIJSKOG CENTRA TERME TUHELJ	PROJEKT. IZV. PR:	Antonio Maglov, dipl. ing. grad.
LOKACIJA:	na k.č.br. 3199/1, k.o. Črešnjevec	IZRADIO:	Antonio Maglov, dipl. ing. grad.
FAZA:	IZVEDBENI PROJEKT - ARMATURNI NACRTI	DATUM:	lipanj 2023.
SADRŽAJ:	ELEMENT - SMJEŠTAJNI PAVILJON ARMATURA ZIDOVA 1/7	MJERILO:	1:50
		REVIZIJA:	00
		NACRT BR.:	ARM - E-1 - 605

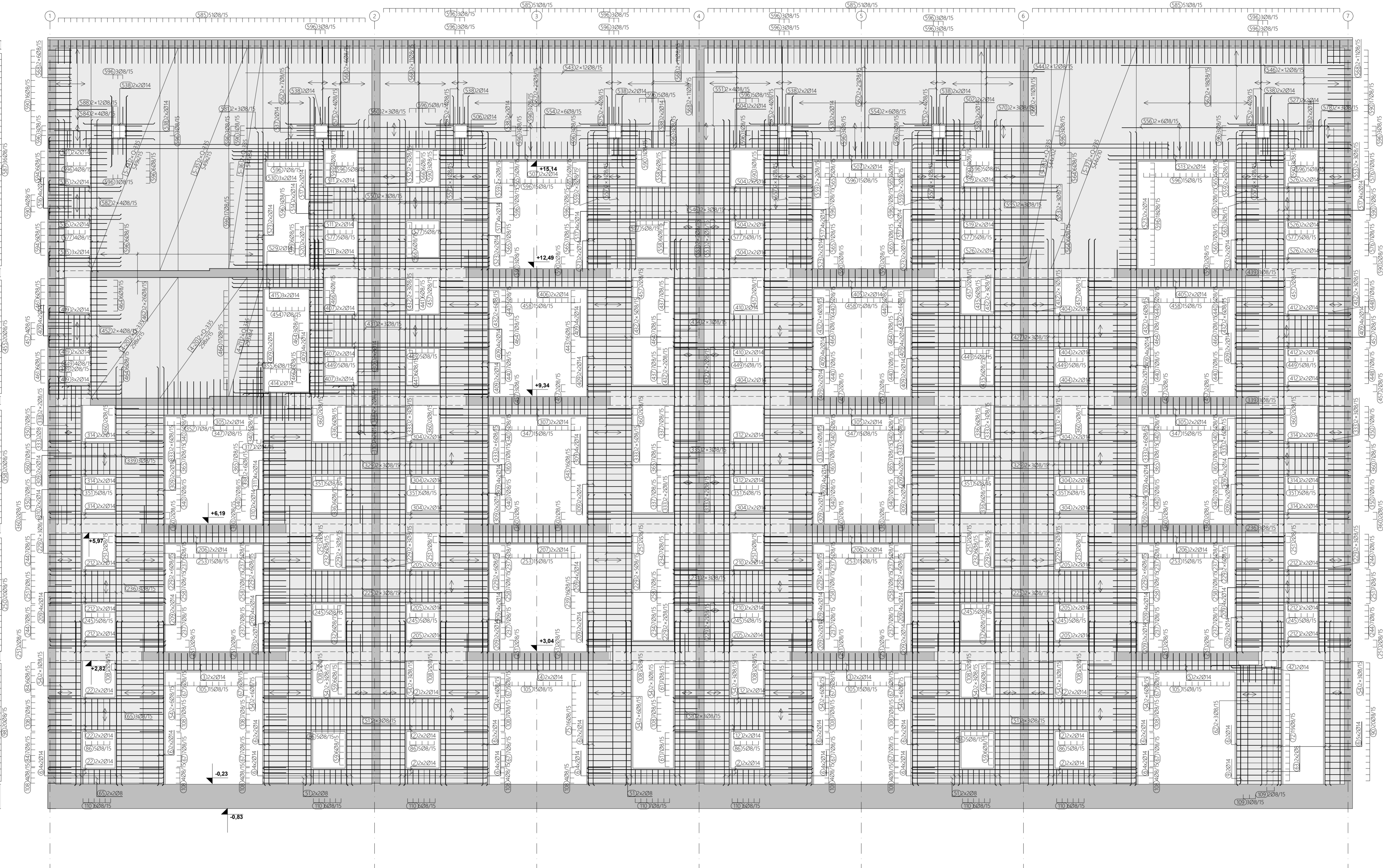
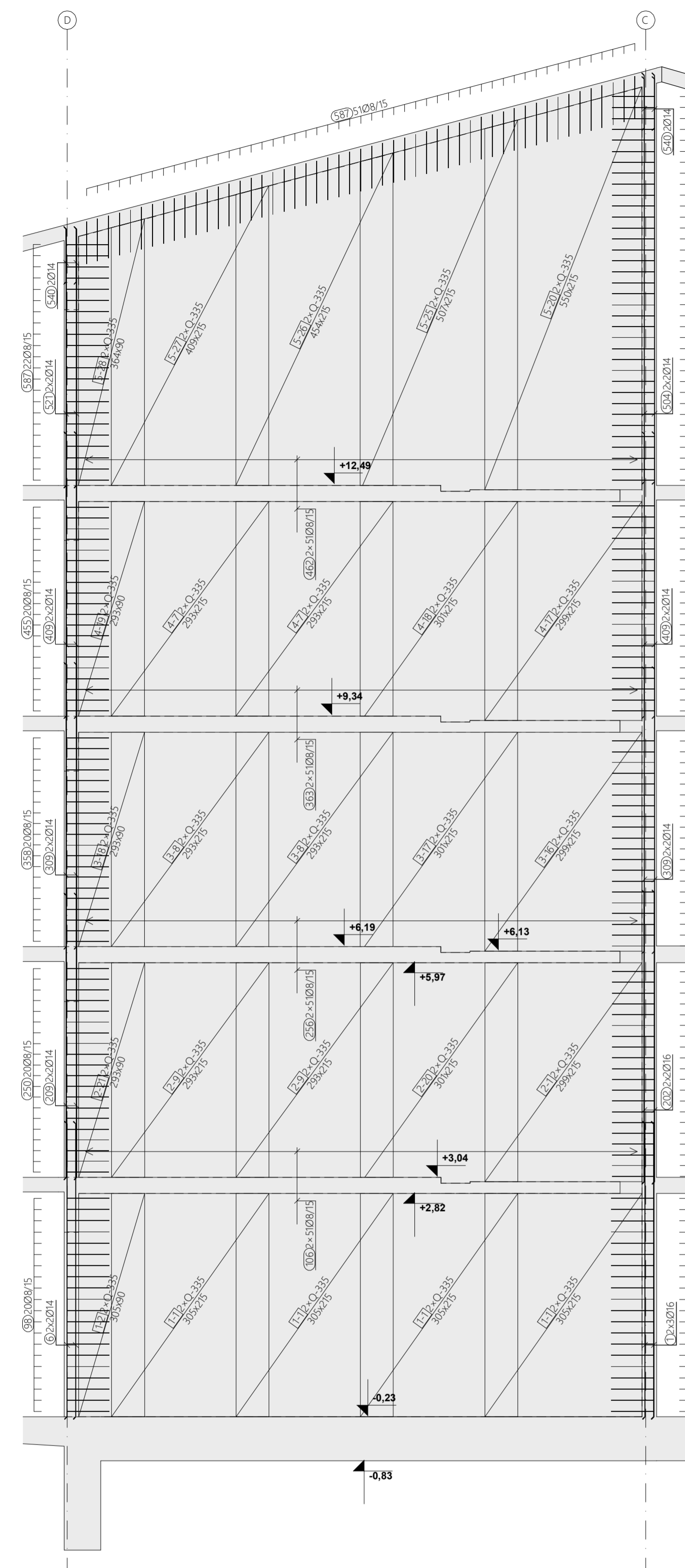

DETALJI POSTAVLJANJA DISTANCERA U ZIDOVE PRIZESTERA

TLOCRT ZIDA

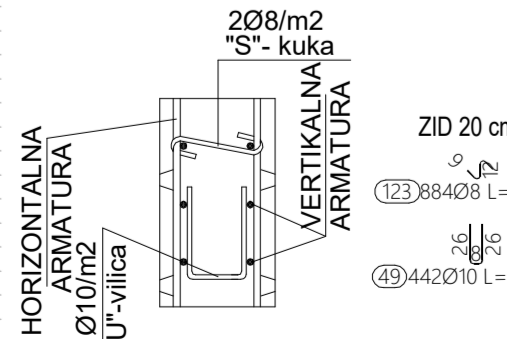

DETALJI POSTAVLJANJA DISTANCERA U ZIDOVE PRIZESTERA

TLOCRT ZIDA

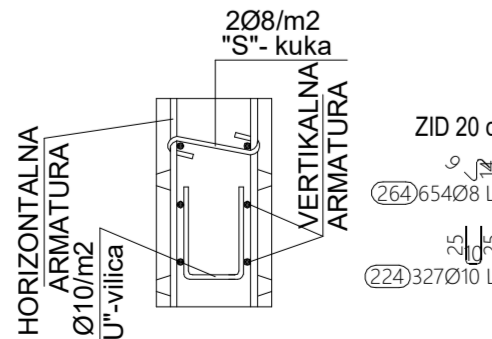

DETALJI POSTAVLJANJA DISTANCERA U ZIDOVE PRVOG KATA

TLOCRT ZIDA

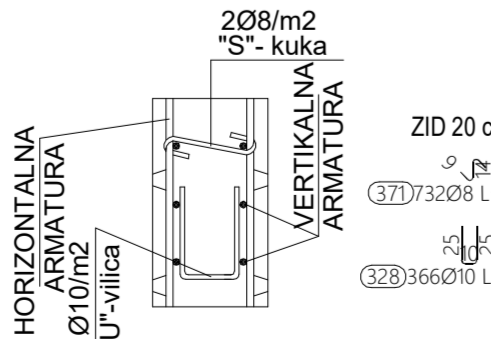

DETALJI POSTAVLJANJA DISTANCERA U ZIDOVE DRUGOG KATA

TLOCRT ZIDA

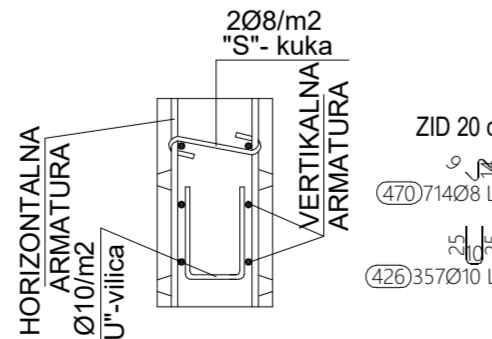

DETALJI POSTAVLJANJA DISTANCERA U ZIDOVE TREĆEG KATA

TLOCRT ZIDA

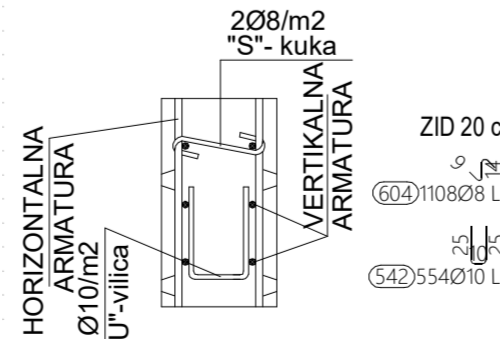

NAPOMENA
Šipke prilagoditi i po potrebi rezati na licu mjesta. Prekok 50Ø.

NAPOMENA
Sve dimenzije provjeriti prema važećim planovima oplote.

Klasa betona	C 25/30
Armatura	B 500 B
Zaštitni sloj betona podzemnih zidova	
obotrano	Pripadajuća lista armature :
4.0 cm	ARM_E-1_605-611_ISKAZ
Zaštitni sloj betona nadzemnih zidova	
obotrano	
3.0 cm	
Pripadajući armaturni nacrti	
	ARM_E-1_605-607-611

KONSTRUKTA KONSTRUKTA d.o.o., za projektiranje i nadzor Desinićka 20, ZAGREB, OIB: 9674378379 Žrt. PRIVREDNA BANKA 2340009-1110164468 TEL: 01/36 43 828; FAX: 01/36 43 829 MAIL: info@konstrukta.hr	PEČATI I POTPIŠI:	 KONSTRUKTA ANTONIJA MAGLOV d.p.l. ing. građ. Ovlašteni inženjer građevinstva 6 3775	
	INVESTITOR:		GL. PROJEKTANT:
	GRADEVINA:		PROJEKT. IZV. PR:
LOKACIJA:	IZRADIO:	Tomislav Vreš, dipl. ing. arh. Antonio Maglov, dipl. ing. građ. Antonio Maglov, dipl. ing. građ.	
FAZA: IZVEDBENI PROJEKT - ARMATURNI NACRTI	DATUM:	lipni 2023.	
SAORZAJ: ELEMENT - SMAJŠTAINI PAVILJON ARMATURA ZIDOVA 27	MJERILO:	1:50 REVIZIJA: 00	
	NACRT BR.:	ARM - E-1 - 606	

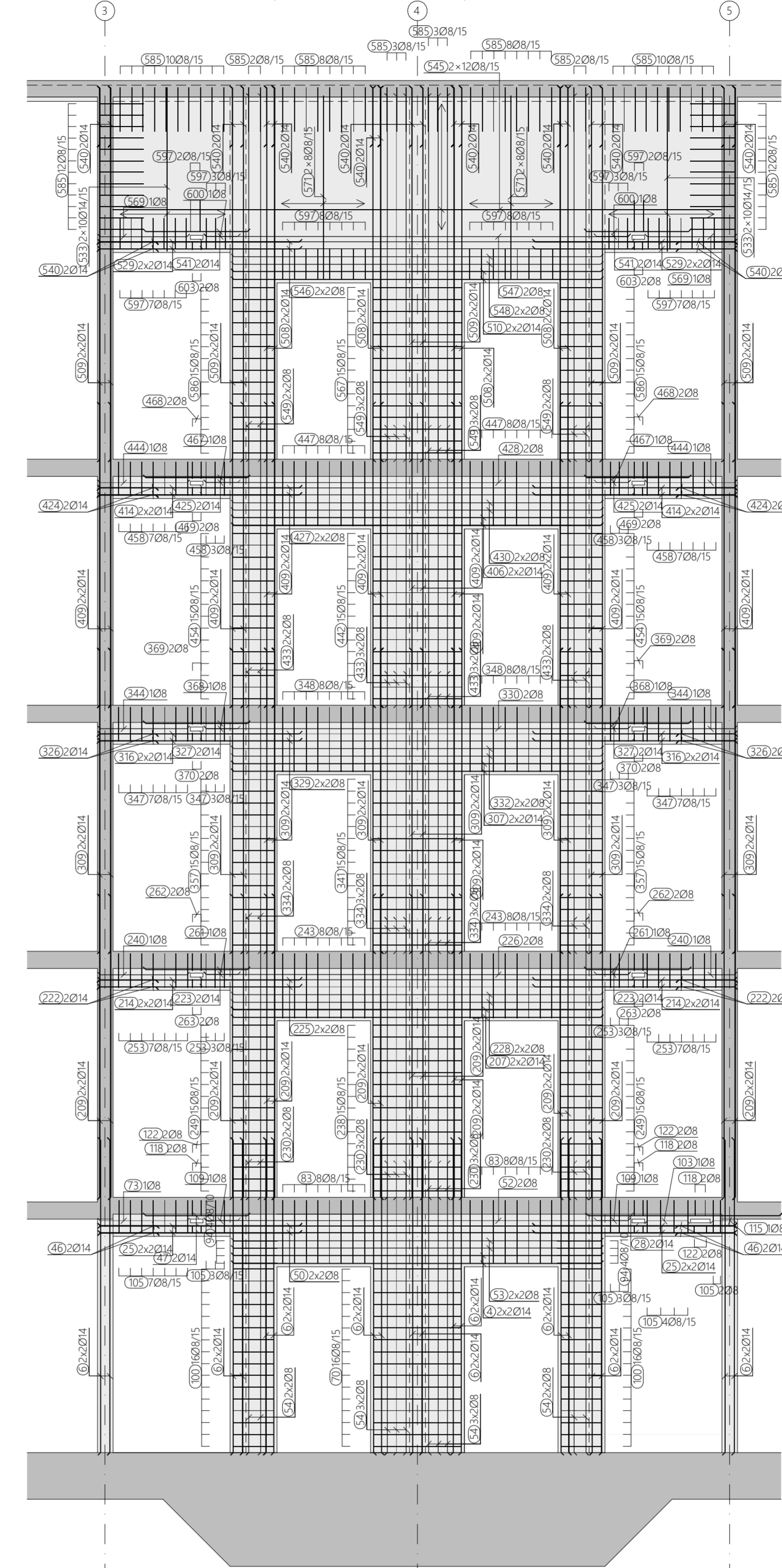
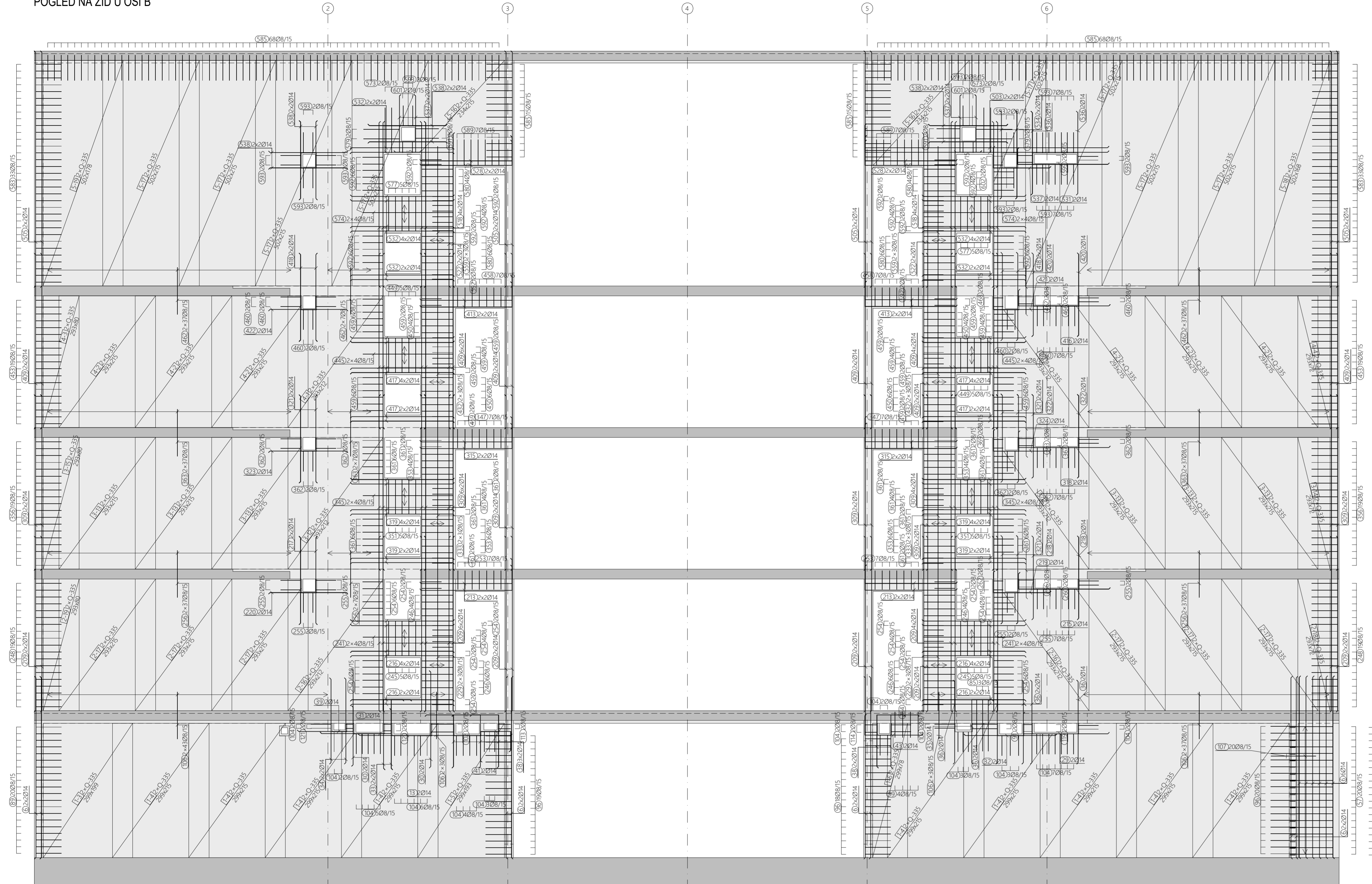

NAPOMENA
Šipke prilagoditi i po potrebi rezati na licu mjesta. Prekop 50Ø.

NAPOMENA
Sve dimenzije provjeriti prema važećim planovima optate.

Klasa betona	C 25/30
Armatura	B 500 B
Zaštitni sloj betona podzemnih zidova	
obostrano	Pripadajuća lista armature :
4.0 cm	ARM_E-1_605-611_ISKAZ
Zaštitni sloj betona nadzemnih zidova	
obostrano	
3.0 cm	
Pripadajući armaturni nacrti	
	ARM_E-1_605.606.608-611

DETALJ POSTAVLJANJA DISTANCERA U ZIDOVE SUTERENA

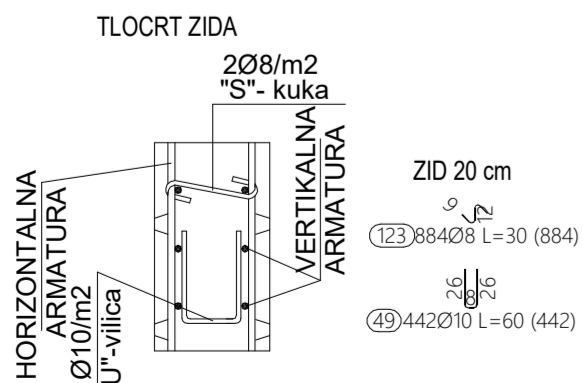

DETALJ POSTAVLJANJA DISTANCERA U ZIDOVE PRIZEMLJA

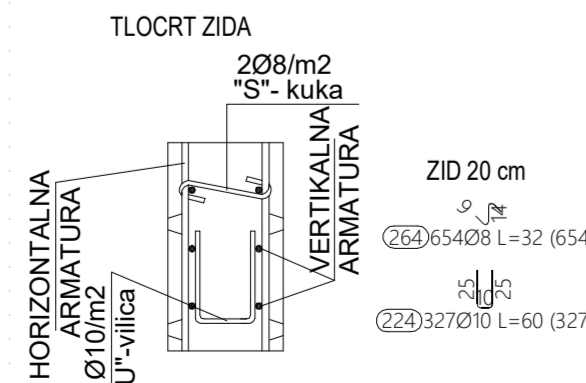

DETALJ POSTAVLJANJA DISTANCERA U ZIDOVE PRVOG KATA

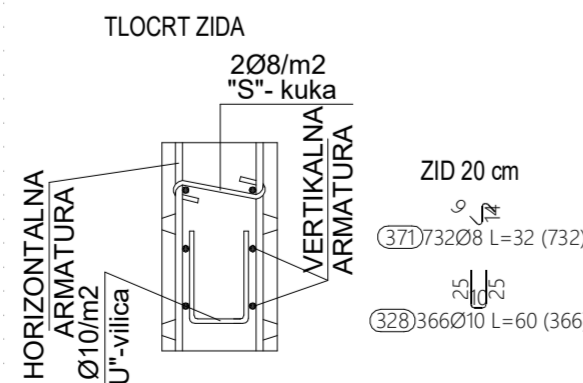

DETALJ POSTAVLJANJA DISTANCERA U ZIDOVE DRUGOG KATA

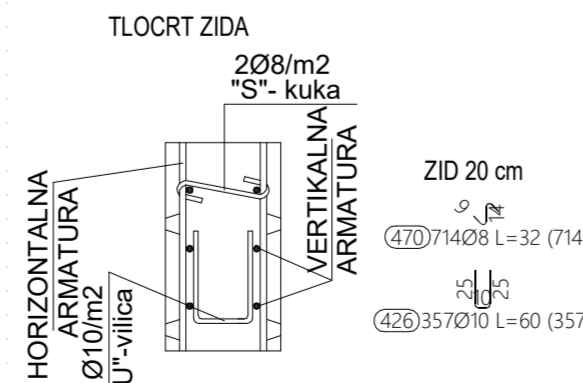

DETALJ POSTAVLJANJA DISTANCERA U ZIDOVE TREĆEG KATA

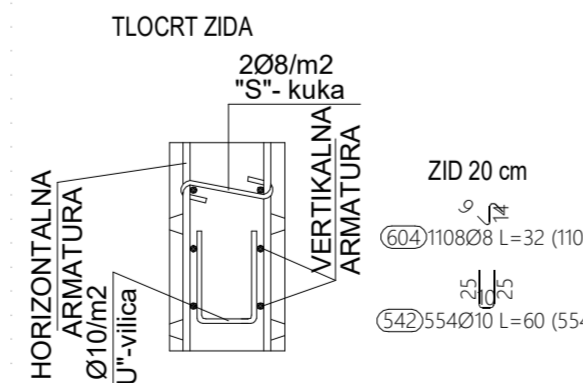

KONSTRUKTA		PEČAT I POTPIS:	
KONSTRUKTA d.o.o., za projektiranje i nadzor Desimčića 20, ZAGREB, OIB: 9674378979 ŽR: PRIVREDNA BANKA 2340009-1110164468 TEL: 01/36 43 828; FAX: 01/36 43 829 MAIL: info@konstrukt.hr			
INVESTITOR:	TERME TUHELJ d.o.o. Ljudevita Gaja 4, Tuhejke Topole, 49215 Tuhej	GL. PROJEKTANT:	Tomislav Vraš, dipl. ing. arh.
GRAĐEVINA:	REKONSTRUKCIJA TERMALNOG REKREACIJSKOG CENTRA TERME TUHELJ	PROJEKT. IZV. PR:	Antonio Maglov, dipl. ing. građ.
LOKACIJA:	na k.č.br. 3199/1, k.o. Črešnjavec	IZRADIO:	Antonio Maglov, dipl. ing. građ.
FAZA:	IZVEDBENI PROJEKT - ARMATURNI NACRTI	DATUM:	lipanj 2023.
SADRŽAJ:	ELEMENT - SMJEŠTAJNI PAVILJON ARMATURA ZIDOVA 37	MJERILO:	1:50
		REVIZIJA:	00
		NACRT BR.:	ARM - E-1 - 607

POGLED NA ZIDOVE IZMEĐU OSI A I B

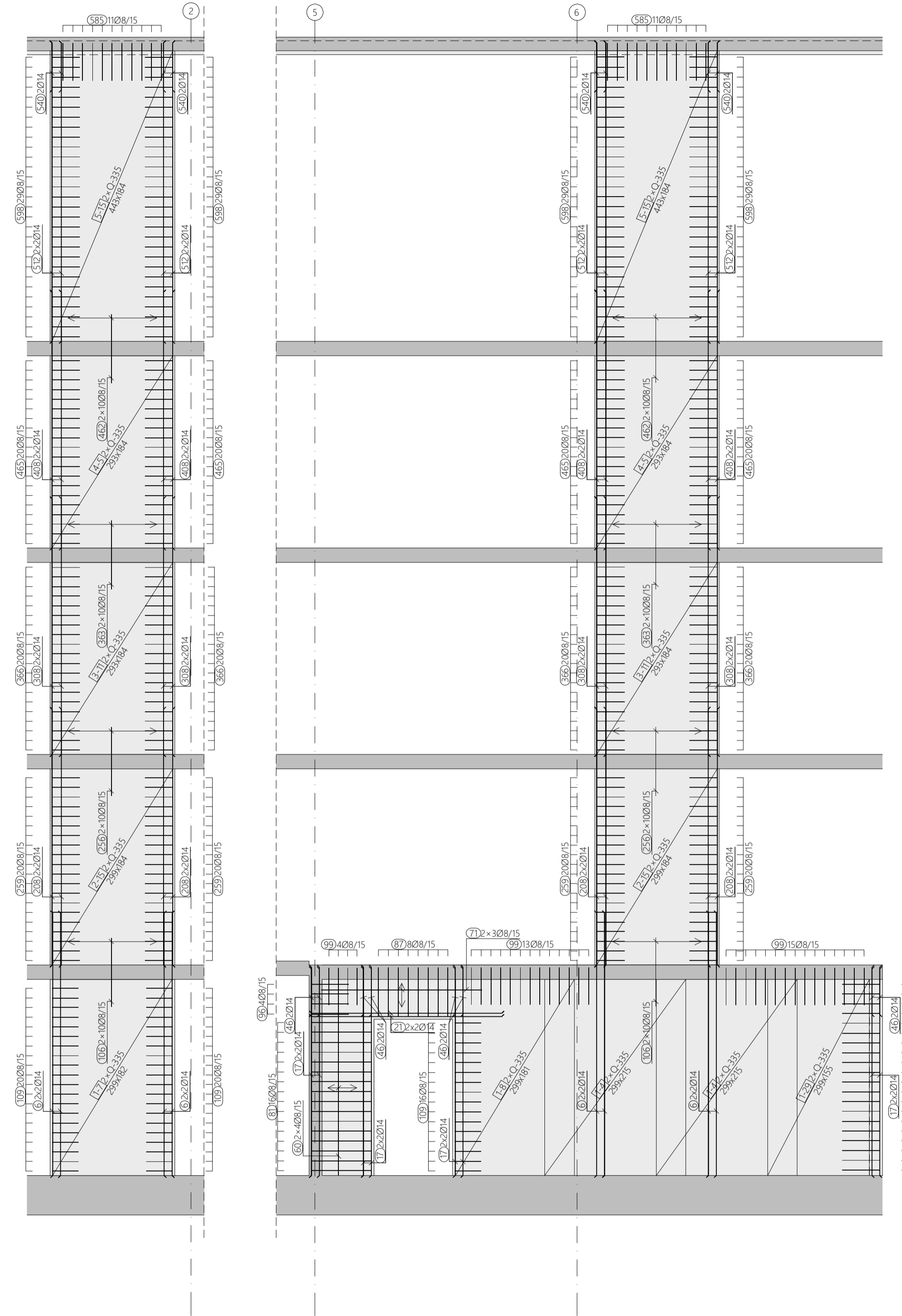

POGLED NA ZID BLIŽE OSI A (KOD OKNA ZA DIZALO)

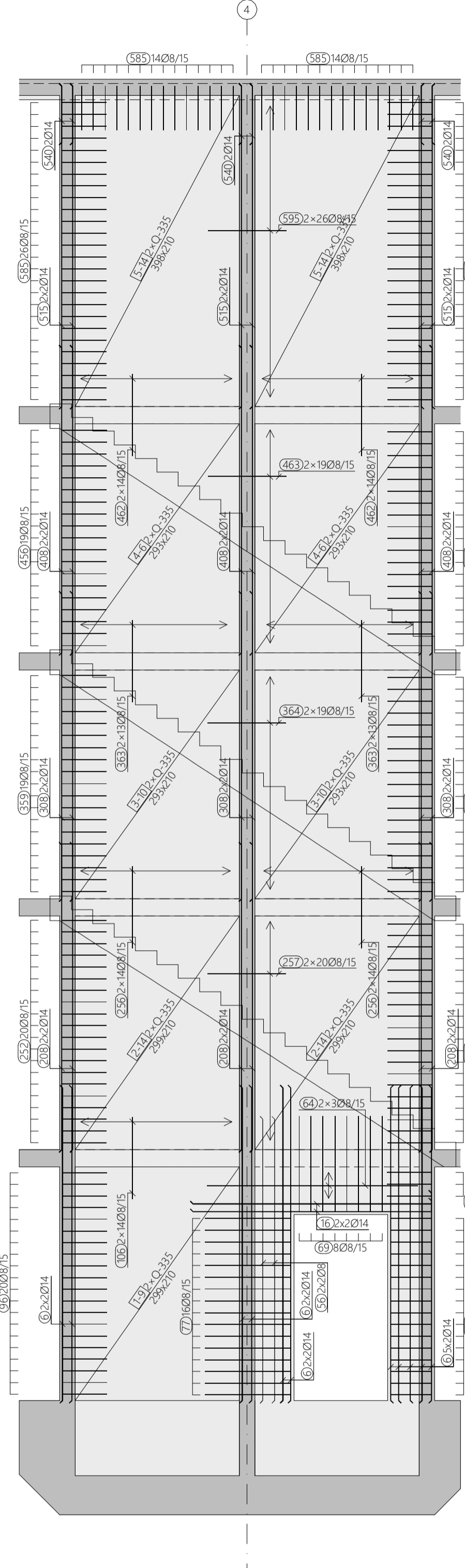

POGLED NA ZID ISPOD OSI A

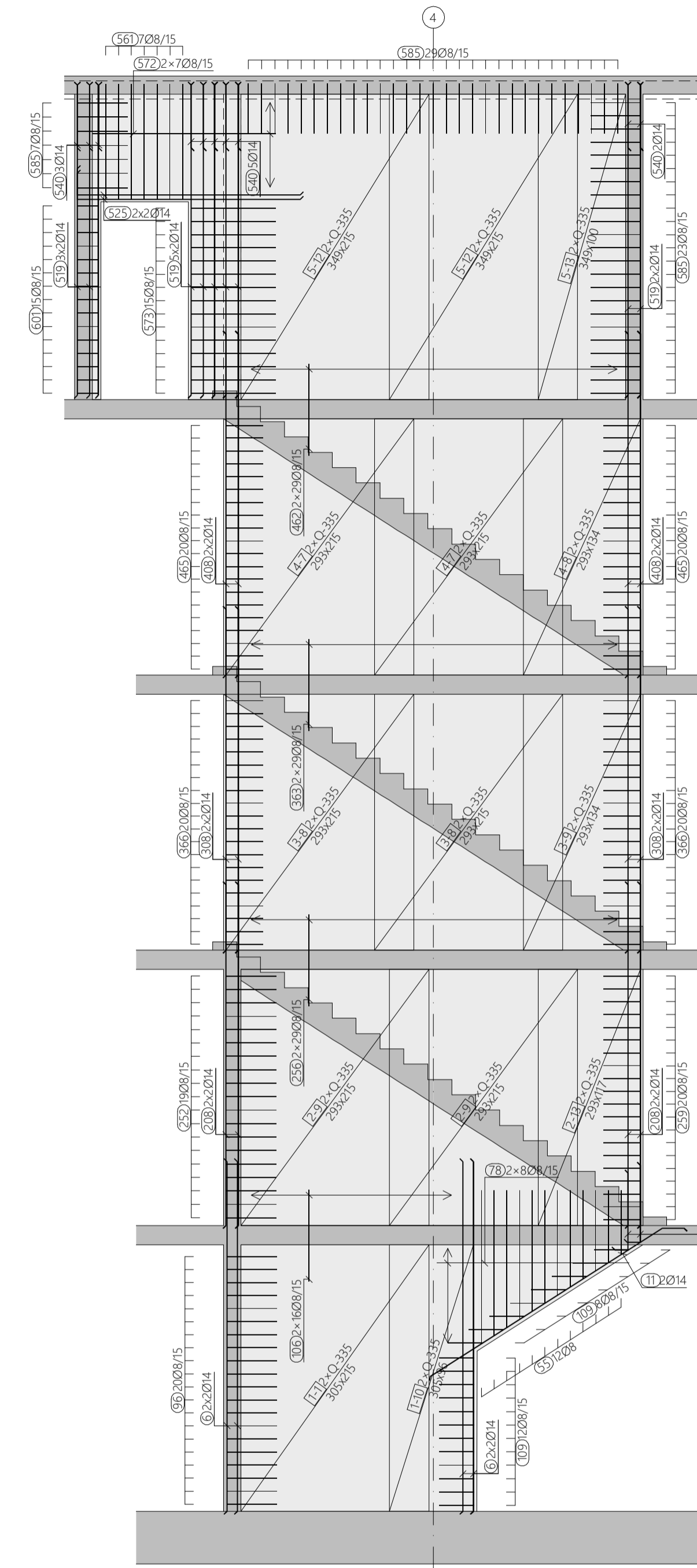

NAPOMENA
Šipke prilagoditi i po potrebi rezati na licu mjesta. Preklap 500.

NAPOMENA
Sve dimenzije provjeriti prema važećim planovima oplate.

Klasa betona	C 25/30
Armatura	B 500 B
Zaštitni sloj betona podzemnih zidova	Pripadajuća lista armature : ARM_E-1_605-611_ISKAZ
obostrano	
4,0 cm	
Zaštitni sloj betona nadzemnih zidova	Pripadajući armaturni nacrti ARM_E-1_605-607,609-611
obostrano	
3,0 cm	

DETALJ POSTAVLJANJA DISTANCERA U ZIDOVE SUTERENA

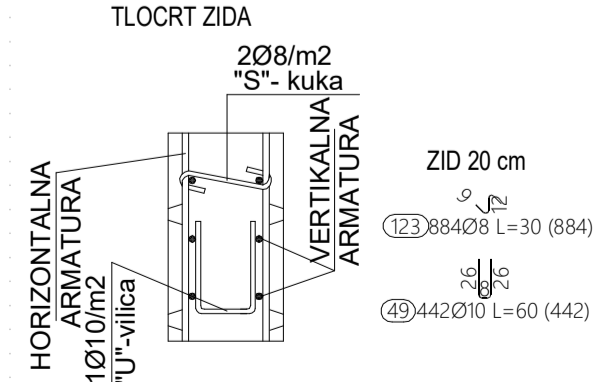

DETALJ POSTAVLJANJA DISTANCERA U ZIDOVE PRIZEMLJA

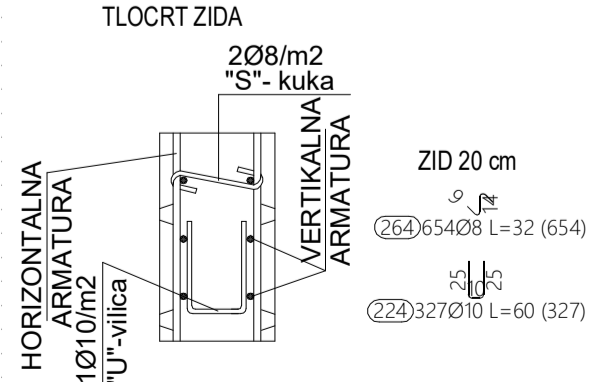

DETALJ POSTAVLJANJA DISTANCERA U ZIDOVE PRVOG KATA

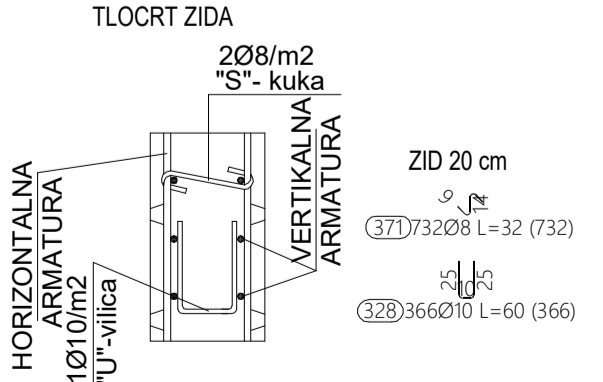

DETALJ POSTAVLJANJA DISTANCERA U ZIDOVE DRUGOG KATA

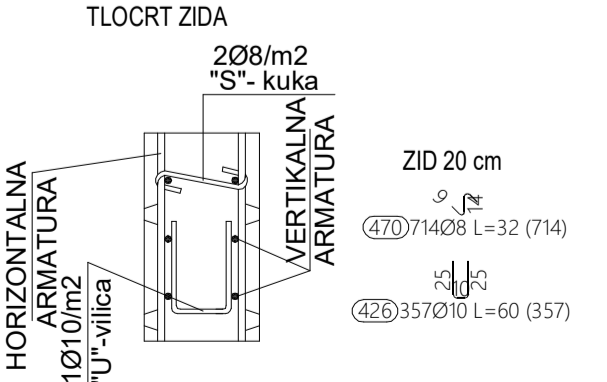

DETALJ POSTAVLJANJA DISTANCERA U ZIDOVE TREĆEG KATA

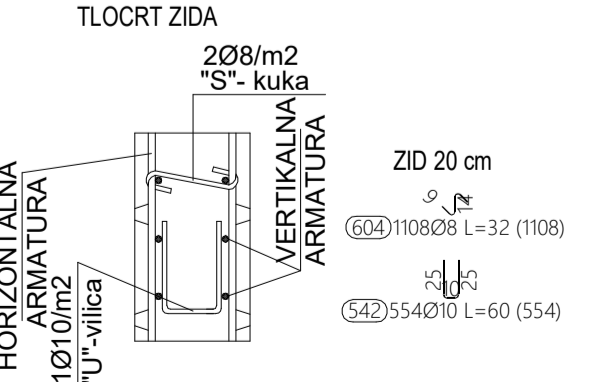

KONSTRUKTA
KONSTRUKTA d.o.o., za projektiranje i nadzor
 Desinićka 20, ZAGREB, OIB: 0667437879
 ŽR: PRIVREDNA BANKA 2340009-1110164468
 TEL: 01/36 43 828; FAX: 01/36 43 829
 MAIL: info@konstrukt.hr

PEČATI POTPIS:

 HRVATSKA KOMISIJA INŽINJERSKA ODGOVORNOSTA
 Antonio Maglov, dipl. ing. građ.
 Broj: 3775

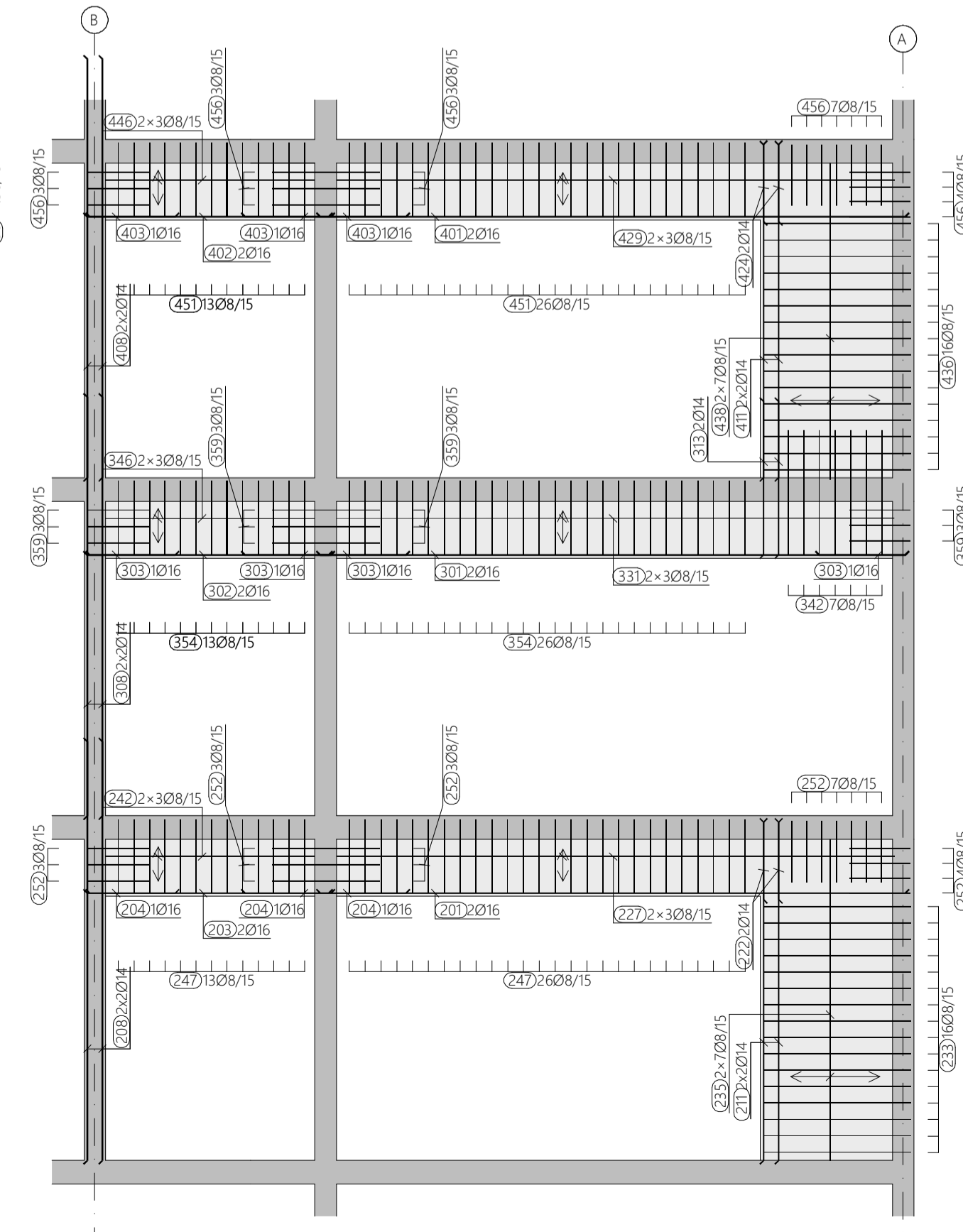
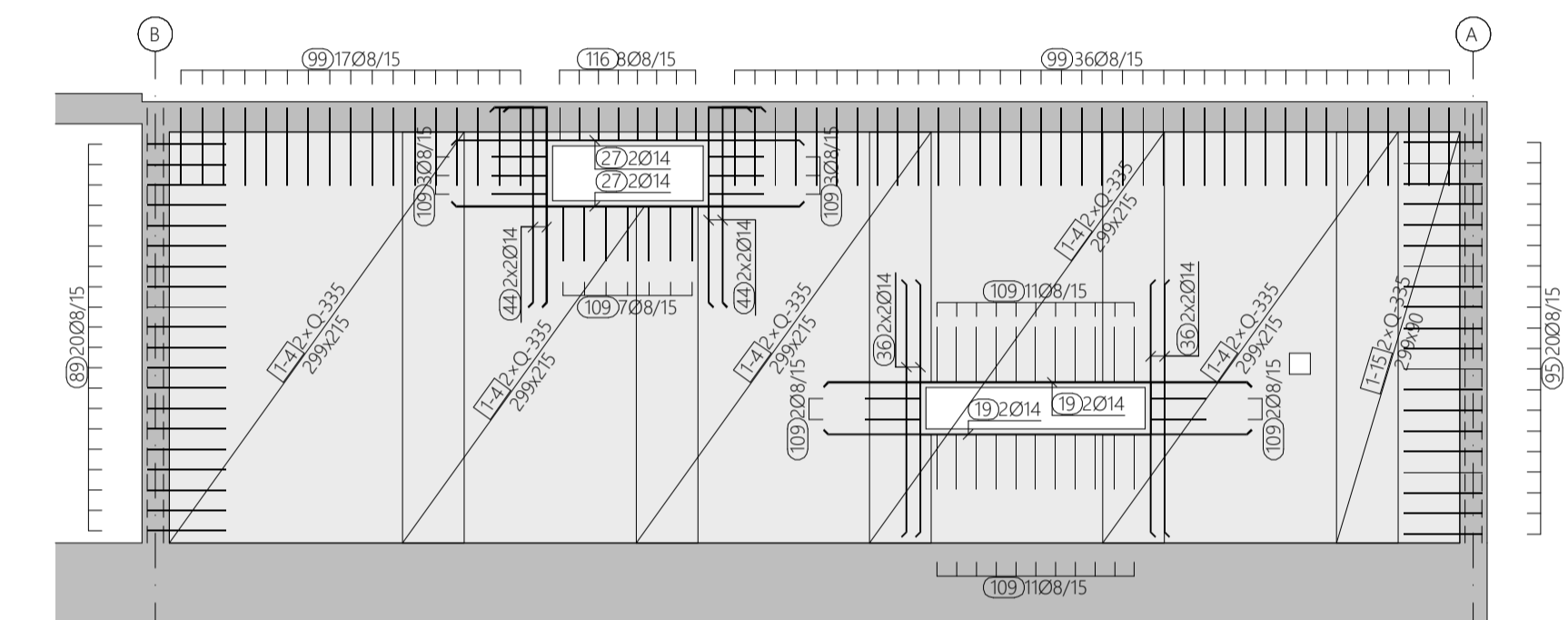
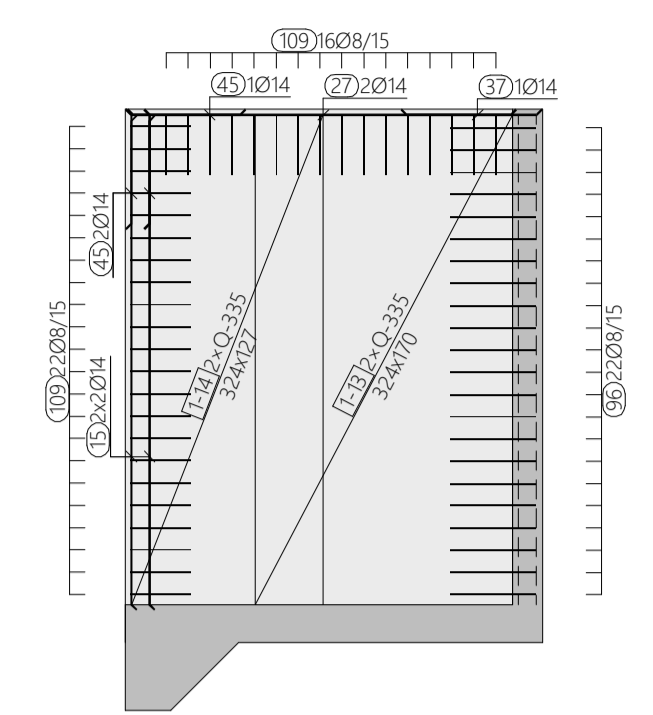
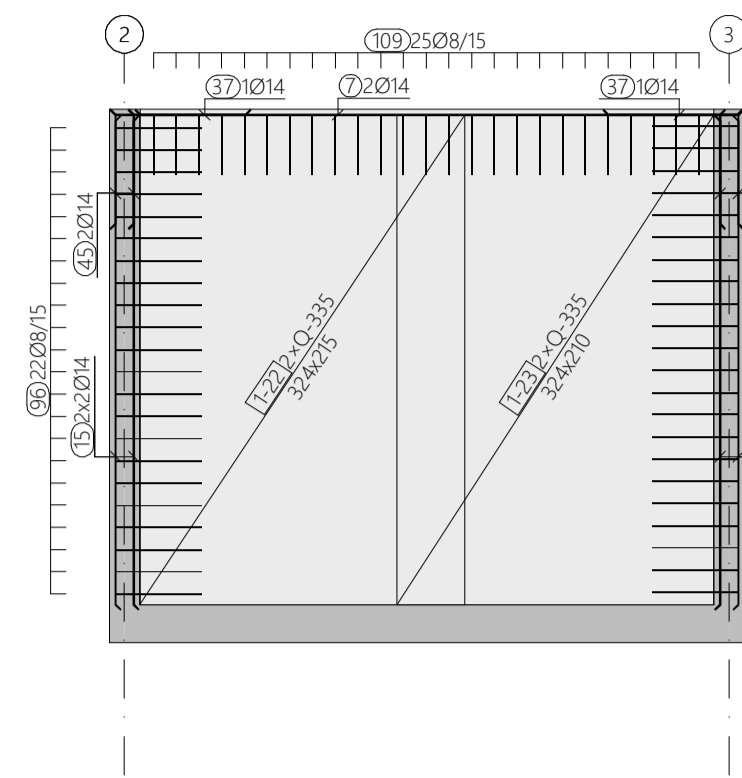
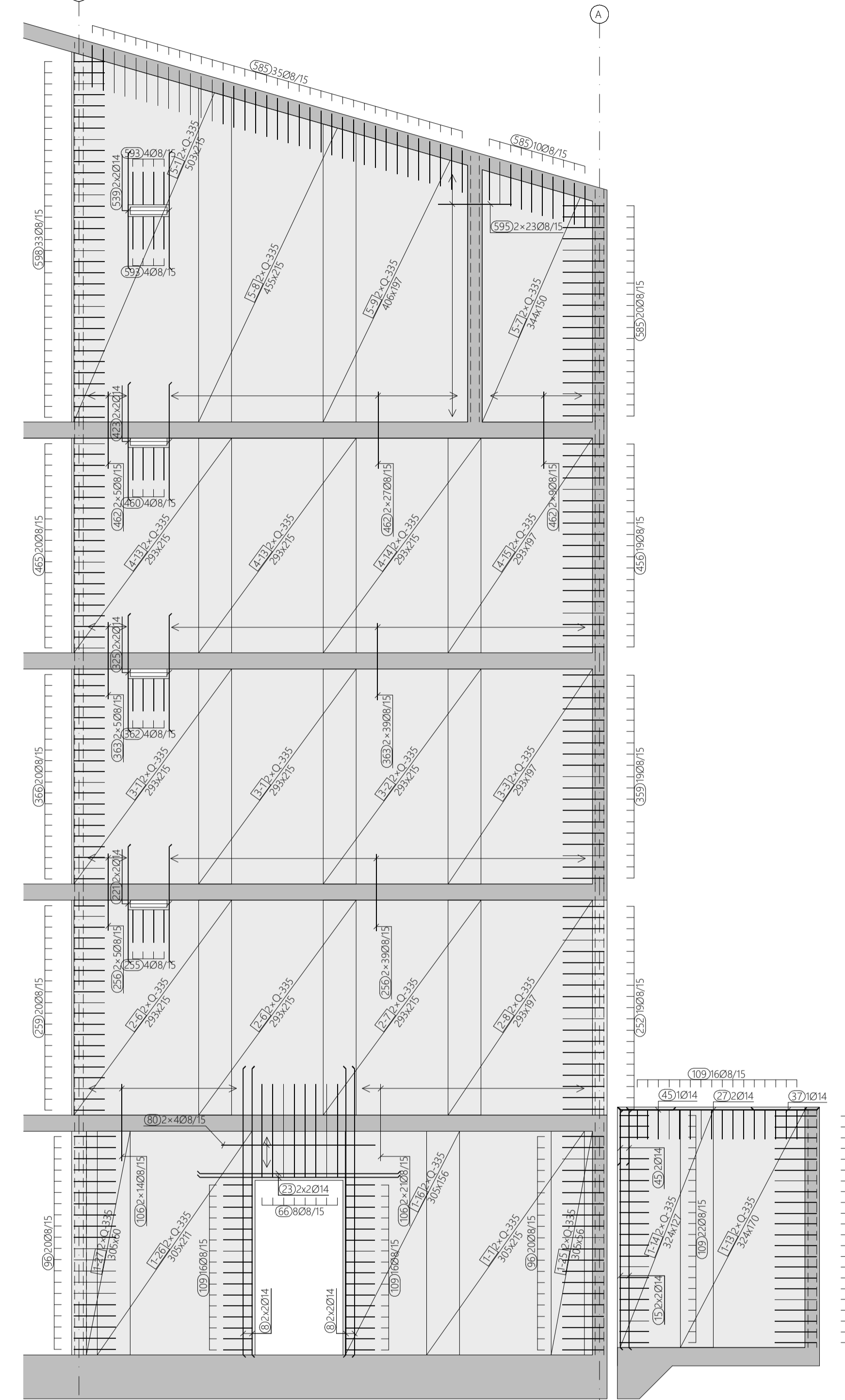
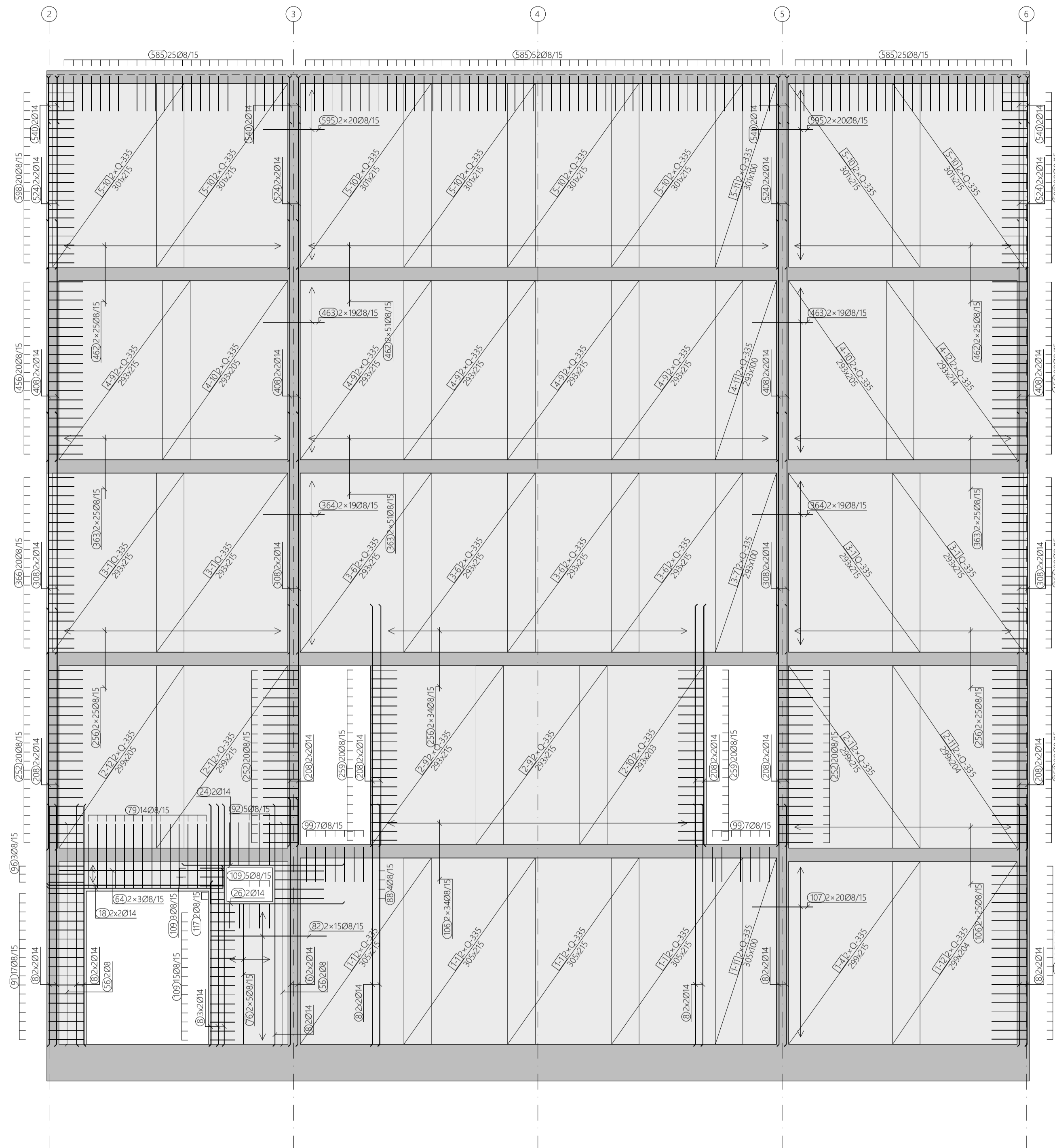
INVESTITOR:	TERME TUHELJ d.o.o. Ljudevita Gaja 4, Tuhelečke Toplice, 49215 Tuhej	GL. PROJEKTANT:	Tomislav Vreš, dipl. ing. arh.
GRAĐEVINA:	REKONSTRUKCIJA TERMANOG REKREACIJSKOG CENTRA TERME TUHELJ	PROJEKT. IZV. PR:	Antonio Maglov, dipl. ing. građ.
LOKACIJA:	na k.č.br. 3199/1, k.o. Črešnjevec	IZRADIO:	Antonio Maglov, dipl. ing. građ.
FAZA:	IZVEDBENI PROJEKT - ARMATURNI NACRTI	DATUM:	lipanj 2023.
SADRŽAJ:	ELEMENT - SMJEŠTAJNI PAVILJON ARMATURA ZIDOVA 4/7	MUERLO:	1:50
		REVIZIJA:	00
		NACRT BR.:	ARM - E-1 - 608



NAPOMENA
Šipke prilagoditi i po potrebi rezati na licu mjesta. Preklap 50Ø.

NAPOMENA
Sve dimenzije provjeriti prema važećim planovima oplate.

DETALJ POSTAVLJANJA DISTANCERA U ZIDOVE SUTERENA

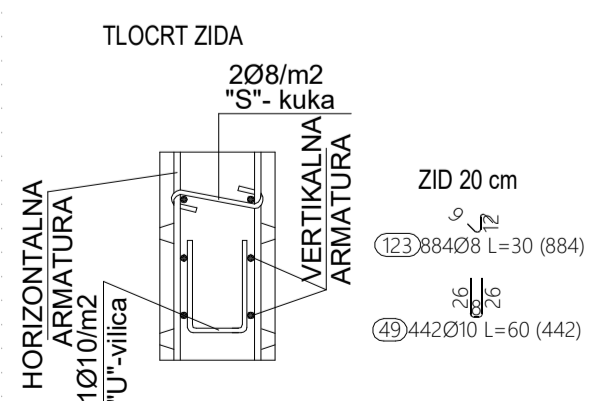

DETALJ POSTAVLJANJA DISTANCERA U ZIDOVE PRIZEMLJA

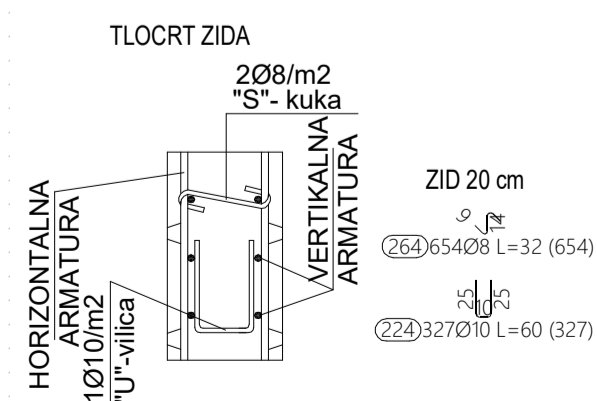

DETALJ POSTAVLJANJA DISTANCERA U ZIDOVE PRVOG KATA

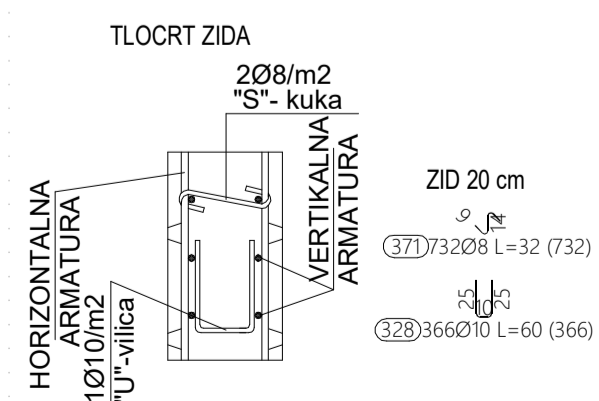

DETALJ POSTAVLJANJA DISTANCERA U ZIDOVE DRUGOG KATA

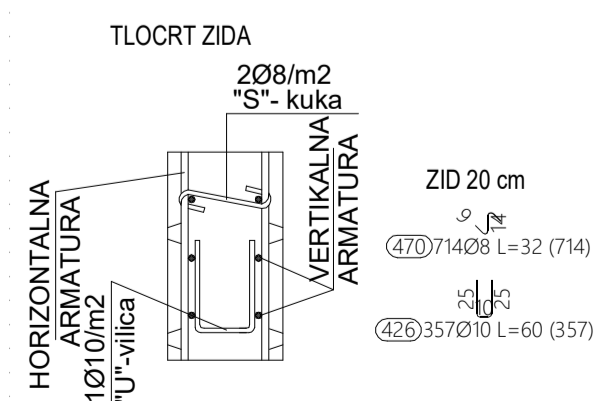

DETALJ POSTAVLJANJA DISTANCERA U ZIDOVE TREĆEG KATA

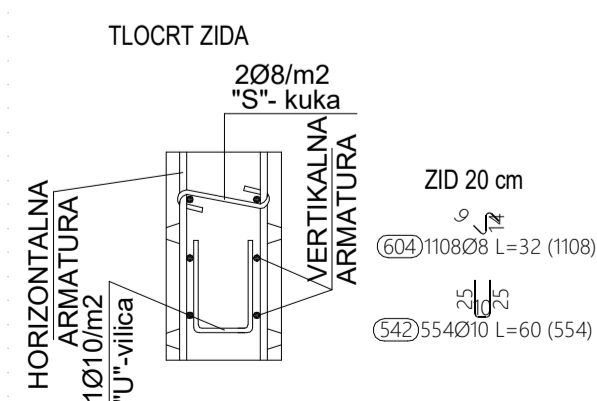

Klasa betona	C 25/30
Armatura	B 500 B
Zaštitni sloj betona podzemnih zidova	
obostrano	Pripadajuća lista armature :
4.0 cm	ARM_E-1_605-611_ISKAZ
Zaštitni sloj betona nadzemnih zidova	
obostrano	
3.0 cm	
Pripadajući armaturni nacrti	
	ARM_E-1_605-608.610-611

KONSTRUKTA
KONSTRUKTA d.o.o., za projektiranje i nadzor
 Desinićeva 20, ZAGREB, OIB: 0667437879
 ŽR: PRIVREDNA BANKA 2340009-1110164468
 TEL: 01/36 43 828; FAX: 01/36 43 829
 MAIL: info@konstrukt.hr

PEČATI POTPIS:
 INVESTITOR: TERME TUHELJ d.o.o. Ljudvita Gaja 4, Tuhelečke Toplice, 49215 Tuhej
 GRAĐEVINA: REKONSTRUKCIJA TERMALNOG REKREACIJSKOG CENTRA TERME TUHELJ
 LOKACIJA: na k.č.br. 3199/1, k.o. Črešnjevec
 FAZA: IZVEDBENI PROJEKT - ARMATURNI NACRTI
 SADRŽAJ: ELEMENT - SMJEŠTAJNI PAVILJON ARMATURA ZIDOVA 5/7

GL. PROJEKTANT: Tomislav Vreš, dipl. ing. arh.
 PROJEKT. IZV. PR: Antonio Maglov, dipl. ing. građ.
 IZRADIO: Antonio Maglov, dipl. ing. građ.
 DATUM: lipanj 2023.
 MUŠTERLO: 1:50
 REVIZIJA: 00
 NACRT BR: **ARM - E-1 - 609**

IZVODAK IZ VEŠTAČENJA
 Antonio Maglov, dipl. ing. građ.
 Ovlaštenje inženjera građevinarstva
 63715

POGLED NA KOSI ZID U OSI 3

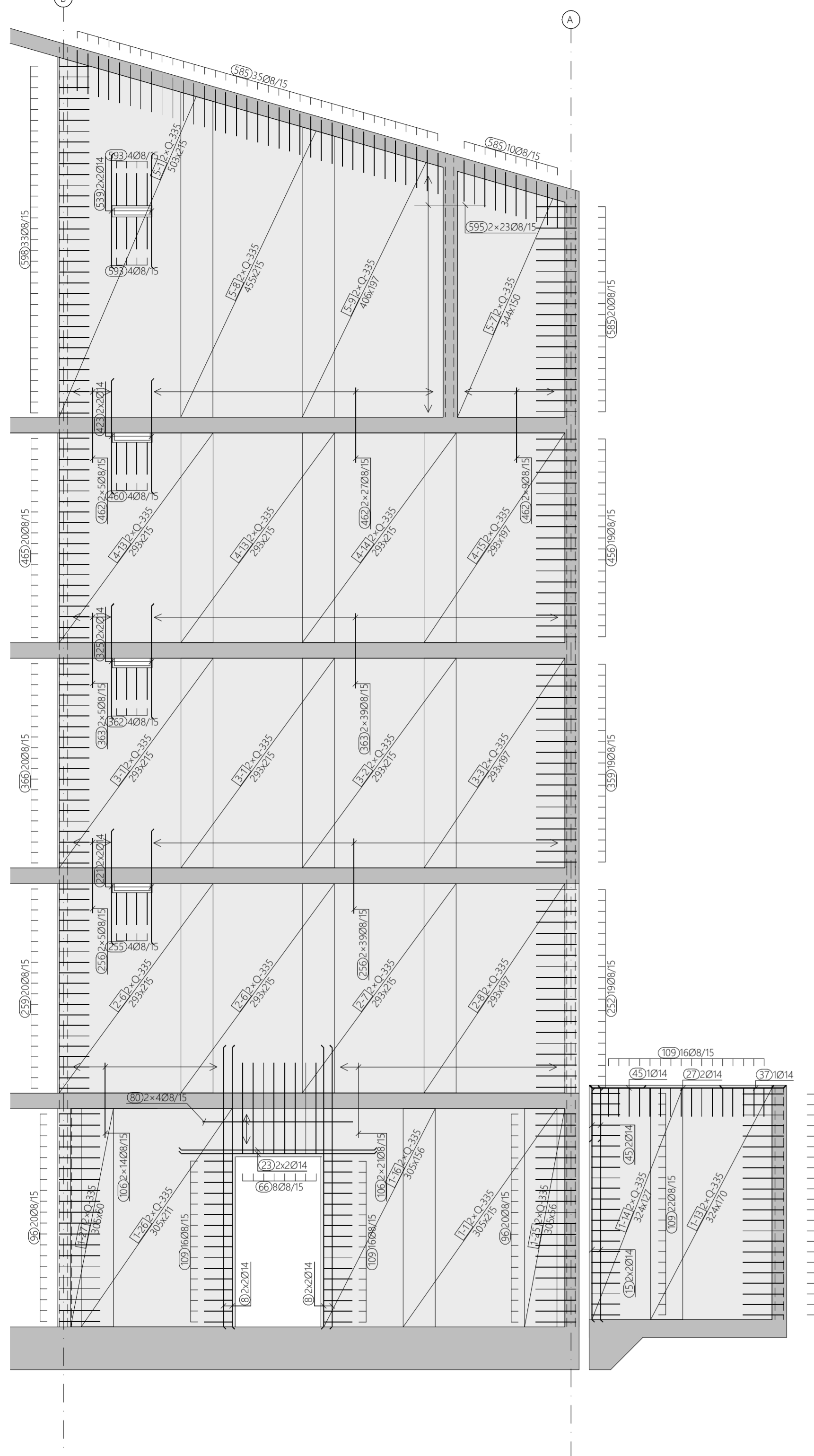

POGLED NA ZID IZMEĐU OSI 3 I 4

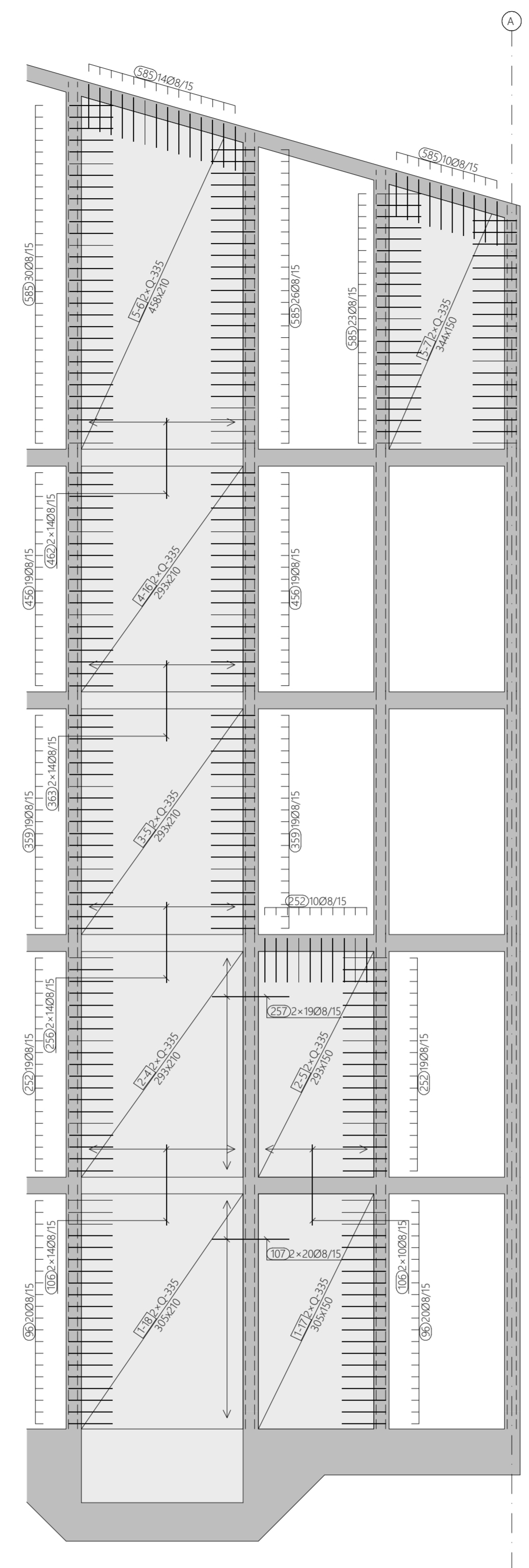

POGLED NA ZID U OSI 4

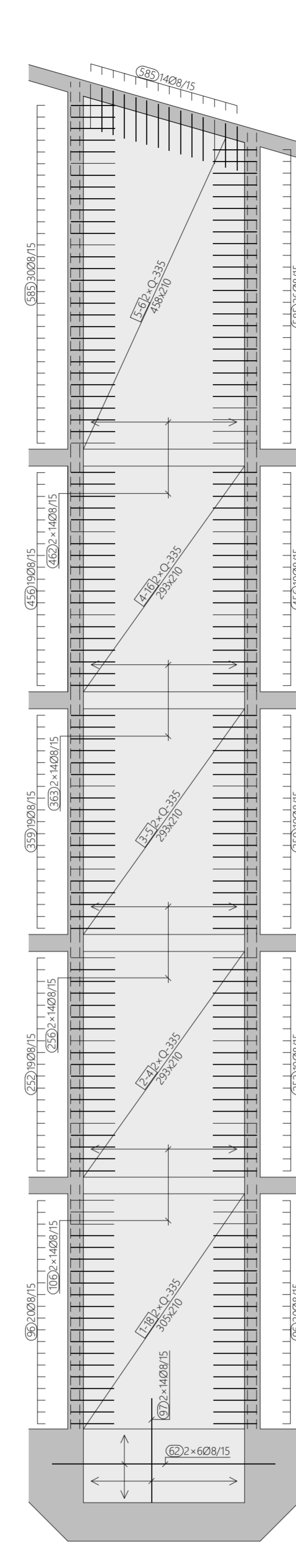

POGLED NA ZID IZMEĐU OSI 4 I 5

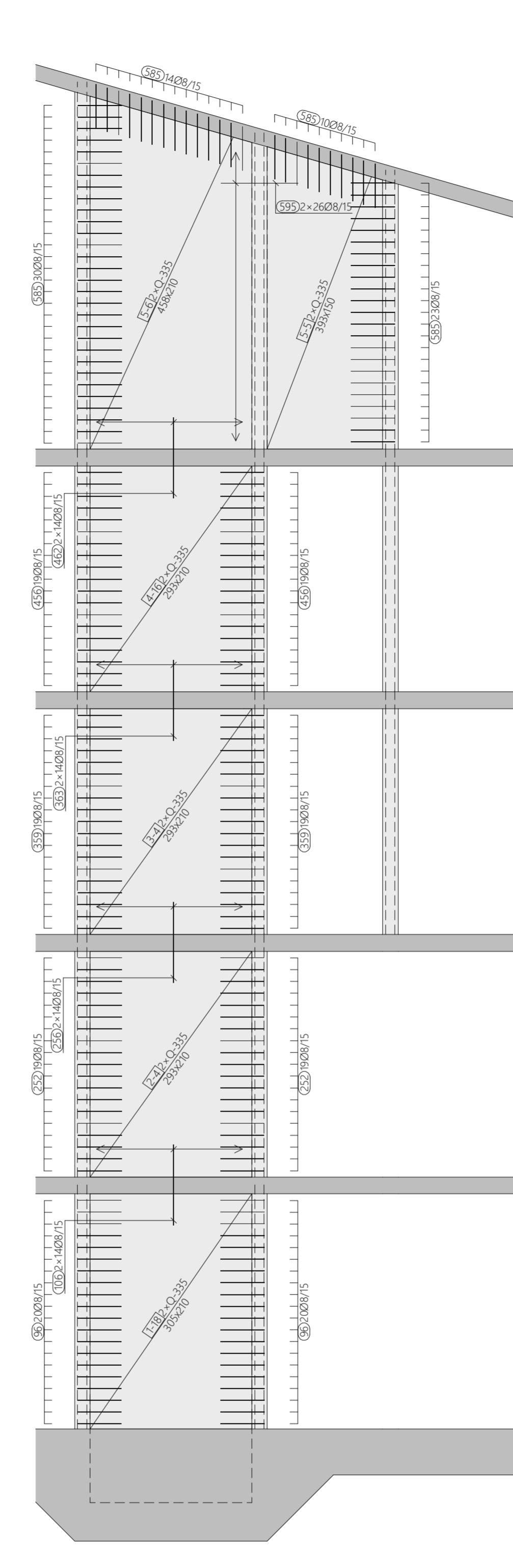

POGLED NA ZID U OSI 5

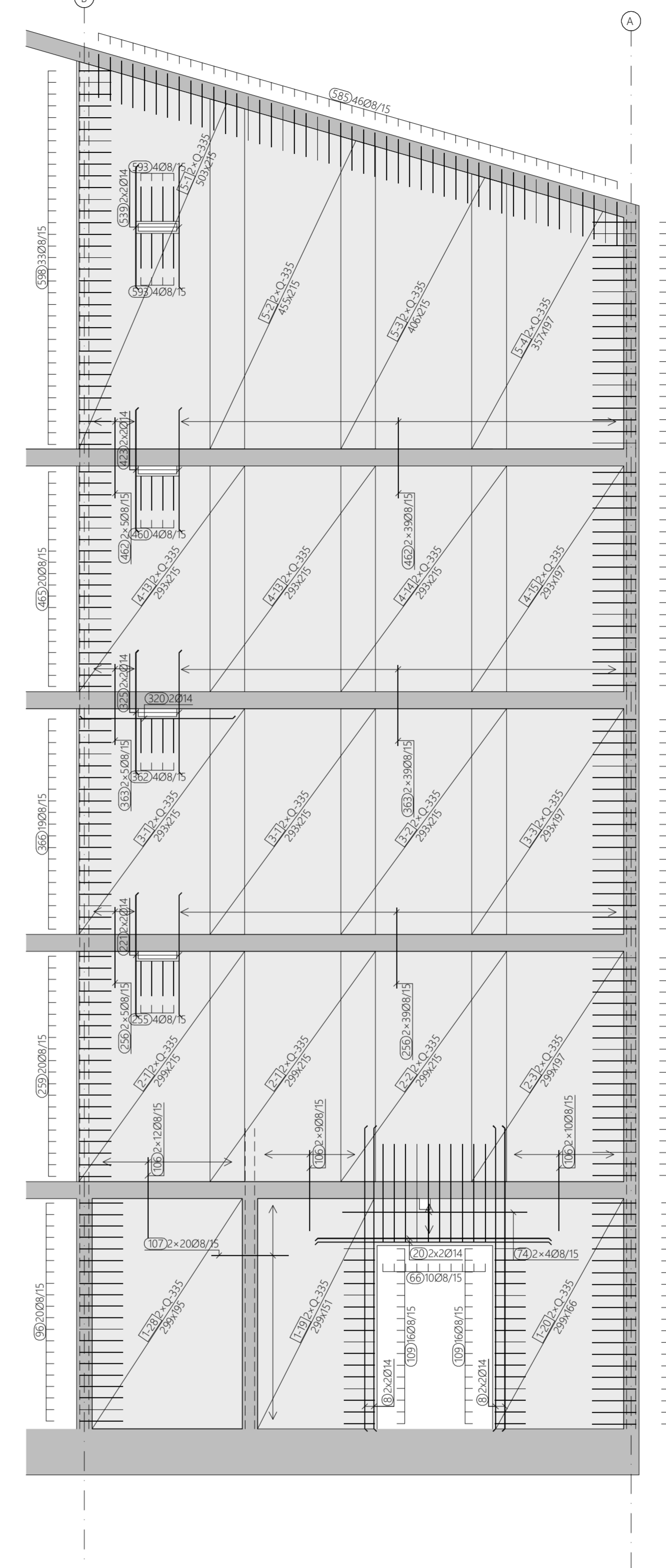

POGLED NA KOSI ZID U OSI 6

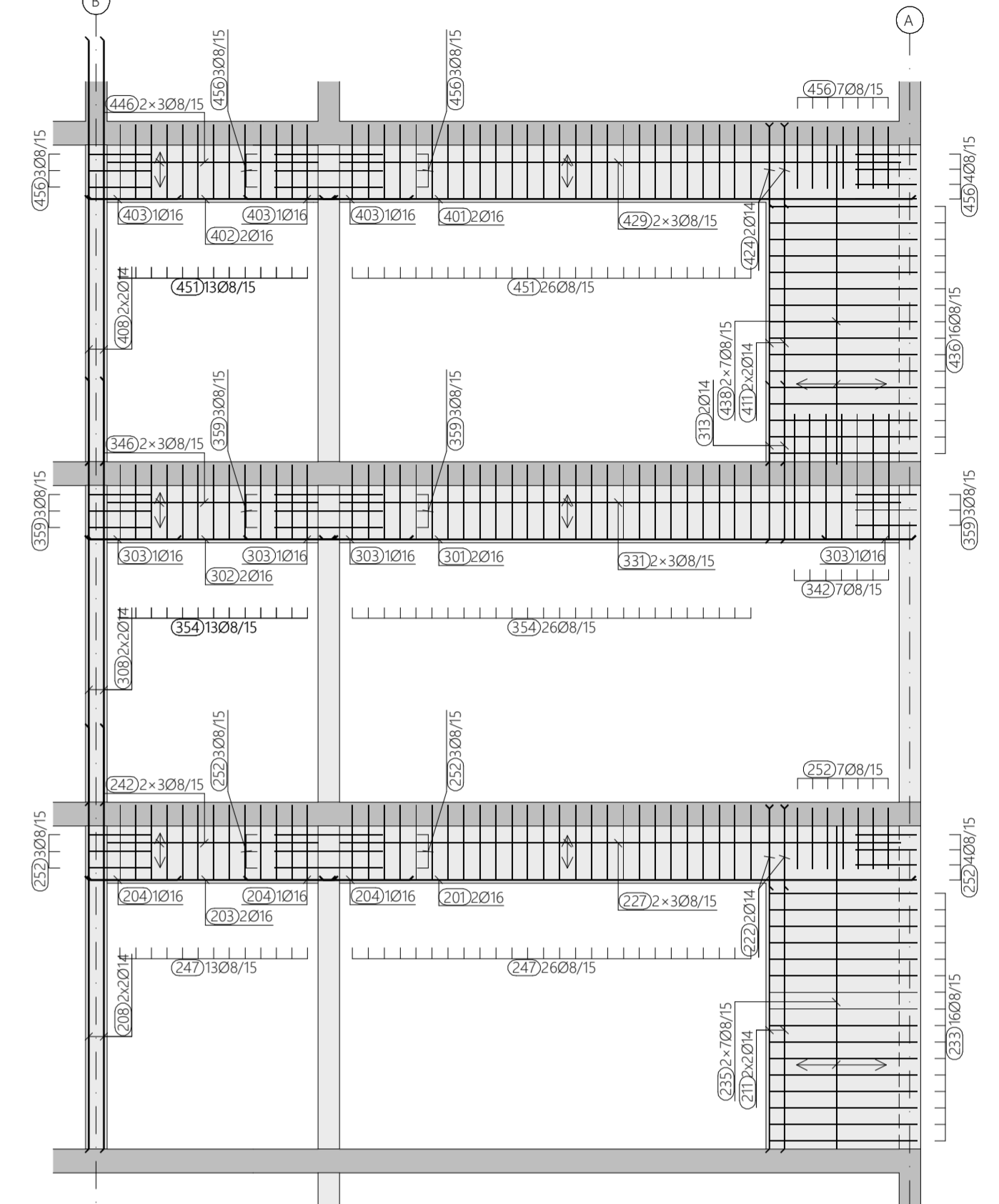

POGLED NA KOSI ZID IZMEĐU OSI 6 I 7

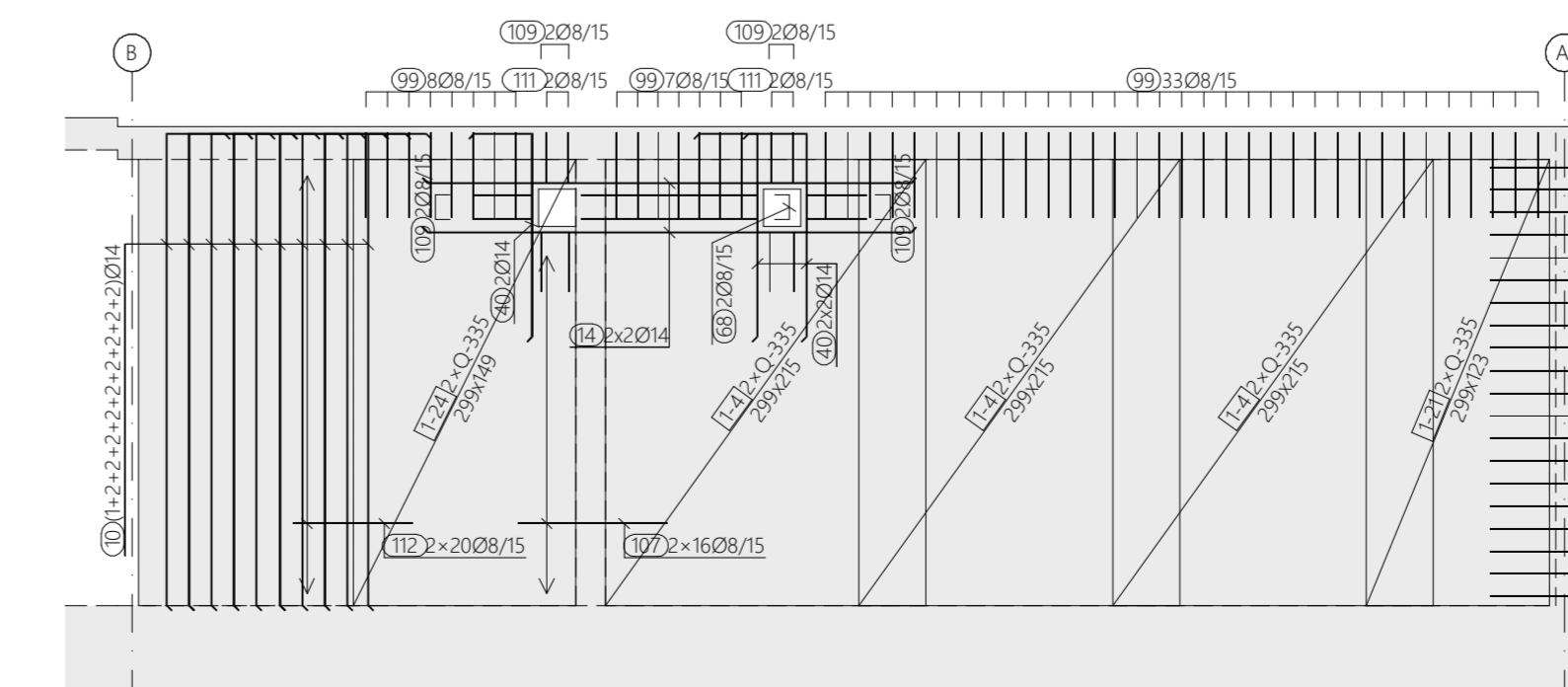

DETALJ POSTAVLJANJA DISTANCERA U ZIDOVE SUTERENA

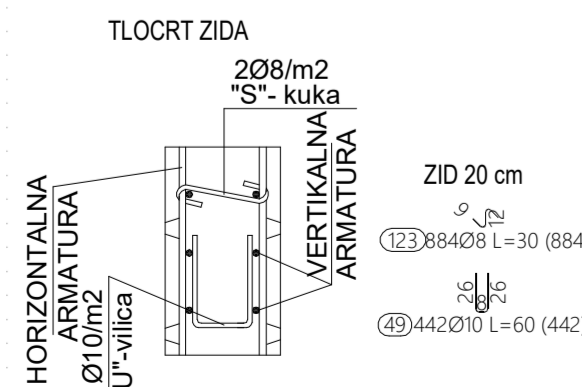

DETALJ POSTAVLJANJA DISTANCERA U ZIDOVE PRIZEMLJA

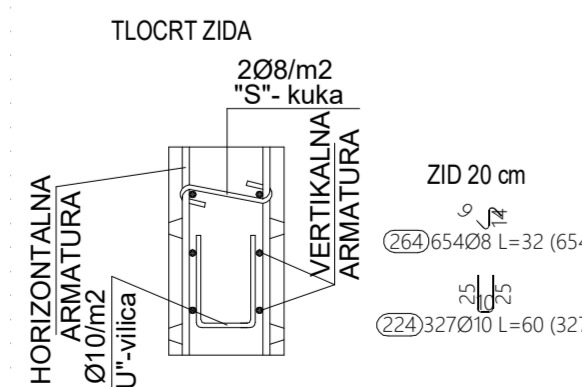

DETALJ POSTAVLJANJA DISTANCERA U ZIDOVE PRVOG KATA

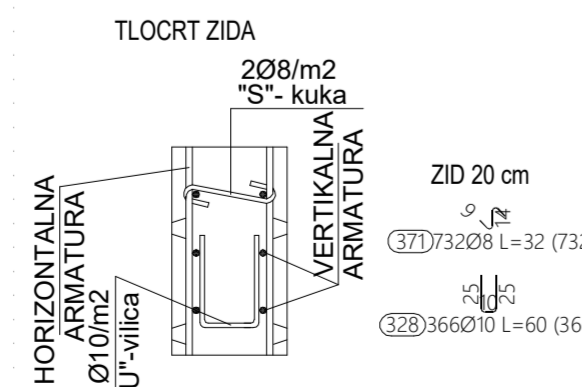

DETALJ POSTAVLJANJA DISTANCERA U ZIDOVE DRUGOG KATA

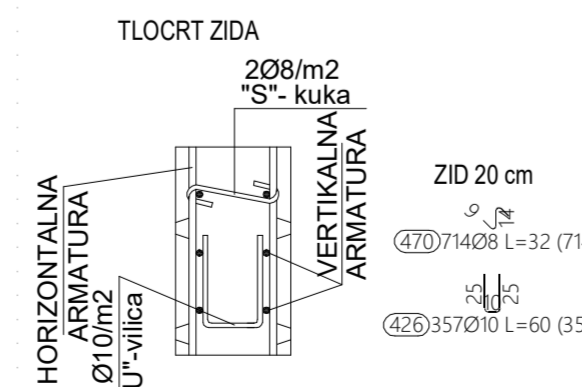

DETALJ POSTAVLJANJA DISTANCERA U ZIDOVE TREĆEG KATA

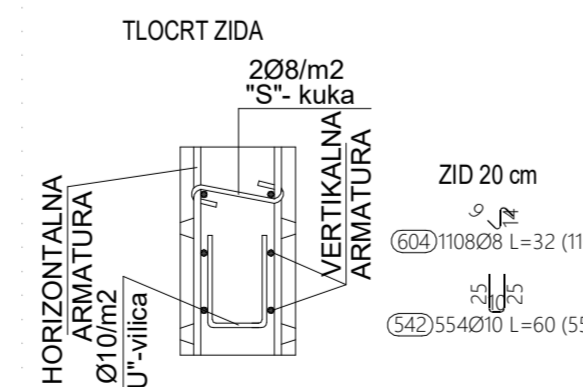

NAPOMENA
Šipke prilagoditi i po potrebi rezati na licu mjesta. Prekop 50Ø.

NAPOMENA
Sve dimenzije provjeriti prema važećim planovima optate.

Klasa betona	C 25/30
Armatura	B 500 B
Zaštitni sloj betona podzemnih zidova	Pripadajuća lista armature : ARM_E-1_605-611_ISKAZ
obostano	4,0 cm
Zaštitni sloj betona nadzemnih zidova	3,0 cm
obostano	
Pripadajući armaturni nacrti	ARM_E-1_605-609-611

KONSTRUKTA		PEČAT I POTPIS:	
INVESTITOR: TERME TUHELJ d.o.o. za projektiranje i nadzor Desimčića 20, ZAGREB, OIB: 9674378379 ŽR: PRIVREDNA BANKA 2340009-1110164468 TEL: 01/36 43 828; FAX: 01/36 43 829 MAIL: info@konstrukta.hr		GL. PROJEKTANT: Tomislav Vraš, dipl. ing. arh. PROJEKT. IZV. PR: Antonio Maglov, dipl. ing. građ. IZRADIO: Antonio Maglov, dipl. ing. građ.	
LOKACIJA: na k.č.br. 3199/1, k.o. Črešnjevec		DATUM: lipanj 2023.	
FAZA: IZVEDBENI PROJEKT - ARMATURNI NACRTI		MJESELO: 1:50 REVIZIJA: 00	
SADRŽAJ: ELEMENT - SMJEŠTAJNI PAVILJON ARMATURA ZIDOVA 6/7		NACRT BR: ARM - E-1 - 610	

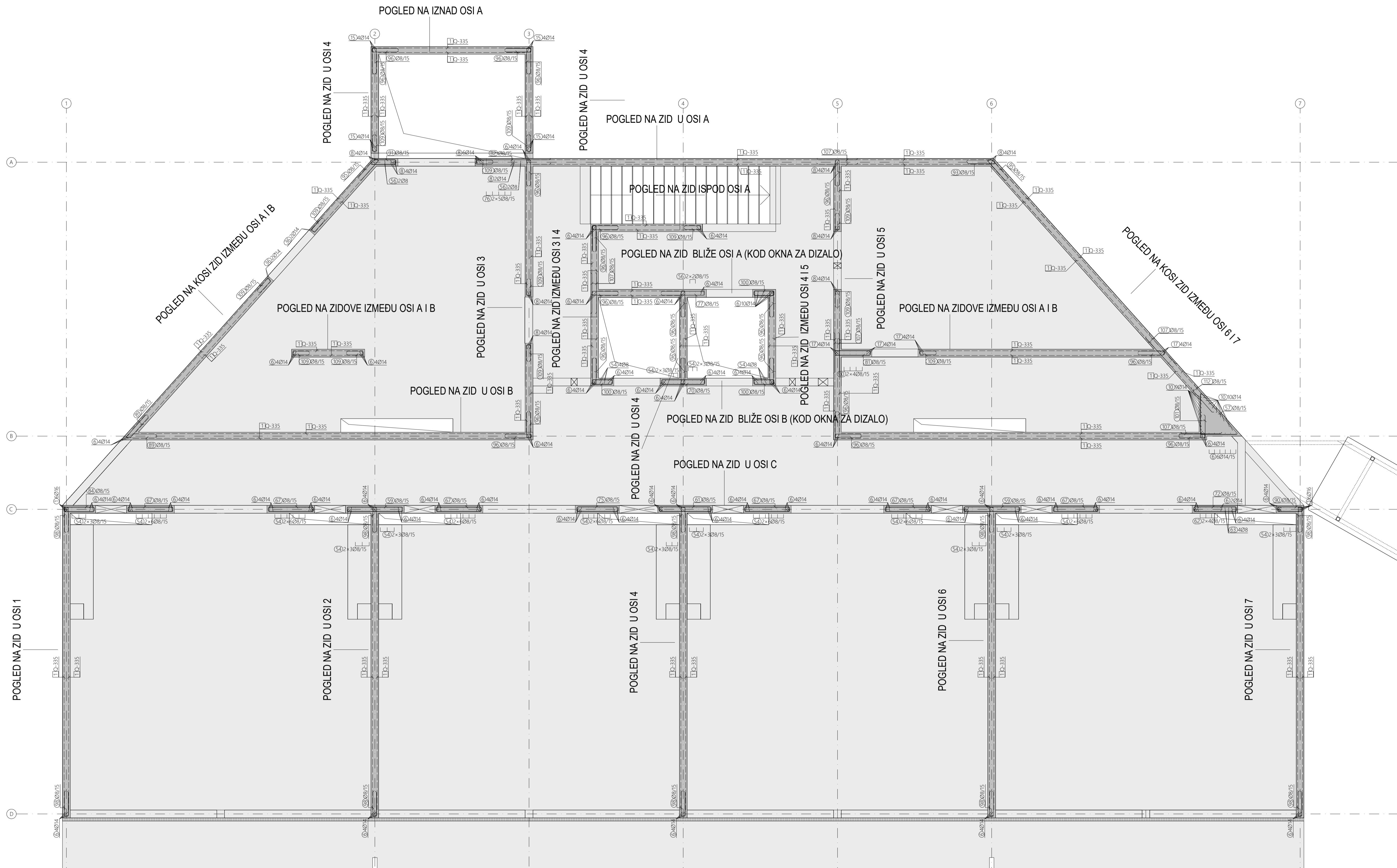

NAPOMENA
Šipke prilagoditi i po potrebi rezati na licu mjesta. Preklap 50Ø.

NAPOMENA
Sve dimenzije provjeriti prema važećim planovima optate.





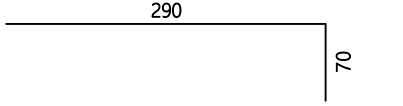
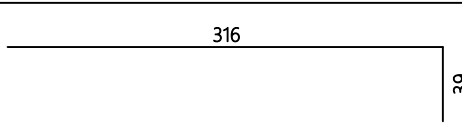
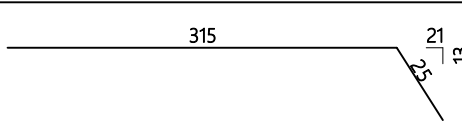
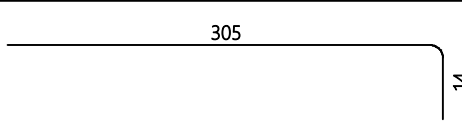
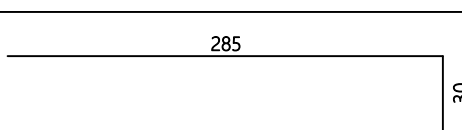

Klasa betona	C 25/30
Armatura	B 500 B
Zaštitni sloj betona podzemnih zidova	
obostrano	Pripadajuća lista armature :
4.0 cm	ARM_E-1_605-611_ISKAZ
Zaštitni sloj betona nadzemnih zidova	
obostrano	
3.0 cm	
Pripadajući armaturni nacrti	
ARM_E-1_605-610	

KONSTRUKTA KONSTRUKTA d.o.o., za projektiranje i nadzor Desinićka 20, ZAGREB, OIB: 06674378579 ZR: PRIVREDNA BANKA 2340009-1110164468 TEL: 01/36 43 828; FAX: 01/36 43 829 MAIL: info@konstrukta.hr		PEČATI POTPIS:  ANTONIO MAGLOV dijelovoditelj građevinarstva 63775	
INVESTITOR:	TERME TUHELJ d.o.o. Ljudevita Gaja 4, Tuhelečke Toplice, 49215 Tuhej	GL. PROJEKTANT:	Tomislav Vreš, dipl. ing. arh.
GRADEVINA:	REKONSTRUKCIJA TERMINALNOG REKREACIJSKOG CENTRA TERME TUHELJ	PROJEKT. IZV. PR:	Antonio Maglov, dipl. ing. grad.
LOKACIJA:	na k.č.br. 3199/1, k.o. Črešnjevec	IZRAĐIO:	Antonio Maglov, dipl. ing. grad.
FAZA:	IZVEDBENI PROJEKT - ARMATURNI NACRTI	DATUM:	lipanj 2023.
SADRŽAJ:	ELEMENT - SMJEŠTAJNI PAVILJON ARMATURA ZIDOVA 7/7	MUERLO:	1:50
		REVIZIA:	00
		NACRT BR.:	ARM - E-1 - 611

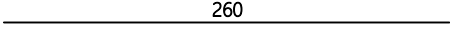
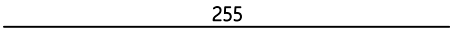
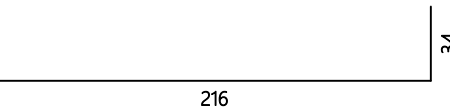
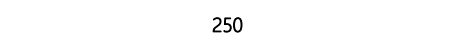
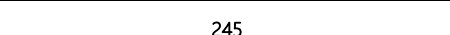
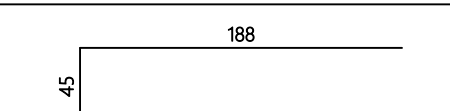
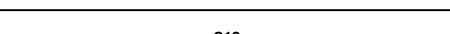
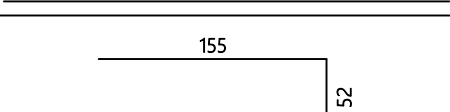
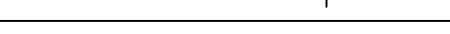
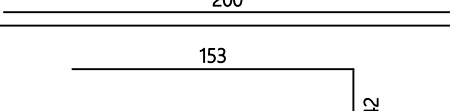

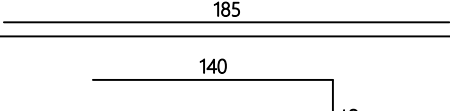
ISKAZ ARMATURE	
GRAĐEVINA:	TERME TUHELJ- SMJEŠTAJNI PAVILJON
ISKAZ UZ NACRT:	ARM_E-1_605-611
SADRŽAJ:	NACRT SAVIJANJA ARMATURE ZIDOVA
DATUM:	Lipanj, 2023. 1/34

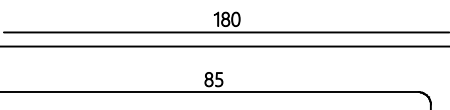
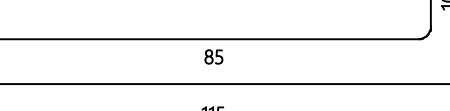
Šipke - specifikacija						
ozn	oblik i mjere [cm]	Ø	lg [m]	n [kom]	lgn [m]	Napomena
Suteren (1 kom)						
1	400	16	4.00	12	48.00	
2	550	14	5.50	28	154.00	
3	480	14	4.80	8	38.40	
4	470	14	4.70	8	37.60	
5	425	14	4.25	4	17.00	
6	400	14	4.00	236	944.00	
7	395	14	3.95	2	7.90	
8	390	14	3.90	48	187.20	
9	290 	14	3.60	2	7.20	
10	316 	14	3.55	19	67.45	
11	315 	14	3.40	2	6.80	
12	340	14	3.40	8	27.20	
13	336	14	3.36	2	6.72	
14	324	14	3.24	4	12.96	
15	320	14	3.20	16	51.20	
16	305 	14	3.19	4	12.76	
17	315	14	3.15	16	50.40	
18	285 	14	3.15	4	12.60	
19	305	14	3.05	4	12.20	
20	300	14	3.00	4	12.00	
21	290	14	2.90	4	11.60	
22	280	14	2.80	12	33.60	
23	270	14	2.70	4	10.80	

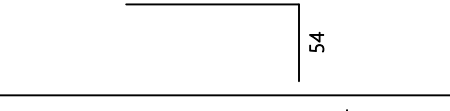
ISKAZ ARMATURE		
GRAĐEVINA:	TERME TUHELJ- SMJEŠTAJNI PAVILJON	
ISKAZ UZ NACRT:	ARM_E-1_605-611	
SADRŽAJ:	NACRT SAVIJANJA ARMATURE ZIDOVA	
DATUM:	Svibanj, 2023.	2/34

Šipke - specifikacija						
ozn	oblik i mjere [cm]	Ø	lg [m]	n [kom]	lgn [m]	Napomena
24		14	2.60	2	5.20	
25		14	2.55	8	20.40	
26		14	2.50	2	5.00	
27		14	2.50	8	20.00	
28		14	2.45	2	4.90	
29		14	2.33	2	4.66	
30		14	2.10	4	8.40	
31		14	2.07	2	4.14	
32		14	2.00	2	4.00	
33		14	1.95	4	7.80	
34		14	1.85	4	7.40	
35		14	1.85	2	3.70	
36		14	1.80	18	32.40	
37		14	1.80	4	7.20	
38		14	1.75	10	17.50	
39		14	1.75	2	3.50	
40		14	1.75	6	10.50	

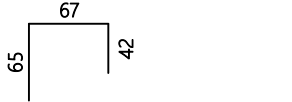
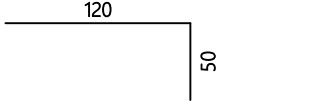
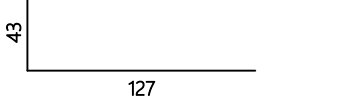

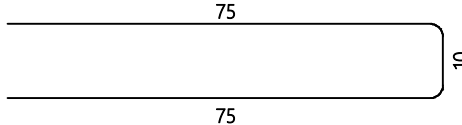
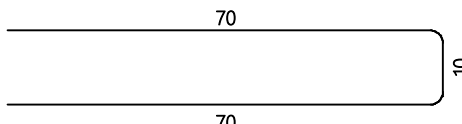
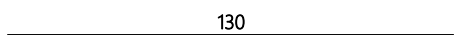
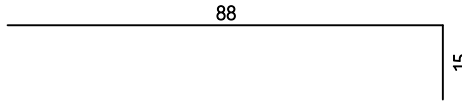
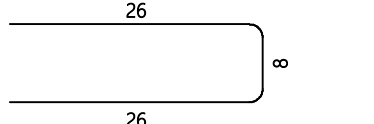
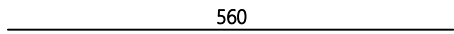
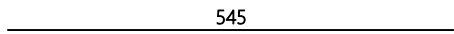
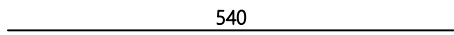
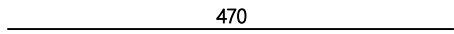
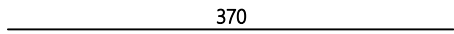
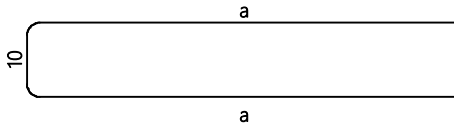

ISKAZ ARMATURE		
GRAĐEVINA:	TERME TUHELJ- SMJEŠTAJNI PAVILJON	
ISKAZ UZ NACRT:	ARM_E-1_605-611	
SADRŽAJ:	NACRT SAVIJANJA ARMATURE ZIDOVA	
DATUM:	Svibanj, 2023.	3/34

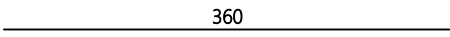
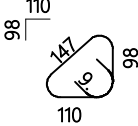
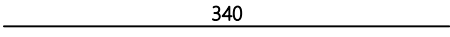
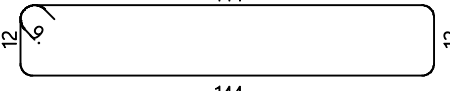
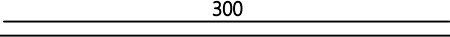
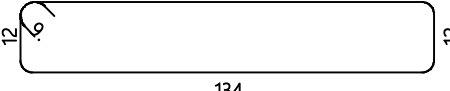
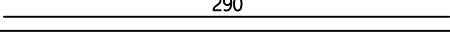
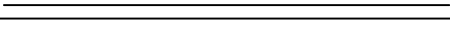
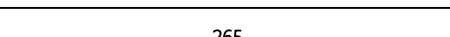
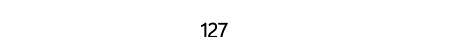
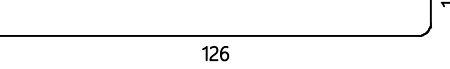
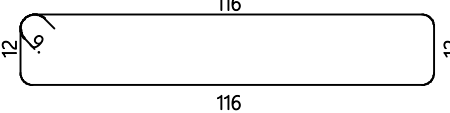
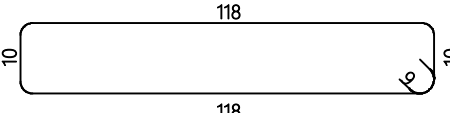
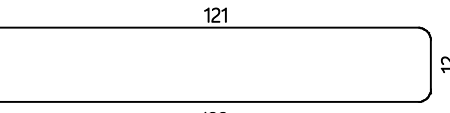
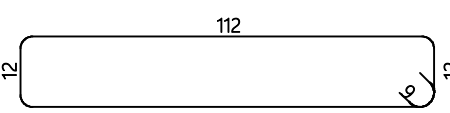
Šipke - specifikacija						
ozn	oblik i mjere [cm]	Ø	lg [m]	n [kom]	lgn [m]	Napomena
41		14	1.74	2	3.48	
42		14	1.70	2	3.40	
43		14	1.70	2	3.40	
44		14	1.70	8	13.60	
45		14	1.60	10	16.00	
46		14	1.50	12	18.00	
47		14	1.30	2	2.60	
48		14	1.03	4	4.12	
49		10	0.60	442	265.20	
50		8	5.60	4	22.40	
51		8	5.45	24	130.80	
52		8	5.40	2	10.80	
53		8	4.70	4	18.80	
54		8	3.70	152	562.40	
55	 a = 73, 83, 92, 101, 110, 120, 129, 138, 148, 157, 166, 176	8	*2.59	1 x 12	31.06	

ISKAZ ARMATURE		
GRAĐEVINA:	TERME TUHELJ- SMJEŠTAJNI PAVILJON	
ISKAZ UZ NACRT:	ARM_E-1_605-611	
SADRŽAJ:	NACRT SAVIJANJA ARMATURE ZIDOVA	
DATUM:	Svibanj, 2023.	4/34

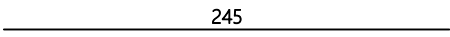
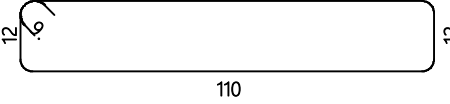
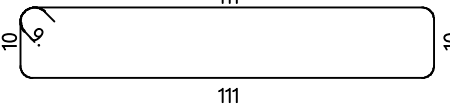
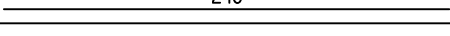
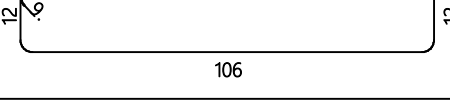
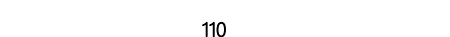
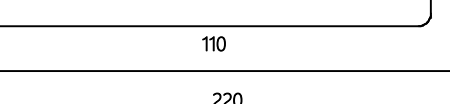
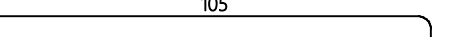
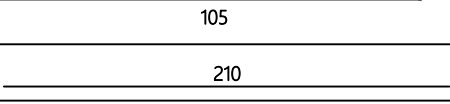
Šipke - specifikacija						
ozn	oblik i mjere [cm]	Ø	lg [m]	n [kom]	lgn [m]	Napomena
56		8	3.60	8	28.80	
57		8	3.73	20	74.60	
58		8	3.40	6	20.40	
59		8	3.30	24	79.20	
60		8	3.00	8	24.00	
61		8	3.10	14	43.40	
62		8	2.90	18	52.20	
63		8	2.85	4	11.40	
64		8	2.70	12	32.40	
65		8	2.65	7	18.55	
66		8	2.65	18	47.70	
67		8	2.74	72	197.28	
68		8	2.74	2	5.48	
69		8	2.55	8	20.40	
70		8	2.66	16	42.56	

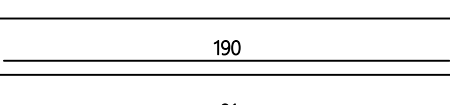
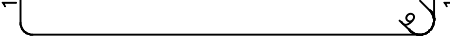
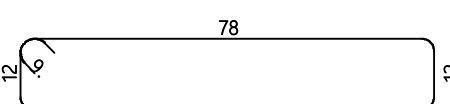
ISKAZ ARMATURE		
GRAĐEVINA:	TERME TUHELJ- SMJEŠTAJNI PAVILJON	
ISKAZ UZ NACRT:	ARM_E-1_605-611	
SADRŽAJ:	NACRT SAVIJANJA ARMATURE ZIDOVA	
DATUM:	Svibanj, 2023.	5/34

Šipke - specifikacija						
ozn	oblik i mjere [cm]	Ø	lg [m]	n [kom]	lgn [m]	Napomena
71		8	2.45	6	14.70	
72		8	2.62	19	49.78	
73		8	2.60	1	2.60	
74		8	2.40	8	19.20	
75		8	2.54	16	40.64	
76		8	2.30	10	23.00	
77		8	2.30	16	36.80	
78		8	2.20	16	35.20	
79		8	2.20	14	30.80	
80		8	2.10	8	16.80	
81		8	2.26	16	36.16	
82		8	1.90	30	57.00	
83		8	2.04	16	32.64	
84		8	1.98	13	25.74	

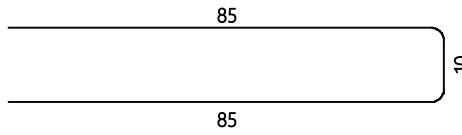
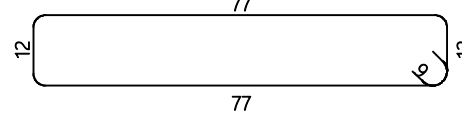
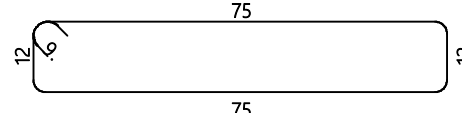
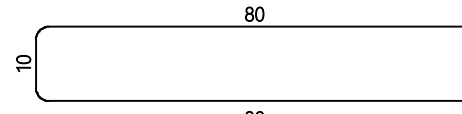
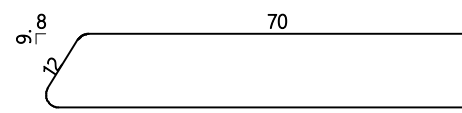
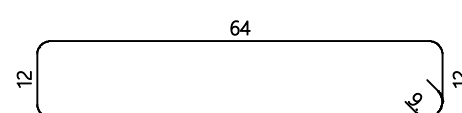
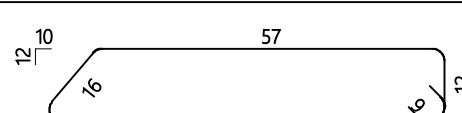
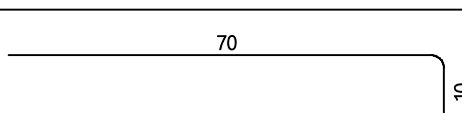
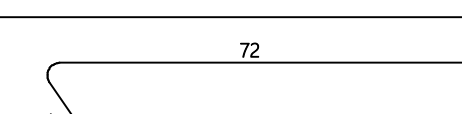
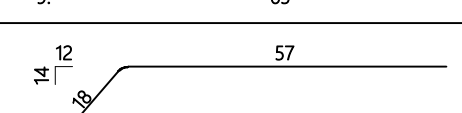

ISKAZ ARMATURE		
GRAĐEVINA:	TERME TUHELJ- SMJEŠTAJNI PAVILJON	
ISKAZ UZ NACRT:	ARM_E-1_605-611	
SADRŽAJ:	NACRT SAVIJANJA ARMATURE ZIDOVA	
DATUM:	Svibanj, 2023.	6/34

Šipke - specifikacija						
ozn	oblik i mjere [cm]	Ø	lg [m]	n [kom]	lgn [m]	Napomena
85		8	1.80	3	5.40	
86		8	1.96	30	58.80	
87		8	1.92	8	15.36	
88		8	1.70	4	6.80	
89		8	1.60	40	64.00	
90		8	1.70	20	34.00	
91		8	1.70	19	32.30	
92		8	1.50	5	7.50	
93		8	1.50	20	30.00	
94		8	1.45	8	11.60	

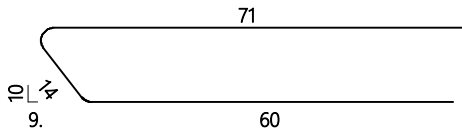
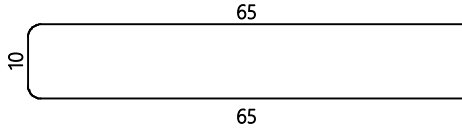
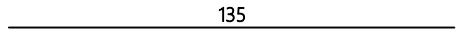
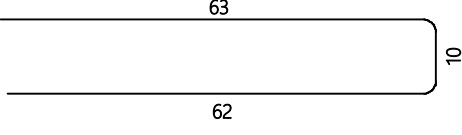
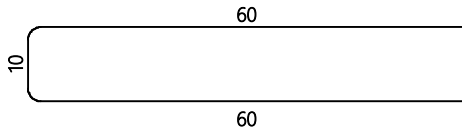
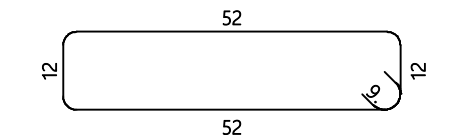
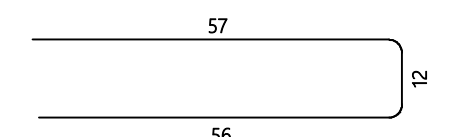
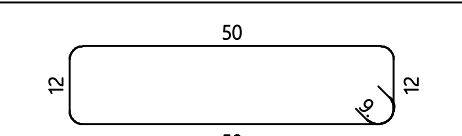
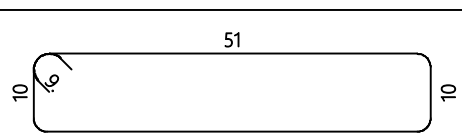
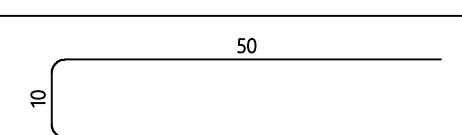
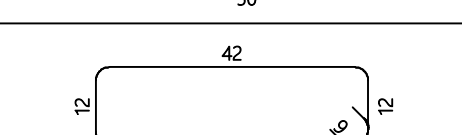
ISKAZ ARMATURE		
GRAĐEVINA:	TERME TUHELJ- SMJEŠTAJNI PAVILJON	
ISKAZ UZ NACRT:	ARM_E-1_605-611	
SADRŽAJ:	NACRT SAVIJANJA ARMATURE ZIDOVA	
DATUM:	Svibanj, 2023.	7/34

Šipke - specifikacija						
ozn	oblik i mjere [cm]	Ø	lg [m]	n [kom]	lgn [m]	Napomena
95		8	1.45	20	29.00	
96		8	1.40	435	609.00	
97		8	1.35	28	37.80	
98		8	1.35	200	270.00	
99		8	1.30	151	196.30	
100		8	1.46	48	70.08	
101		8	1.25	20	25.00	
102		8	1.42	2	2.84	
103		8	1.40	1	1.40	
104		8	1.10	43	47.30	
105		8	1.26	79	99.54	

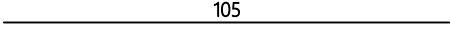
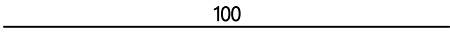
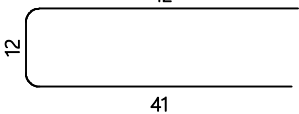
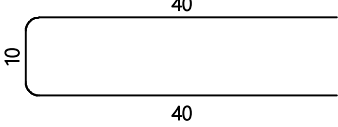

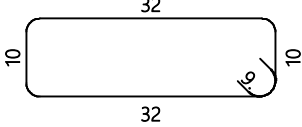
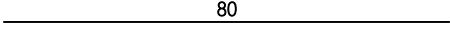
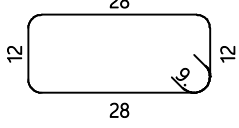
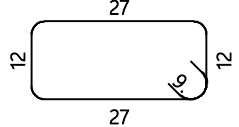
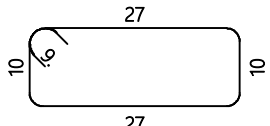
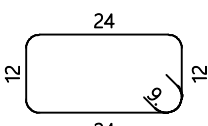
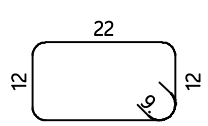

ISKAZ ARMATURE		
GRAĐEVINA:	TERME TUHELJ- SMJEŠTAJNI PAVILJON	
ISKAZ UZ NACRT:	ARM_E-1_605-611	
SADRŽAJ:	NACRT SAVIJANJA ARMATURE ZIDOVA	
DATUM:	Svibanj, 2023.	8/34

Šipke - specifikacija						
ozn	oblik i mjere [cm]	Ø	lg [m]	n [kom]	lgn [m]	Napomena
106	 105	8	1.05	1136	1192.80	
107	 100	8	1.00	172	172.00	
108	 42 12 41	8	0.95	102	96.90	
109	 40 10 40	8	0.90	318	286.20	
110	 37 12 36	8	0.85	43	36.55	
111	 32 10 32 6° 10	8	1.02	4	4.08	
112	 80	8	0.80	40	32.00	
113	 28 12 28 6° 12	8	0.98	2	1.96	
114	 27 12 27 6° 12	8	0.96	2	1.92	
115	 27 10 27 6° 10	8	0.92	1	0.92	
116	 24 12 24 6° 12	8	0.90	8	7.20	
117	 22 12 22 6° 12	8	0.86	2	1.72	

ISKAZ ARMATURE	
GRAĐEVINA:	TERME TUHELJ- SMJEŠTAJNI PAVILJON
ISKAZ UZ NACRT:	ARM_E-1_605-611
SADRŽAJ:	NACRT SAVIJANJA ARMATURE ZIDOVA
DATUM:	Svibanj, 2023. 9/34

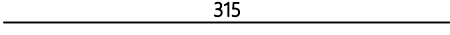
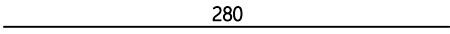
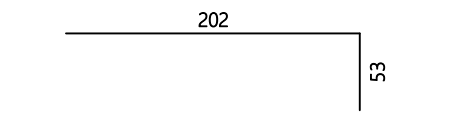
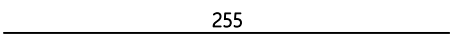
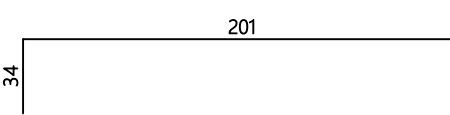
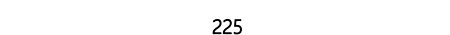
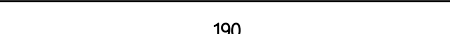
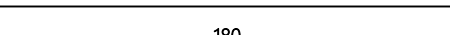
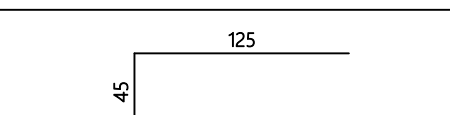
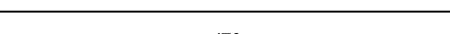
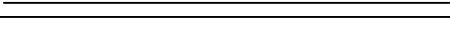
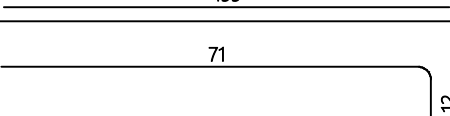
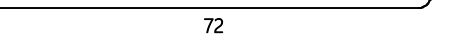
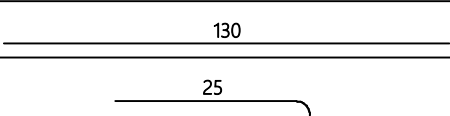

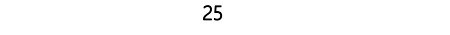
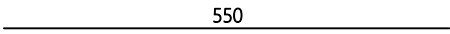
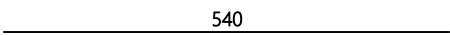
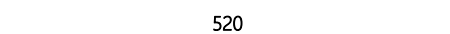
Šipke - specifikacija						
ozn	oblik i mjere [cm]	Ø	lg [m]	n [kom]	lgn [m]	Napomena
118		8	0.82	6	4.92	
119		8	0.80	2	1.60	
120		8	0.76	2	1.52	
121		8	0.74	2	1.48	
122		8	0.60	6	3.60	
123		8	0.30	884	265.20	
Prizemlje (1 kom)						
201		16	5.45	4	21.80	
202		16	3.95	8	31.60	
203		16	2.25	4	9.00	
204		16	1.75	6	10.50	
205		14	5.50	28	154.00	
206		14	4.80	12	57.60	
207		14	4.70	8	37.60	
208		14	3.90	68	265.20	
209		14	3.85	204	785.40	
210		14	3.40	8	27.20	

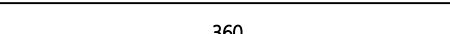
ISKAZ ARMATURE		
GRAĐEVINA:	TERME TUHELJ- SMJEŠTAJNI PAVILJON	
ISKAZ UZ NACRT:	ARM_E-1_605-611	
SADRŽAJ:	NACRT SAVIJANJA ARMATURE ZIDOVA	
DATUM:	Svibanj, 2023.	10/34

Šipke - specifikacija						
ozn	oblik i mjere [cm]	Ø	lg [m]	n [kom]	lgn [m]	Napomena
211		14	3.15	8	25.20	
212		14	2.80	24	67.20	
213		14	2.55	8	20.40	
214		14	2.55	8	20.40	
215		14	2.35	2	4.70	
216		14	2.25	24	54.00	
217		14	1.90	4	7.60	
218		14	1.80	4	7.20	
219		14	1.70	2	3.40	
220		14	1.70	2	3.40	
221		14	1.55	8	12.40	
222		14	1.55	8	12.40	
223		14	1.30	4	5.20	
224		10	0.60	327	196.20	
225		8	5.50	16	88.00	
226		8	5.40	2	10.80	
227		8	5.20	12	62.40	
228		8	4.70	4	18.80	
229		8	3.60	150	540.00	
230		8	3.55	20	71.00	
231		8	3.40	6	20.40	

ISKAZ ARMATURE

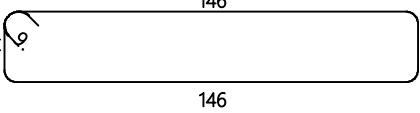
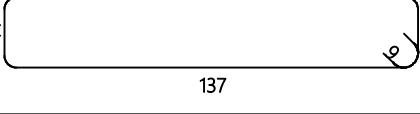
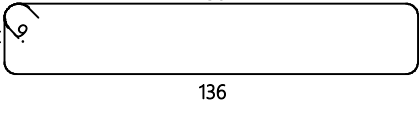
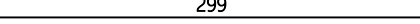
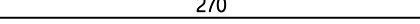
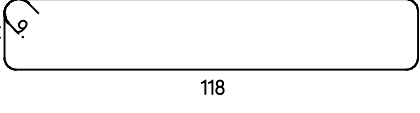
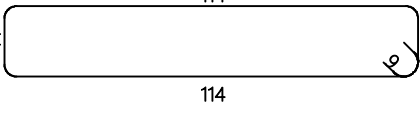
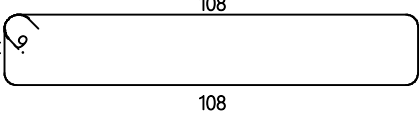
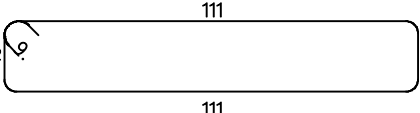

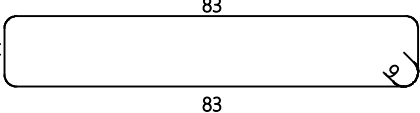
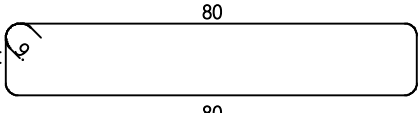
GRAĐEVINA:	TERME TUHELJ- SMJEŠTAJNI PAVILJON	
ISKAZ UZ NACRT:	ARM_E-1_605-611	
SADRŽAJ:	NACRT SAVIJANJA ARMATURE ZIDOVA	
DATUM:	Svibanj, 2023.	11/34

Šipke - specifikacija						
ozn	oblik i mjere [cm]	Ø	lg [m]	n [kom]	lgn [m]	Napomena
232		8	3.38	24	81.12	
233		8	3.20	32	102.40	
234		8	3.18	14	44.52	
235		8	2.99	28	83.72	
236		8	2.70	6	16.20	
237		8	2.82	84	236.88	
238		8	2.74	15	41.10	
239		8	2.62	16	41.92	
240		8	2.60	2	5.20	
241		8	2.00	16	32.00	
242		8	1.95	12	23.40	
243		8	2.12	16	33.92	
244		8	2.06	28	57.68	

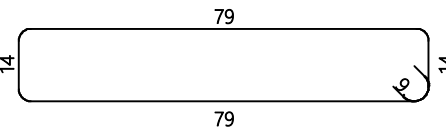
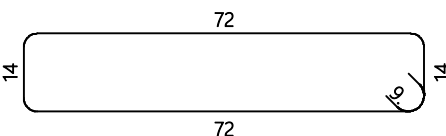
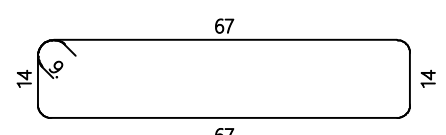
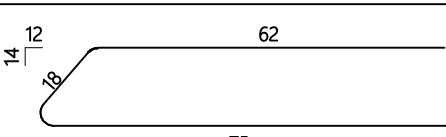
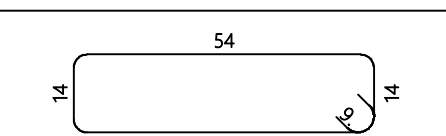
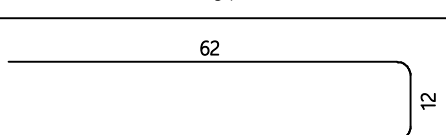
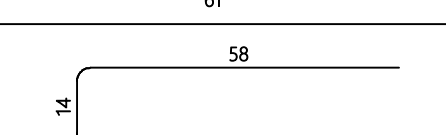
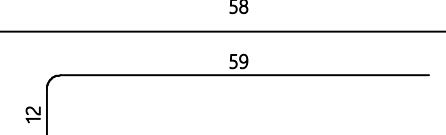
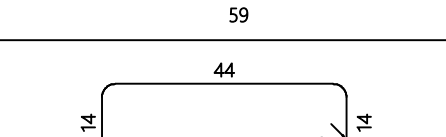
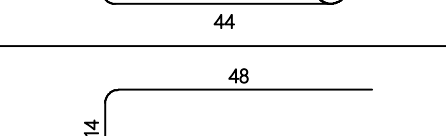

ISKAZ ARMATURE		
GRAĐEVINA:	TERME TUHELJ- SMJEŠTAJNI PAVILJON	
ISKAZ UZ NACRT:	ARM_E-1_605-611	
SADRŽAJ:	NACRT SAVIJANJA ARMATURE ZIDOVA	
DATUM:	Svibanj, 2023.	12/34

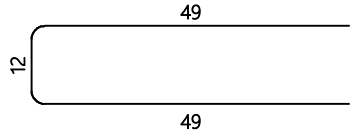
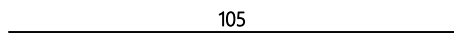
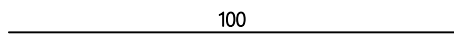
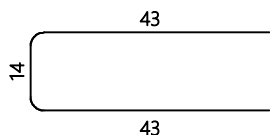
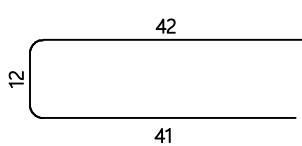
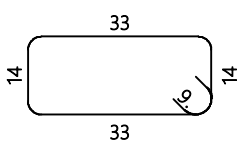
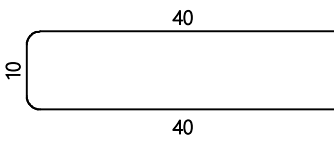
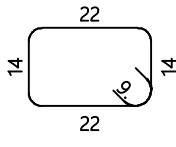
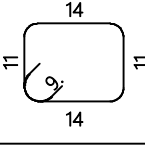
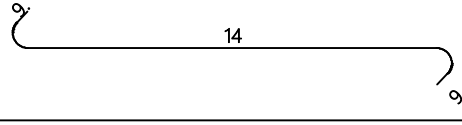
Šipke - specifikacija						
ozn	oblik i mjere [cm]	Ø	lg [m]	n [kom]	lgn [m]	Napomena
245		8	2.04	45	91.80	
246		8	1.90	20	38.00	
247		8	1.80	78	140.40	
248		8	1.55	38	58.90	
249		8	1.54	30	46.20	
250		8	1.35	200	270.00	
251		8	1.30	50	65.00	
252		8	1.30	342	444.60	
253		8	1.34	94	125.96	
254		8	1.10	46	50.60	

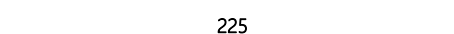
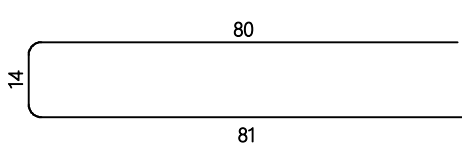



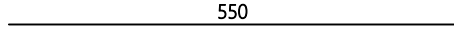
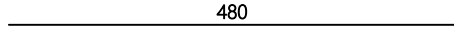
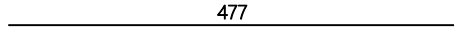
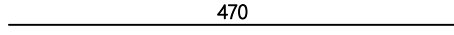
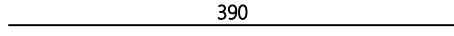
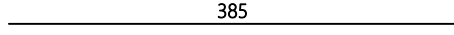
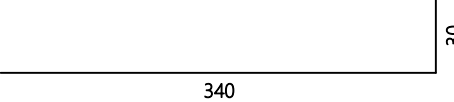
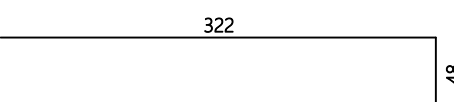
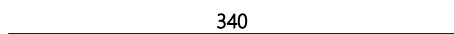
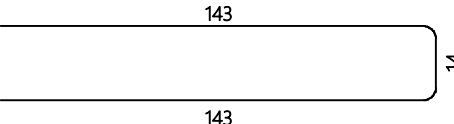
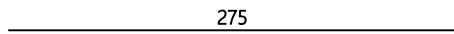
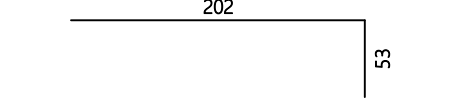
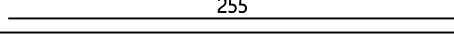
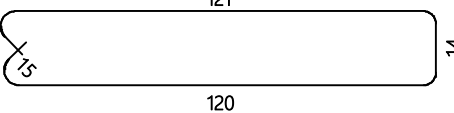

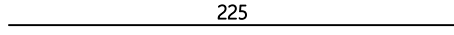
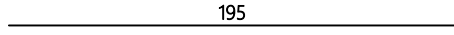
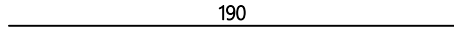
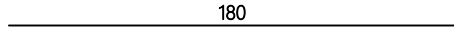
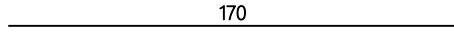
ISKAZ ARMATURE		
GRAĐEVINA:	TERME TUHELJ- SMJEŠTAJNI PAVILJON	
ISKAZ UZ NACRT:	ARM_E-1_605-611	
SADRŽAJ:	NACRT SAVIJANJA ARMATURE ZIDOVA	
DATUM:	Svibanj, 2023.	13/34

Šipke - specifikacija						
ozn	oblik i mjere [cm]	Ø	lg [m]	n [kom]	lgn [m]	Napomena
255		8	1.10	25	27.50	
256		8	1.05	1256	1318.80	
257		8	1.00	78	78.00	
258		8	1.00	56	56.00	
259		8	0.95	180	171.00	
260		8	1.12	2	2.24	
261		8	0.90	2	1.80	
262		8	0.90	6	5.40	
263		8	0.68	4	2.72	
264		8	0.32	654	209.28	
1.kat (1 kom)						
301		16	5.45	4	21.80	
302		16	2.25	4	9.00	
303		16	1.75	8	14.00	

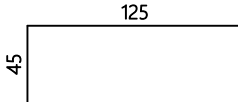
ISKAZ ARMATURE		
GRAĐEVINA:	TERME TUHELJ- SMJEŠTAJNI PAVILJON	
ISKAZ UZ NACRT:	ARM_E-1_605-611	
SADRŽAJ:	NACRT SAVIJANJA ARMATURE ZIDOVA	
DATUM:	Svibanj, 2023.	14/34

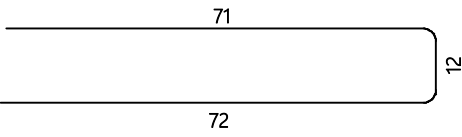
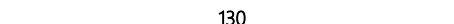
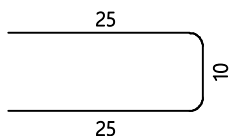
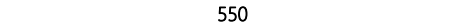
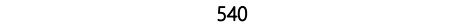
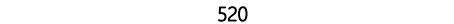
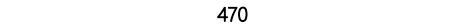
Šipke - specifikacija						
ozn	oblik i mjere [cm]	Ø	lg [m]	n [kom]	lgn [m]	Napomena
304		14	5.50	28	154.00	
305		14	4.80	12	57.60	
306		14	4.77	4	19.08	
307		14	4.70	8	37.60	
308		14	3.90	60	234.00	
309		14	3.85	196	754.60	
310		14	3.70	8	29.60	
311		14	3.70	8	29.60	
312		14	3.40	8	27.20	
313		14	3.00	4	12.00	
314		14	2.75	24	66.00	
315		14	2.55	8	20.40	
316		14	2.55	8	20.40	
317		14	2.85	2	5.70	
318		14	2.35	2	4.70	
319		14	2.25	24	54.00	
320		14	1.95	2	3.90	
321		14	1.90	12	22.80	
322		14	1.80	4	7.20	
323		14	1.70	2	3.40	

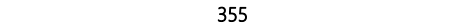
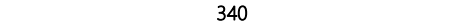
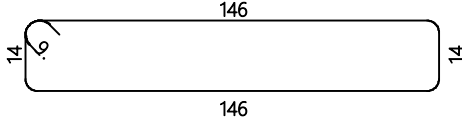
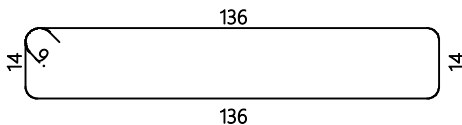
ISKAZ ARMATURE	
GRAĐEVINA:	TERME TUHELJ- SMJEŠTAJNI PAVILJON
ISKAZ UZ NACRT:	ARM_E-1_605-611
SADRŽAJ:	NACRT SAVIJANJA ARMATURE ZIDOVA
DATUM:	Svibanj, 2023. 15/34

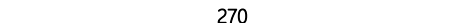
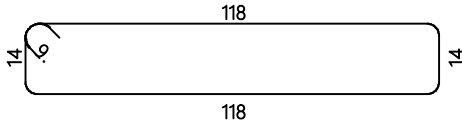
Šipke - specifikacija						
ozn	oblik i mjere [cm]	Ø	lg [m]	n [kom]	lgn [m]	Napomena
324		14	1.70	2	3.40	
325		14	1.55	8	12.40	
326		14	1.55	4	6.20	
327		14	1.30	4	5.20	
328		10	0.60	366	219.60	
329		8	5.50	16	88.00	
330		8	5.40	2	10.80	
331		8	5.20	12	62.40	
332		8	4.70	4	18.80	
333		8	3.60	128	460.80	
334		8	3.55	20	71.00	
335		8	3.40	6	20.40	
336		8	3.38	24	81.12	
337		8	3.18	14	44.52	
338		8	2.90	20	58.00	
339		8	2.70	6	16.20	
340		8	2.82	84	236.88	

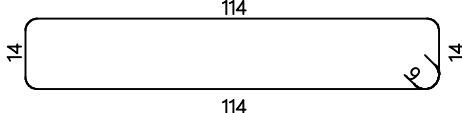
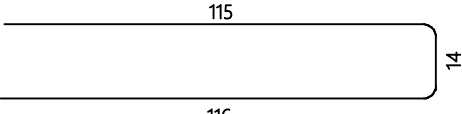
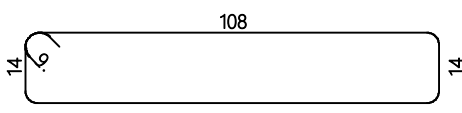
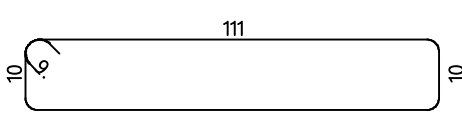
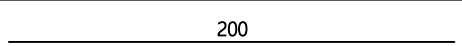
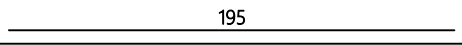
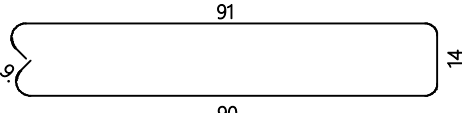
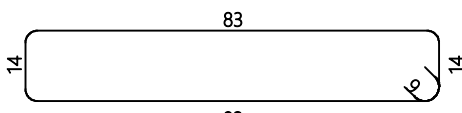
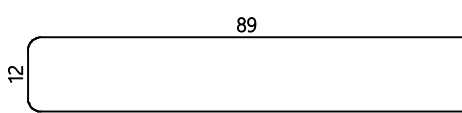
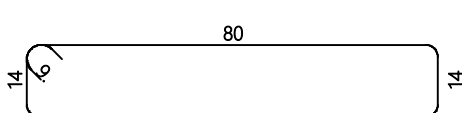
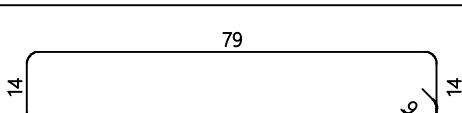

ISKAZ ARMATURE		
GRAĐEVINA:	TERME TUHELJ- SMJEŠTAJNI PAVILJON	
ISKAZ UZ NACRT:	ARM_E-1_605-611	
SADRŽAJ:	NACRT SAVIJANJA ARMATURE ZIDOVA	
DATUM:	Svibanj, 2023.	16/34

Šipke - specifikacija						
ozn	oblik i mjere [cm]	Ø	lg [m]	n [kom]	lgn [m]	Napomena
341		8	2.74	15	41.10	
342		8	2.45	14	34.30	
343		8	2.62	16	41.92	
344		8	2.60	2	5.20	
345		8	2.00	16	32.00	
346		8	1.95	12	23.40	
347		8	2.13	86	183.18	
348		8	2.12	16	33.92	
349		8	1.90	2	3.80	
350		8	2.06	28	57.68	
351		8	2.04	45	91.80	

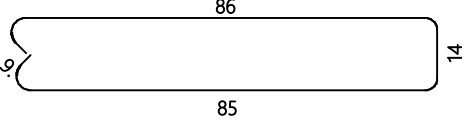
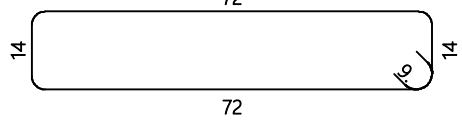
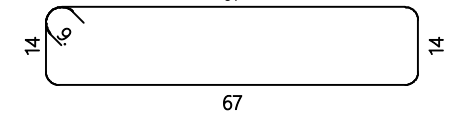
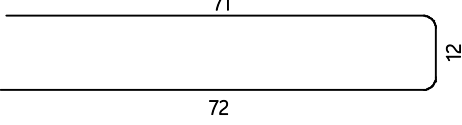
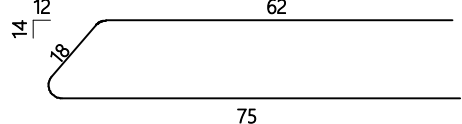
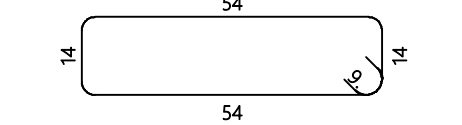
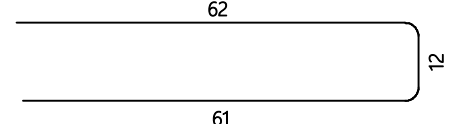
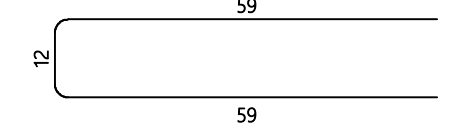
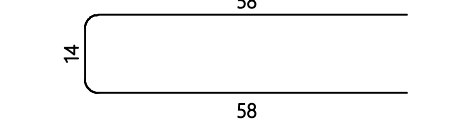
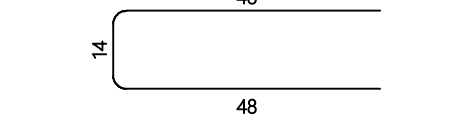
ISKAZ ARMATURE		
GRAĐEVINA:	TERME TUHELJ- SMJEŠTAJNI PAVILJON	
ISKAZ UZ NACRT:	ARM_E-1_605-611	
SADRŽAJ:	NACRT SAVIJANJA ARMATURE ZIDOVA	
DATUM:	Svibanj, 2023.	17/34

Šipke - specifikacija						
ozn	oblik i mjere [cm]	Ø	lg [m]	n [kom]	lgn [m]	Napomena
352		8	2.03	7	14.21	
353		8	1.90	20	38.00	
354		8	1.80	104	187.20	
355		8	1.55	6	9.30	
356		8	1.55	38	58.90	
357		8	1.54	30	46.20	
358		8	1.35	200	270.00	
359		8	1.30	214	278.20	
360		8	1.30	46	59.80	
361		8	1.10	46	50.60	

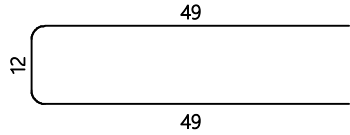
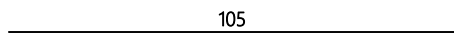
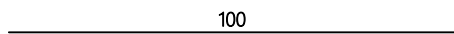
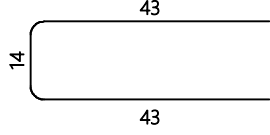
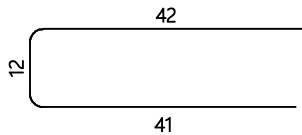
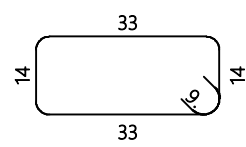
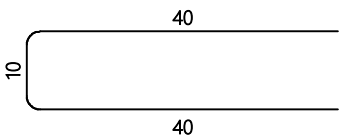
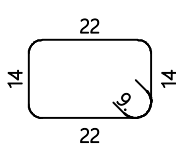
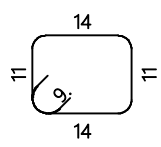
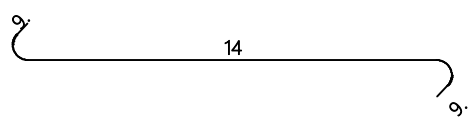
ISKAZ ARMATURE		
GRAĐEVINA:	TERME TUHELJ- SMJEŠTAJNI PAVILJON	
ISKAZ UZ NACRT:	ARM_E-1_605-611	
SADRŽAJ:	NACRT SAVIJANJA ARMATURE ZIDOVA	
DATUM:	Svibanj, 2023.	18/34

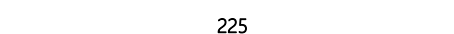
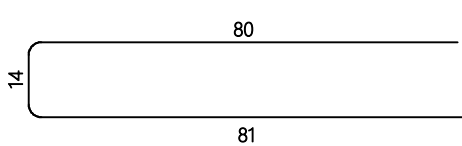
Šipke - specifikacija						
ozn	oblik i mjere [cm]	Ø	lg [m]	n [kom]	lgn [m]	Napomena
362		8	1.10	25	27.50	
363		8	1.05	1286	1350.30	
364		8	1.00	114	114.00	
365		8	1.00	56	56.00	
366		8	0.95	199	189.05	
367		8	1.12	2	2.24	
368		8	0.90	2	1.80	
369		8	0.90	6	5.40	
370		8	0.68	4	2.72	
371		8	0.32	732	234.24	
2.kat (1 kom)						
401		16	5.45	4	21.80	
402		16	2.25	4	9.00	
403		16	1.75	6	10.50	

ISKAZ ARMATURE		
GRAĐEVINA:	TERME TUHELJ- SMJEŠTAJNI PAVILJON	
ISKAZ UZ NACRT:	ARM_E-1_605-611	
SADRŽAJ:	NACRT SAVIJANJA ARMATURE ZIDOVA	
DATUM:	Svibanj, 2023.	19/34

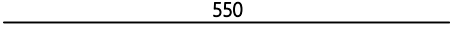
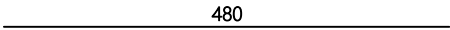
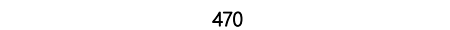
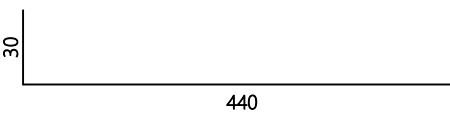
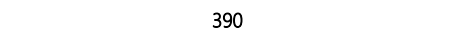
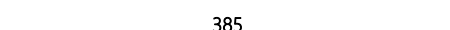
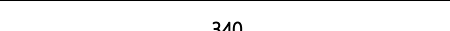
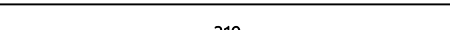
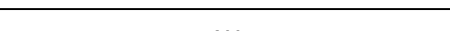
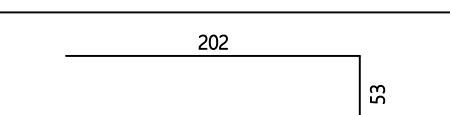
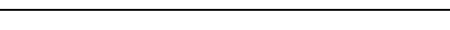
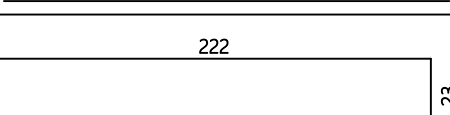
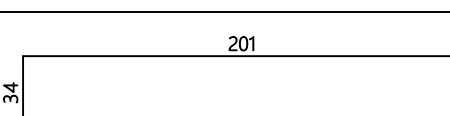
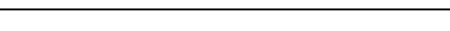
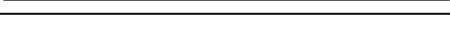
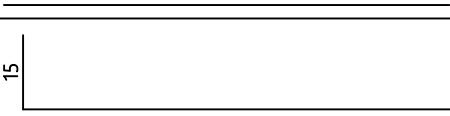
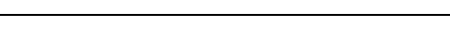
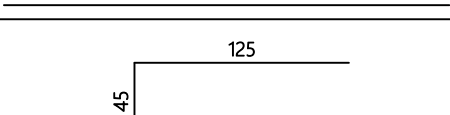
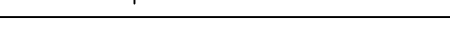
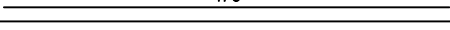
Šipke - specifikacija						
ozn	oblik i mjere [cm]	Ø	lg [m]	n [kom]	lgn [m]	Napomena
404	 550	14	5.50	16	88.00	
405	 480	14	4.80	8	38.40	
406	 470	14	4.70	8	37.60	
407	 30 440	14	4.70	14	65.80	
408	 390	14	3.90	60	234.00	
409	 385	14	3.85	208	800.80	
410	 340	14	3.40	6	20.40	
411	 310	14	3.10	8	24.80	
412	 280	14	2.80	12	33.60	
413	 202 53	14	2.55	8	20.40	
414	 255	14	2.55	10	25.50	
415	 222 23	14	2.45	6	14.70	
416	 34 201	14	2.35	2	4.70	
417	 225	14	2.25	24	54.00	
418	 190	14	1.90	8	15.20	
419	 15 175	14	1.90	14	26.60	
420	 180	14	1.80	4	7.20	
421	 45 125	14	1.70	2	3.40	
422	 170	14	1.70	2	3.40	
423	 155	14	1.55	8	12.40	

ISKAZ ARMATURE	
GRAĐEVINA:	TERME TUHELJ- SMJEŠTAJNI PAVILJON
ISKAZ UZ NACRT:	ARM_E-1_605-611
SADRŽAJ:	NACRT SAVIJANJA ARMATURE ZIDOVA
DATUM:	Svibanj, 2023.
	20/34

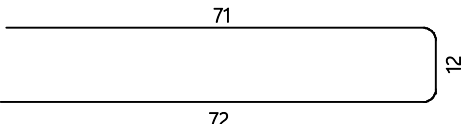
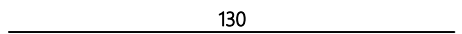
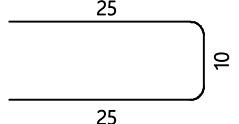
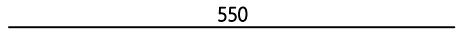
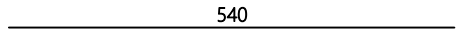
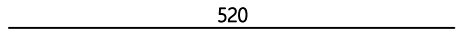
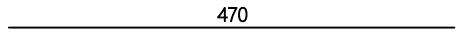
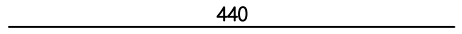
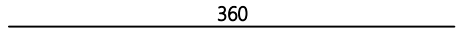
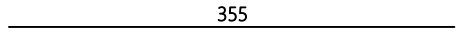
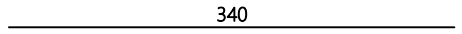
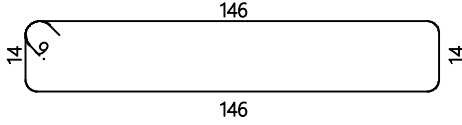
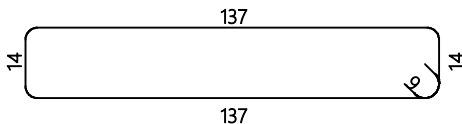
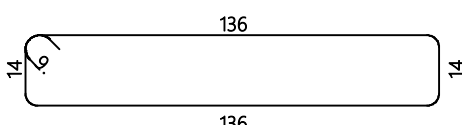
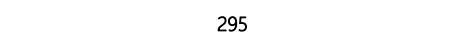
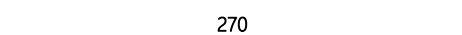
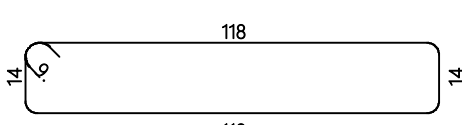

Šipke - specifikacija						
ozn	oblik i mjere [cm]	Ø	lg [m]	n [kom]	lgn [m]	Napomena
424		14	1.55	8	12.40	
425		14	1.30	4	5.20	
426		10	0.60	357	214.20	
427		8	5.50	10	55.00	
428		8	5.40	2	10.80	
429		8	5.20	12	62.40	
430		8	4.70	4	18.80	
431		8	4.40	6	26.40	
432		8	3.60	114	410.40	
433		8	3.55	20	71.00	
434		8	3.40	6	20.40	
435		8	3.38	12	40.56	
436		8	3.20	32	102.40	
437		8	3.18	14	44.52	
438		8	2.95	28	82.60	
439		8	2.70	3	8.10	
440		8	2.82	60	169.20	

ISKAZ ARMATURE

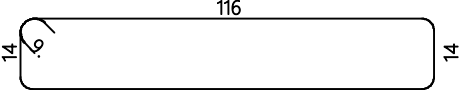
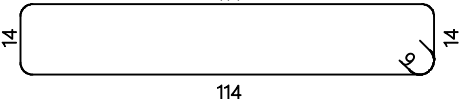
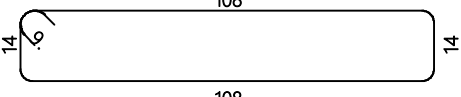
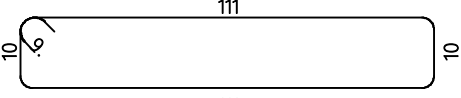
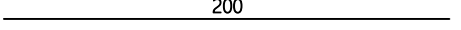
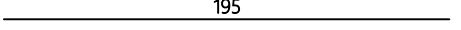
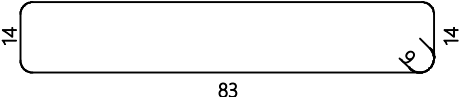
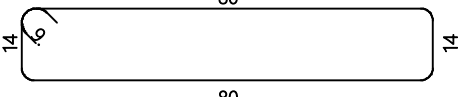
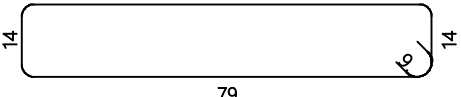
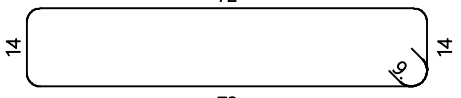
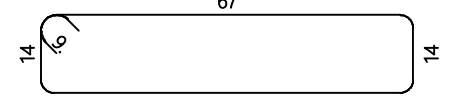
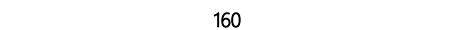
GRAĐEVINA:	TERME TUHELJ- SMJEŠTAJNI PAVILJON	
ISKAZ UZ NACRT:	ARM_E-1_605-611	
SADRŽAJ:	NACRT SAVIJANJA ARMATURE ZIDOVA	
DATUM:	Svibanj, 2023.	21/34

Šipke - specifikacija						
ozn	oblik i mjere [cm]	Ø	lg [m]	n [kom]	lgn [m]	Napomena
441		8	2.78	12	33.36	
442		8	2.74	15	41.10	
443		8	2.62	16	41.92	
444		8	2.60	2	5.20	
445		8	2.00	16	32.00	
446		8	1.95	12	23.40	
447		8	2.12	16	33.92	
448		8	2.06	14	28.84	
449		8	2.04	44	89.76	
450		8	1.90	20	38.00	
451		8	1.80	104	187.20	
452		8	1.60	8	12.80	

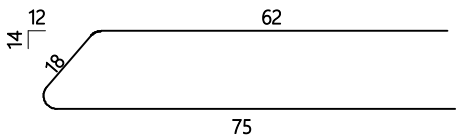
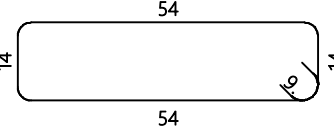

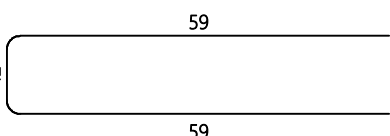
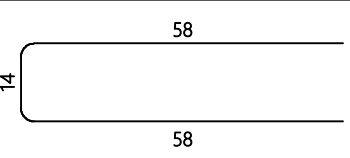
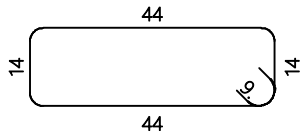
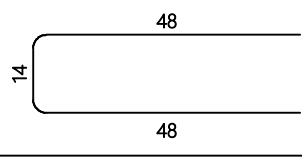
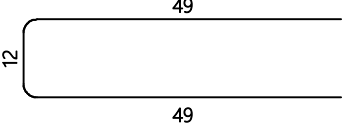
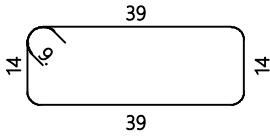
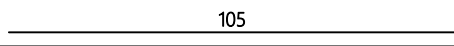
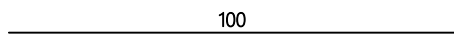
ISKAZ ARMATURE		
GRAĐEVINA:	TERME TUHELJ- SMJEŠTAJNI PAVILJON	
ISKAZ UZ NACRT:	ARM_E-1_605-611	
SADRŽAJ:	NACRT SAVIJANJA ARMATURE ZIDOVA	
DATUM:	Svibanj, 2023.	22/34

Šipke - specifikacija						
ozn	oblik i mjere [cm]	Ø	lg [m]	n [kom]	lgn [m]	Napomena
453		8	1.55	38	58.90	
454		8	1.54	37	56.98	
455		8	1.35	200	270.00	
456		8	1.30	270	351.00	
457		8	1.30	38	49.40	
458		8	1.34	79	105.86	
459		8	1.10	46	50.60	
460		8	1.10	25	27.50	
461		8	1.24	12	14.88	
462		8	1.05	1336	1402.80	
463		8	1.00	114	114.00	

ISKAZ ARMATURE

GRAĐEVINA:	TERME TUHELJ- SMJEŠTAJNI PAVILJON	
ISKAZ UZ NACRT:	ARM_E-1_605-611	
SADRŽAJ:	NACRT SAVIJANJA ARMATURE ZIDOVA	
DATUM:	Svibanj, 2023.	23/34

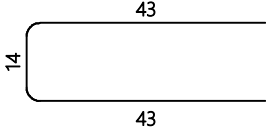
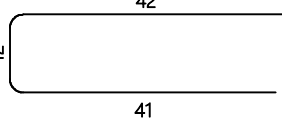
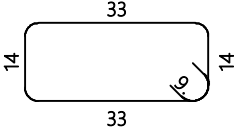
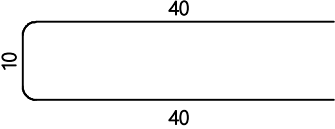
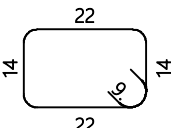
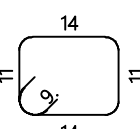
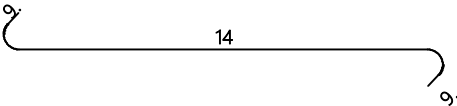
Šipke - specifikacija

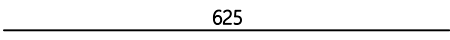
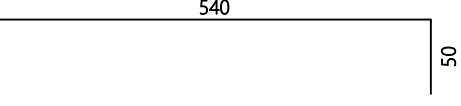
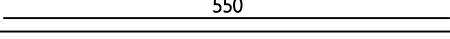
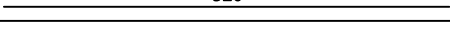
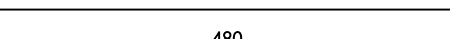
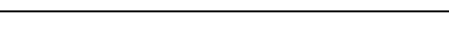
ozn	oblik i mjere [cm]	Ø	lg [m]	n [kom]	lgn [m]	Napomena
464		8	1.00	74	74.00	
465		8	0.95	160	152.00	
466		8	1.12	12	13.44	
467		8	0.90	2	1.80	
468		8	0.90	6	5.40	
469		8	0.68	4	2.72	
470		8	0.32	714	228.48	
3.kat (1 kom)						
501		14	10.90	4	43.60	
502		14	6.25	4	25.00	
503		14	5.90	4	23.60	
504		14	5.50	36	198.00	
505		14	5.20	16	83.20	
506		14	5.15	2	10.30	
507		14	4.80	8	38.40	

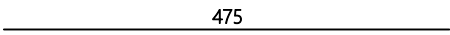
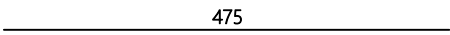
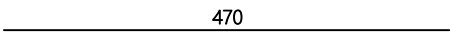
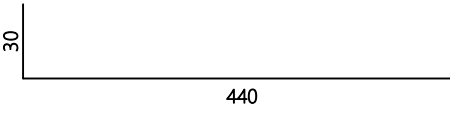
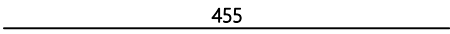
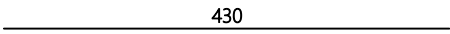
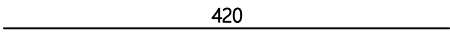
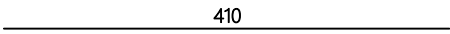
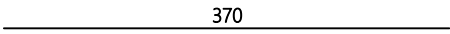
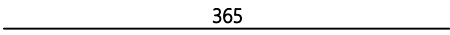
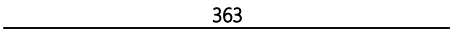
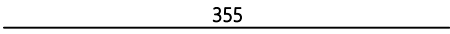
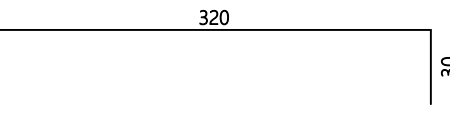
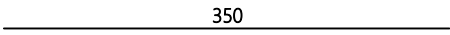
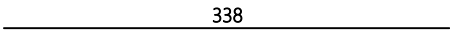
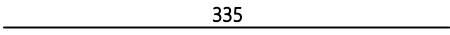
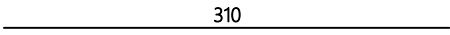
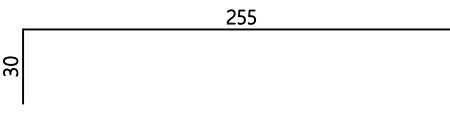
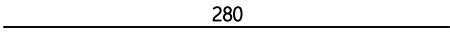
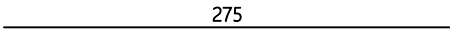
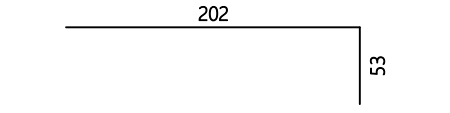
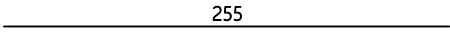
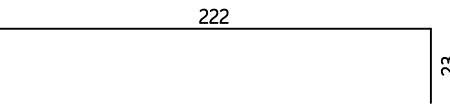

ISKAZ ARMATURE		
GRAĐEVINA:	TERME TUHELJ- SMJEŠTAJNI PAVILJON	
ISKAZ UZ NACRT:	ARM_E-1_605-611	
SADRŽAJ:	NACRT SAVIJANJA ARMATURE ZIDOVA	
DATUM:	Svibanj, 2023.	24/34

Šipke - specifikacija						
ozn	oblik i mjere [cm]	Ø	lg [m]	n [kom]	lgn [m]	Napomena
508	 475	14	4.75	16	76.00	
509	 475	14	4.75	20	95.00	
510	 470	14	4.70	4	18.80	
511	 30 440	14	4.70	14	65.80	
512	 455	14	4.55	16	72.80	
513	 430	14	4.30	4	17.20	
514	 420	14	4.20	4	16.80	
515	 410	14	4.10	12	49.20	
516	 370	14	3.70	8	29.60	
517	 365	14	3.65	44	160.60	
518	 363	14	3.63	16	58.08	
519	 355	14	3.55	28	99.40	
520	 320 30	14	3.50	4	14.00	
521	 350	14	3.50	20	70.00	
522	 338	14	3.38	8	27.04	
523	 335	14	3.35	28	93.80	
524	 310	14	3.10	16	49.60	
525	 30 255	14	2.85	4	11.40	
526	 280	14	2.80	16	44.80	
527	 275	14	2.75	4	11.00	
528	 202 53	14	2.55	8	20.40	
529	 255	14	2.55	10	25.50	
530	 222 23	14	2.45	6	14.70	

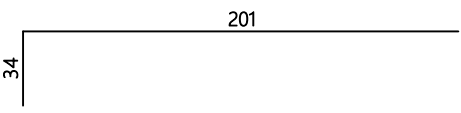
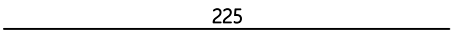
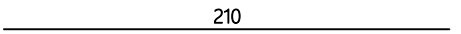
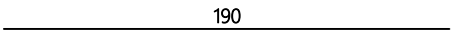
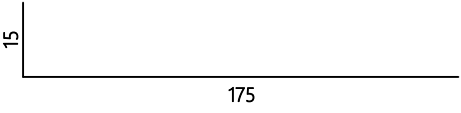
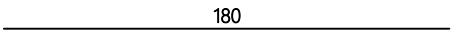
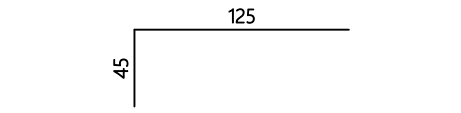
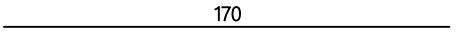
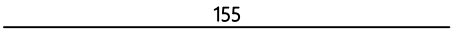
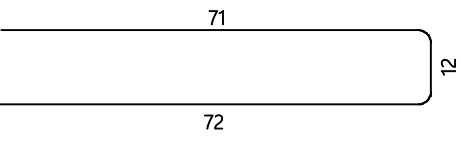
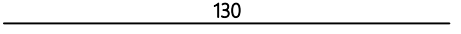
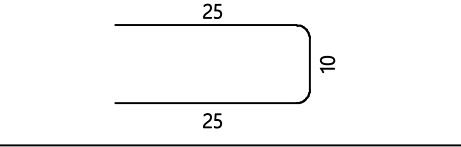
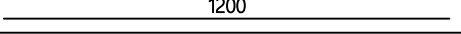
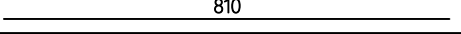
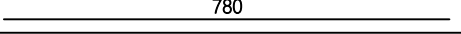
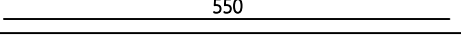
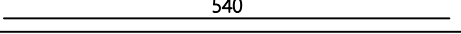
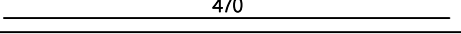
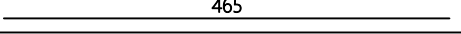
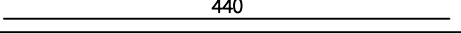
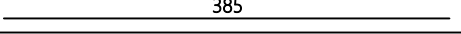
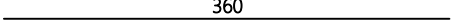
ISKAZ ARMATURE		
GRAĐEVINA:	TERME TUHELJ- SMJEŠTAJNI PAVILJON	
ISKAZ UZ NACRT:	ARM_E-1_605-611	
SADRŽAJ:	NACRT SAVIJANJA ARMATURE ZIDOVA	
DATUM:	Svibanj, 2023.	25/34

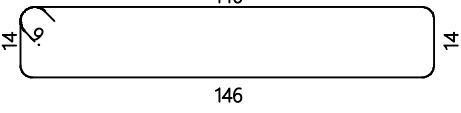
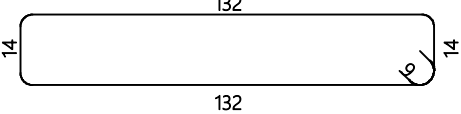
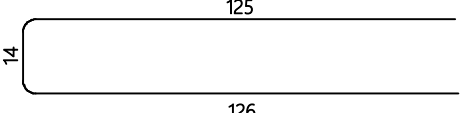
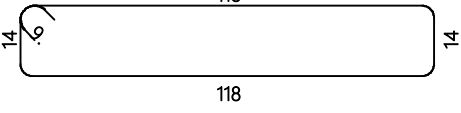
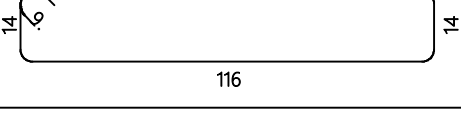

Šipke - specifikacija						
ozn	oblik i mjere [cm]	Ø	lg [m]	n [kom]	lgn [m]	Napomena
531		14	2.35	2	4.70	
532		14	2.25	28	63.00	
533		14	2.10	40	84.00	
534		14	1.90	4	7.60	
535		14	1.90	14	26.60	
536		14	1.80	4	7.20	
537		14	1.70	12	20.40	
538		14	1.70	64	108.80	
539		14	1.55	8	12.40	
540		14	1.55	74	114.70	
541		14	1.30	4	5.20	
542		10	0.60	554	332.40	
543		8	12.00	24	288.00	
544		8	8.10	24	194.40	
545		8	7.80	24	187.20	
546		8	5.50	34	187.00	
547		8	5.40	2	10.80	
548		8	4.70	4	18.80	
549		8	4.65	20	93.00	
550		8	4.40	6	26.40	
551		8	3.85	8	30.80	
552		8	3.60	6	21.60	

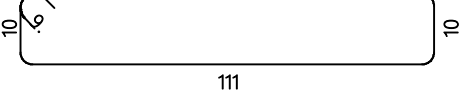
ISKAZ ARMATURE		
GRAĐEVINA:	TERME TUHELJ- SMJEŠTAJNI PAVILJON	
ISKAZ UZ NACRT:	ARM_E-1_605-611	
SADRŽAJ:	NACRT SAVIJANJA ARMATURE ZIDOVA	
DATUM:	Svibanj, 2023.	26/34

Šipke - specifikacija						
ozn	oblik i mjere [cm]	Ø	lg [m]	n [kom]	lgn [m]	Napomena
553	345	8	3.45	20	69.00	
554	340	8	3.40	24	81.60	
555	335	8	3.35	6	20.10	
556	330	8	3.30	12	39.60	
557	320	8	3.20	30	96.00	
558	 146	8	3.38	12	40.56	
559	310	8	3.10	32	99.20	
560	305	8	3.05	6	18.30	
561	 132	8	3.10	7	21.70	
562	275	8	2.75	134	368.50	
563	270	8	2.70	3	8.10	
564	 126	8	2.65	12	31.80	
565	 118	8	2.82	60	169.20	
566	 116	8	2.78	12	33.36	
567	 114	8	2.74	15	41.10	
568	245	8	2.45	134	328.30	
569	 111	8	2.60	2	5.20	

ISKAZ ARMATURE

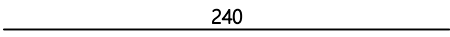
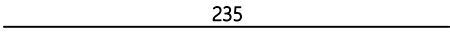
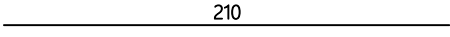
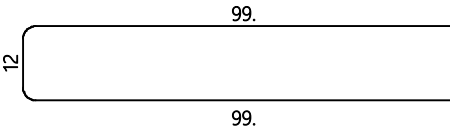
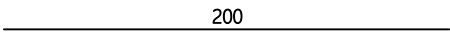
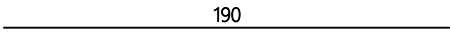
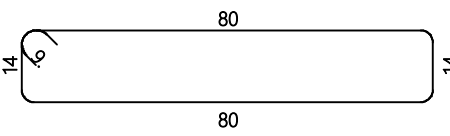
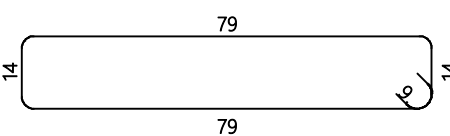
GRAĐEVINA:	TERME TUHELJ- SMJEŠTAJNI PAVILJON	
ISKAZ UZ NACRT:	ARM_E-1_605-611	
SADRŽAJ:	NACRT SAVIJANJA ARMATURE ZIDOVA	
DATUM:	Svibanj, 2023.	27/34

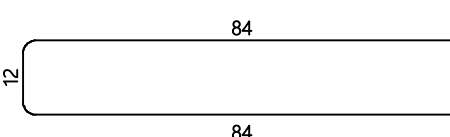
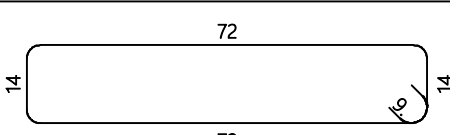
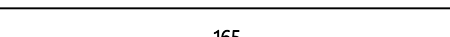
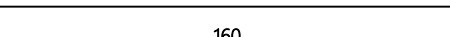
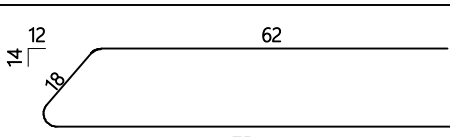
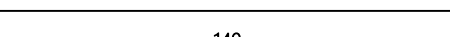
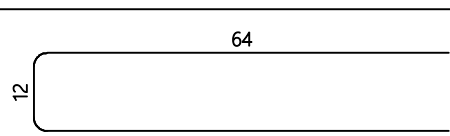
Šipke - specifikacija						
ozn	oblik i mjere [cm]	Ø	lg [m]	n [kom]	lgn [m]	Napomena
570		8	2.40	6	14.40	
571		8	2.35	32	75.20	
572		8	2.10	14	29.40	
573		8	2.10	19	39.90	
574		8	2.00	16	32.00	
575		8	1.90	48	91.20	
576		8	2.06	14	28.84	
577		8	2.04	44	89.76	
578		8	1.80	6	10.80	
579		8	1.80	4	7.20	
580		8	1.90	20	38.00	
581		8	1.65	6	9.90	
582		8	1.60	8	12.80	
583		8	1.55	66	102.30	
584		8	1.40	8	11.20	
585		8	1.40	1104	1545.60	

ISKAZ ARMATURE		
GRAĐEVINA:	TERME TUHELJ- SMJEŠTAJNI PAVILJON	
ISKAZ UZ NACRT:	ARM_E-1_605-611	
SADRŽAJ:	NACRT SAVIJANJA ARMATURE ZIDOVA	
DATUM:	Svibanj, 2023.	28/34

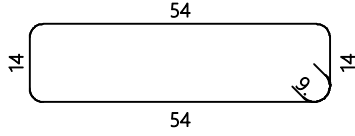
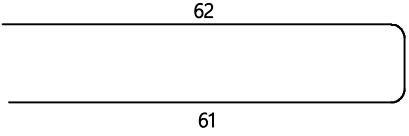
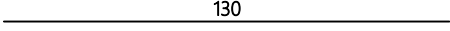
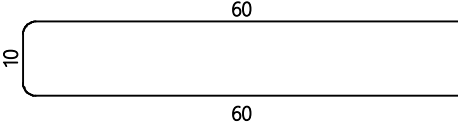
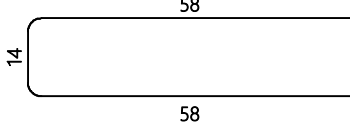
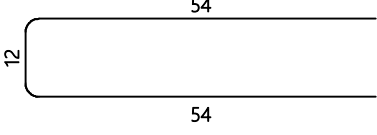
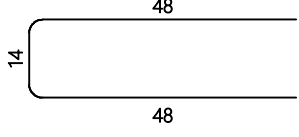
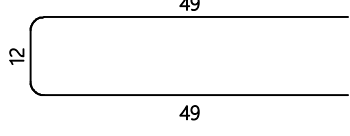
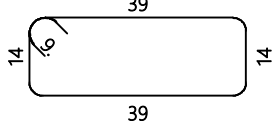
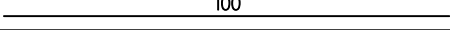
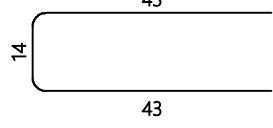
Šipke - specifikacija						
ozn	oblik i mjere [cm]	Ø	lg [m]	n [kom]	lgn [m]	Napomena
586		8	1.54	30	46.20	
587		8	1.35	545	735.75	
588		8	1.30	24	31.20	
589		8	1.30	14	18.20	
590		8	1.30	72	93.60	
591		8	1.20	4	4.80	
592		8	1.10	46	50.60	
593		8	1.10	48	52.80	
594		8	1.24	12	14.88	
595		8	1.00	230	230.00	
596		8	1.00	252	252.00	

ISKAZ ARMATURE

GRAĐEVINA:	TERME TUHELJ- SMJEŠTAJNI PAVILJON	
ISKAZ UZ NACRT:	ARM_E-1_605-611	
SADRŽAJ:	NACRT SAVIJANJA ARMATURE ZIDOVA	
DATUM:	Svibanj, 2023.	29/34

Šipke - specifikacija

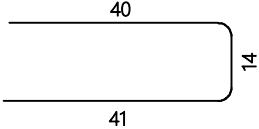
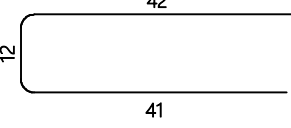
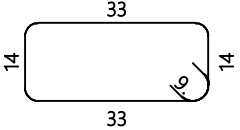
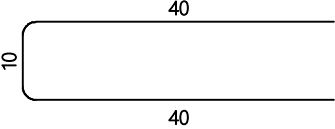
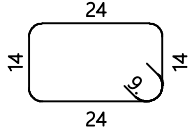
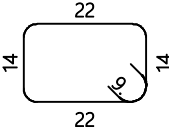
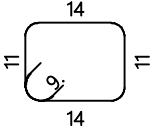
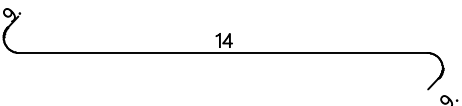
ozn	oblik i mjere [cm]	Ø	lg [m]	n [kom]	lgn [m]	Napomena
597		8	0.95	40	38.00	
598		8	0.95	222	210.90	
599		8	1.12	12	13.44	
600		8	0.90	2	1.80	
601		8	0.94	19	17.86	
602		8	0.90	2	1.80	
603		8	0.68	4	2.72	
604		8	0.32	1108	354.56	

ISKAZ ARMATURE		
GRAĐEVINA:	TERME TUHELJ- SMJEŠTAJNI PAVILJON	
ISKAZ UZ NACRT:	ARM_E-1_605-611	
SADRŽAJ:	NACRT SAVIJANJA ARMATURE ZIDOVA	
DATUM:	Svibanj, 2023.	30/34

Šipke - rekapitulacija			
Ø [mm]	lgn [m]	Jedinična težina [kg/m']	Težina [kg]
B500B			
8	26699.89	0.40	10546.46
10	1227.60	0.62	757.43
14	8681.09	1.21	10504.12
16	207.00	1.58	327.06
Ukupno (B500B)			22135.06
Ukupno			22135.06

ISKAZ ARMATURE		
GRAĐEVINA:	TERME TUHELJ- SMJEŠTAJNI PAVILJON	
ISKAZ UZ NACRT:	ARM_E-1_605-611	
SADRŽAJ:	NACRT SAVIJANJA ARMATURE ZIDOVA	
DATUM:	Svibanj, 2023.	31/34

Mreže - specifikacija							
Pozicija	Oznaka mreže	B [cm]	L [cm]	n	Jedinična težina [kg/m ²]	Ukupna težina [kg]	Napomena
Suteren (1 kom)							
1-1	Q-335	215	305	52	5.38	1834.53	
1-2	Q-335	90	305	10	5.38	147.68	
1-3	Q-335	199	299	2	5.38	64.02	
1-4	Q-335	215	299	40	5.38	1383.41	
1-5	Q-335	193	299	2	5.38	62.09	
1-6	Q-335	78	299	2	5.38	25.09	
1-7	Q-335	182	299	2	5.38	58.55	
1-8	Q-335	181	299	2	5.38	58.23	
1-9	Q-335	210	299	2	5.38	67.56	
1-10	Q-335	96	305	2	5.38	31.51	
1-11	Q-335	100	305	2	5.38	32.82	
1-12	Q-335	204	299	2	5.38	65.63	
1-13	Q-335	170	324	4	5.38	118.53	
1-14	Q-335	127	324	4	5.38	88.55	
1-15	Q-335	90	299	2	5.38	28.96	
1-16	Q-335	156	305	2	5.38	51.13	
1-17	Q-335	150	305	2	5.38	49.23	
1-18	Q-335	210	305	6	5.38	206.75	
1-19	Q-335	151	299	2	5.38	48.58	
1-20	Q-335	166	299	2	5.38	53.41	
1-21	Q-335	123	299	2	5.38	39.57	
1-22	Q-335	215	324	2	5.38	74.95	
1-23	Q-335	210	324	2	5.38	73.21	
1-24	Q-335	149	299	2	5.38	47.94	
1-25	Q-335	56	305	2	5.38	18.38	
1-26	Q-335	211	305	2	5.38	69.25	
1-27	Q-335	60	305	2	5.38	19.69	
1-28	Q-335	195	299	2	5.38	62.74	
1-29	Q-335	155	299	2	5.38	49.87	
Ukupno						4931.86	
Prizemlje (1 kom)							
2-1	Q-335	215	299	18	5.38	622.54	
2-2	Q-335	215	299	2	5.38	69.17	
2-3	Q-335	197	299	2	5.38	63.38	
2-4	Q-335	210	293	6	5.38	198.62	
2-5	Q-335	150	293	2	5.38	47.29	

ISKAZ ARMATURE		
GRAĐEVINA:	TERME TUHELJ- SMJEŠTAJNI PAVILJON	
ISKAZ UZ NACRT:	ARM_E-1_605-611	
SADRŽAJ:	NACRT SAVIJANJA ARMATURE ZIDOVA	
DATUM:	Svibanj, 2023.	32/34

Mreže - specifikacija							
Pozicija	Oznaka mreže	B [cm]	L [cm]	n	Jedinična težina [kg/m ²]	Ukupna težina [kg]	Napomena
2-6	Q-335	215	293	4	5.38	135.56	
2-7	Q-335	215	293	2	5.38	67.78	
2-8	Q-335	197	293	2	5.38	62.11	
2-9	Q-335	215	293	28	5.38	948.96	
2-10	Q-335	203	293	2	5.38	64.00	
2-11	Q-335	204	299	2	5.38	65.63	
2-12	Q-335	205	299	2	5.38	65.95	
2-13	Q-335	117	293	2	5.38	36.89	
2-14	Q-335	210	299	4	5.38	135.12	
2-15	Q-335	184	299	4	5.38	118.39	
2-16	Q-335	212	293	4	5.38	133.67	
2-17	Q-335	215	293	12	5.38	406.70	
2-18	Q-335	72	293	2	5.38	22.72	
2-19	Q-335	80	293	2	5.38	25.22	
2-20	Q-335	215	301	10	5.38	348.17	
2-21	Q-335	90	293	10	5.38	141.87	
Ukupno						3779.74	
1.kat (1 kom)							
3-1	Q-335	215	293	12	5.38	406.69	
3-2	Q-335	215	293	4	5.38	135.56	
3-3	Q-335	197	293	4	5.38	124.22	
3-4	Q-335	210	293	2	5.38	66.21	
3-5	Q-335	210	293	4	5.38	132.41	
3-6	Q-335	215	293	8	5.38	271.13	
3-7	Q-335	100	293	2	5.38	31.53	
3-8	Q-335	215	293	24	5.38	813.39	
3-9	Q-335	134	293	2	5.38	42.25	
3-10	Q-335	210	293	4	5.38	132.41	
3-11	Q-335	184	293	4	5.38	116.02	
3-12	Q-335	212	293	4	5.38	133.67	
3-13	Q-335	215	293	12	5.38	406.70	
3-14	Q-335	72	293	2	5.38	22.72	
3-15	Q-335	80	293	2	5.38	25.22	
3-16	Q-335	215	299	18	5.38	622.54	
3-17	Q-335	215	301	2	5.38	69.63	
3-18	Q-335	90	293	10	5.38	141.87	
Ukupno						3694.16	

ISKAZ ARMATURE		
GRAĐEVINA:	TERME TUHELJ- SMJEŠTAJNI PAVILJON	
ISKAZ UZ NACRT:	ARM_E-1_605-611	
SADRŽAJ:	NACRT SAVIJANJA ARMATURE ZIDOVA	
DATUM:	Svibanj, 2023.	33/34

Mreže - specifikacija							
Pozicija	Oznaka mreže	B [cm]	L [cm]	n	Jedinična težina [kg/m ²]	Ukupna težina [kg]	Napomena
2.kat (1 kom)							
4-1	Q-335	212	293	4	5.38	133.67	
4-2	Q-335	215	293	12	5.38	406.70	
4-3	Q-335	80	293	2	5.38	25.22	
4-4	Q-335	72	293	2	5.38	22.72	
4-5	Q-335	184	293	4	5.38	116.02	
4-6	Q-335	210	293	4	5.38	132.41	
4-7	Q-335	215	293	28	5.38	948.96	
4-8	Q-335	134	293	2	5.38	42.25	
4-9	Q-335	215	293	10	5.38	338.91	
4-10	Q-335	205	293	4	5.38	129.26	
4-11	Q-335	100	293	2	5.38	31.53	
4-12	Q-335	214	293	2	5.38	67.47	
4-13	Q-335	215	293	8	5.38	271.13	
4-14	Q-335	215	293	4	5.38	135.56	
4-15	Q-335	197	293	4	5.38	124.22	
4-16	Q-335	210	293	6	5.38	198.62	
4-17	Q-335	215	299	14	5.38	484.19	
4-18	Q-335	215	301	2	5.38	69.63	
4-19	Q-335	90	293	10	5.38	141.87	
4-20	Q-335	215	298	4	5.38	137.88	
4-21	Q-335	84	293	2	5.38	26.48	
Ukupno						3984.69	
3.kat (1 kom)							
5-1	Q-335	215	503	4	5.38	232.92	
5-2	Q-335	215	455	2	5.38	105.20	
5-3	Q-335	215	406	2	5.38	93.94	
5-4	Q-335	197	357	2	5.38	75.76	
5-5	Q-335	150	393	2	5.38	63.37	
5-6	Q-335	210	458	6	5.38	310.78	
5-7	Q-335	150	344	4	5.38	111.02	
5-8	Q-335	215	455	2	5.38	105.20	
5-9	Q-335	197	406	2	5.38	86.07	
5-10	Q-335	215	301	16	5.38	556.58	
5-11	Q-335	100	301	2	5.38	32.36	
5-12	Q-335	215	349	4	5.38	161.70	
5-13	Q-335	100	349	2	5.38	37.60	

ISKAZ ARMATURE		
GRAĐEVINA:	TERME TUHELJ- SMJEŠTAJNI PAVILJON	
ISKAZ UZ NACRT:	ARM_E-1_605-611	
SADRŽAJ:	NACRT SAVIJANJA ARMATURE ZIDOVA	
DATUM:	Svibanj, 2023.	34/34

Mreže - specifikacija							
Pozicija	Oznaka mreže	B [cm]	L [cm]	n	Jedinična težina [kg/m ²]	Ukupna težina [kg]	Napomena
5-14	Q-335	210	398	4	5.38	179.96	
5-15	Q-335	184	443	4	5.38	175.41	
5-16	Q-335	215	234	4	5.38	108.40	
5-17	Q-335	215	502	16	5.38	929.58	
5-18	Q-335	168	502	2	5.38	90.82	
5-19	Q-335	178	502	2	5.38	96.20	
5-20	Q-335	215	550	8	5.38	509.13	
5-21	Q-335	215	505	6	5.38	350.58	
5-22	Q-335	215	454	6	5.38	315.14	
5-23	Q-335	215	409	6	5.38	283.87	
5-24	Q-335	90	364	6	5.38	105.74	
5-25	Q-335	215	507	2	5.38	117.32	
5-26	Q-335	215	454	2	5.38	105.05	
5-27	Q-335	215	409	2	5.38	94.62	
5-28	Q-335	90	364	2	5.38	35.25	
5-29	Q-335	215	544	2	5.38	125.88	
5-30	Q-335	215	499	2	5.38	115.46	
5-31	Q-335	215	454	2	5.38	105.04	
5-32	Q-335	215	409	2	5.38	94.62	
5-33	Q-335	90	364	2	5.38	35.25	
5-34	Q-335	215	549	2	5.38	127.01	
5-35	Q-335	215	549	2	5.38	127.01	
5-36	Q-335	84	544	2	5.38	49.17	
5-37	Q-335	210	544	2	5.38	122.96	
5-38	Q-335	102	544	2	5.38	59.72	
Ukupno						6431.67	

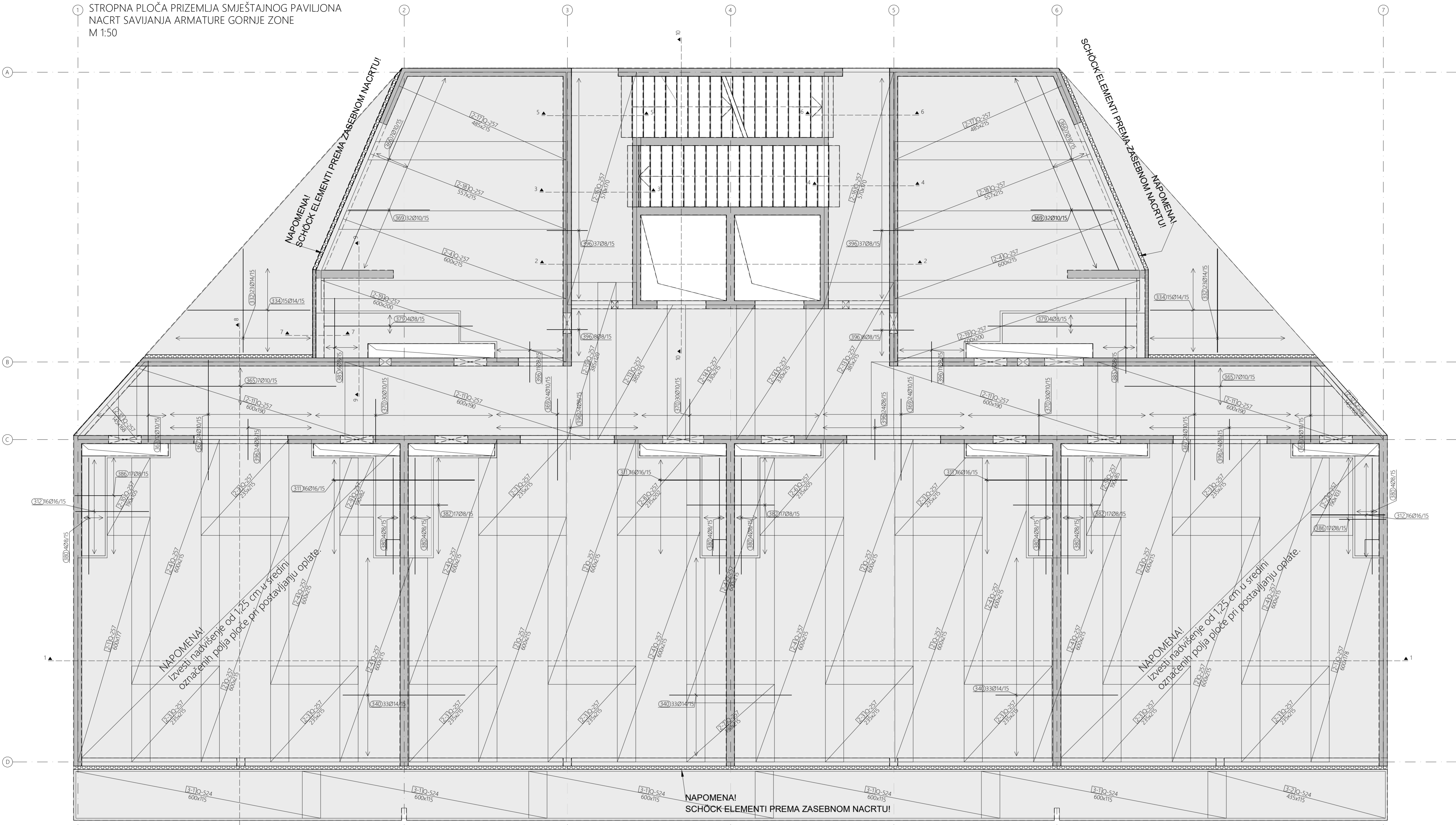

JAHAČI - 2 KOM / m²
PLOČA d=22 cm

JAHAČI - 2 KOM / m²
PLOČA d=20 cm

JAHAČI - 2 KOM / m²
PLOČA d=16 cm

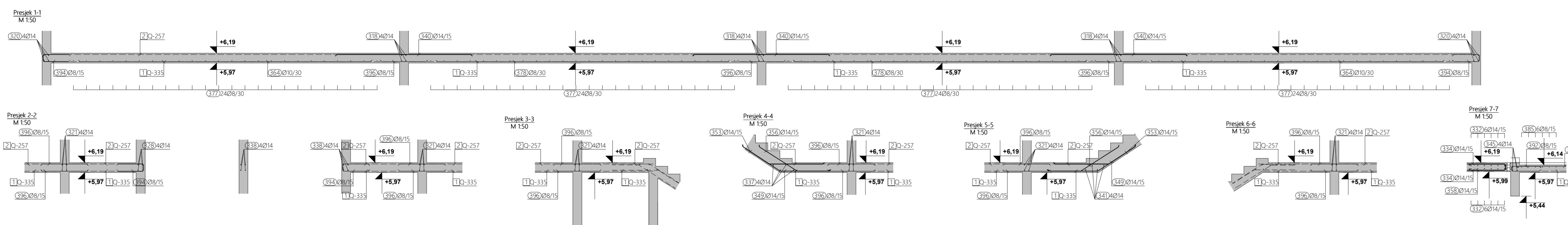

Šipke - specifikacija	oblik i mjere (cm)	l ⁰ (cm)	l ¹ (cm)	n (kom)	l ⁿ (cm)
Armatura stropne ploče prizemlja (1 kom)					
301	135	20	12,00	2	24,00
302	100 10 10 10	20	12,00	6	72,00
303	100 5 10 10 100	20	12,00	4	48,00
304	100 30 30 100	20	11,40	2	22,80
305	100 5 10 10 10	20	11,40	4	45,60
306	150	16	12,00	4	48,00
307	80 18 18 18 100	16	12,00	6	72,00
308	100 2 100	16	12,00	2	24,00
309	100 30 30 100	16	10,70	4	42,80
310	100	16	10,70	2	21,40
311	150	16	3,50	48	168,00
312	180	16	2,65	32	84,80
313	1200	14	12,00	18	216,00
314	1020	14	11,20	8	89,60
315	960	14	9,60	4	38,40
316	950	14	9,50	6	57,00
317	885	14	8,85	4	35,40
318	875	14	8,75	12	105,00
319	850	14	8,50	4	34,00
320	805	14	8,05	8	64,40
321	795	14	7,95	12	95,40
322	620	14	6,20	8	49,60
323	595	14	5,95	6	35,70
324	560	14	5,60	4	22,40
325	540	14	5,40	4	21,60
326	535	14	5,35	8	42,80
327	a	14	*2,94	2 x 12	70,48
328	a	14	4,85	8	38,80
329	a	14	*2,88	2 x 27	153,00
330	a	14	4,60	4	18,40
331	a	14	4,50	2	9,00
332	a	14	*2,54	4 x 23	234,04
333	a	14	4,20	8	33,60
334	a	14	*3,01	4 x 15	180,88
335	a	14	3,70	6	59,20
336	a	14	3,40	4	13,60
337	a	14	3,30	4	13,20
338	a	14	3,15	8	25,20
339	a	14	3,05	4	12,20
340	a	14	3,00	99	297,00
341	a	14	2,95	4	11,80
342	a	14	2,90	6	17,40
343	a	14	2,90	6	17,40
344	a	14	2,85	4	11,40
345	a	14	2,75	8	22,00

346	a	14	2,75	16	44,00
347	a	14	2,55	8	20,40
348	a	14	2,50	8	20,00
349	a	14	2,10	20	42,00
350	a	14	2,00	14	28,00
351	a	14	1,95	32	62,40
352	a	14	1,90	8	15,20
353	a	14	1,90	20	38,00
354	a	14	1,75	8	14,00
355	a	14	1,75	46	80,50
356	a	14	1,70	18	30,60
357	a	14	1,70	16	27,20
358	a	14	1,70	60	102,00
359	a	14	1,70	46	78,20
360	a	14	1,65	4	6,60
361	a	14	1,60	16	25,60
362	a	14	1,60	26	41,60
363	a	12	1,50	80	120,00
364	a	10	6,50	46	299,00
365	2 x	10	*5,10	2 x 7	71,36
366	a	10	5,17	14	72,38
367	a	10	2,95	48	141,60
368	a	10	2,75	24	66,00
369	a	10	2,00	352	704,00
370	a	10	1,80	90	162,00
371	a	10	1,50	208	312,00
372	a	10	1,40	32	44,80
373	a	10	1,30	30	39,00
374	a	10	1,20	432	518,40
375	a	8	12,00	12	144,00
376	a	8	8,90	6	53,40
377	a	8	6,70	96	643,20
378	a	8	6,50	46	299,00
379	a	8	3,65	8	29,20
380	a	8	2,85	32	91,20
381	a	8	2,25	30	67,50
382	a	8	2,15	51	109,65
383	a	8	2,15	6	12,90
384	a	8	1,90	26	49,40
385	a	8	1,85	12	22,20
386	a	8	1,85	34	62,90
387	a	8	1,80	208	374,40
388	a	8	1,50	24	36,00

389	a	8	1,50	18	27,00
390	a	8	1,45	70	101,50
391	a	8	1,40	64	89,60
392	a	8	1,35	16	21,60
393	a	8	1,30	406	527,80
394	a	8	1,30	280	364,00
395	a	8	1,30	6	79,30
396	a	8	1,00	624	624,00
397	a	8	1,00	6	6,00
398	a	8	0,99	760	752,40
399	a	8	0,91	128	116,48
400	a	8	0,87	34	29,38

NAPOMENA
Šipke prilagoditi i po potrebi reziati na licu mjesta. Preklap 50Z.

NAPOMENA
Sve dimenzije provjeriti prema važećim planovima oplate.

Klasa betona	C 25/30
Armatura	B 500 B
Zaštitni sloj betona	3,0 cm
dođe	gore
3,0 cm	bočno
3,0 cm	3,0 cm
Pripadajući isos armature: ARM_E0_601-603_1SKAZ	
Pripadajući armaturni nacrti: ARM_E0_601-603	

KONSTRUKTA PEČAT I POTPIS:
KONSTRUKTA d.o.o. za projektiranje i nadzor
 Desnička 20, ZAGREB, OIB: 06674378579
 ZR: PRIVREDNA BANKA 2340009-1110164468
 TEL: 01136 43 326; FAX: 01136 43 829
 MAIL: info@konstrukt.hr

INVESTITOR: TERME TUHELJI d.o.o. Ljudevita Gaja 4, Tuhejske Toplice, 49215 Tuhej
 GRADEVINA: REKONSTRUKCIJA TERMA I NOG-REKREACIJSKOG CENTRA TERME TUHELJI
 LOKACIJA: na k.č.br. 3199/1, k.o. Črešnjevec
 FAZA: IZVEDBENI PROJEKT - ARMATURNI NACRTI
 SADRŽAJ: ELEMENT - SMJEŠTAINI PAVILJON ARMATURA STR. PLOČE PRIZEMLIJA GORNJA ZONA

GL. PROJEKTANT: Tomislav Vrdel, dipl. ing. arh.
 PROJEKT. IZV. PR: Antonio Magjari, dipl. ing. grad.
 IZRADIO: Antonio Magjari, dipl. ing. grad.
 DATUM: srpanj 2023
 MJESECI: 150
 REVIZIJA: 09
 NACRT BR: ARM - E0 - 602

STROPNA PLOČA PRIZEMLJA SMEJŠTAINOG PAVILJONA
NACRT SAVIJANJA RUBNE ARMATURE I ANKERA
M 1:50

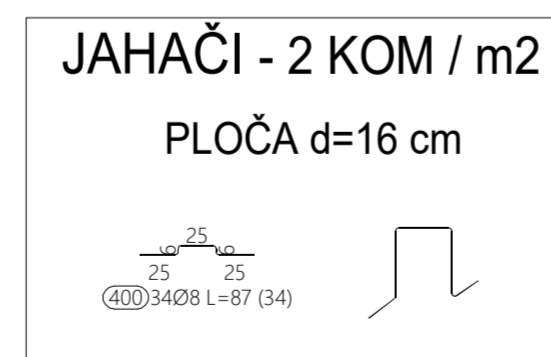
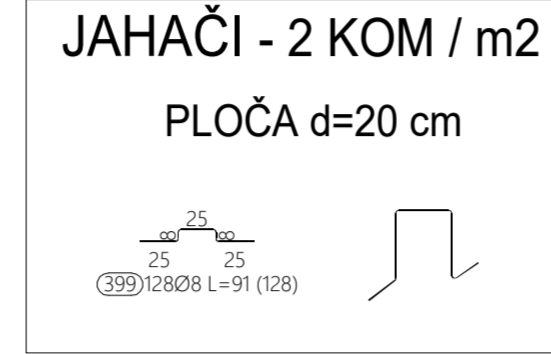
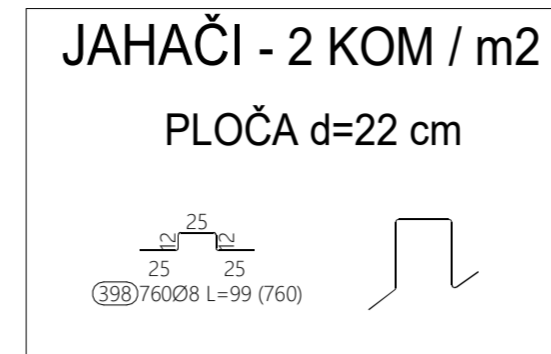
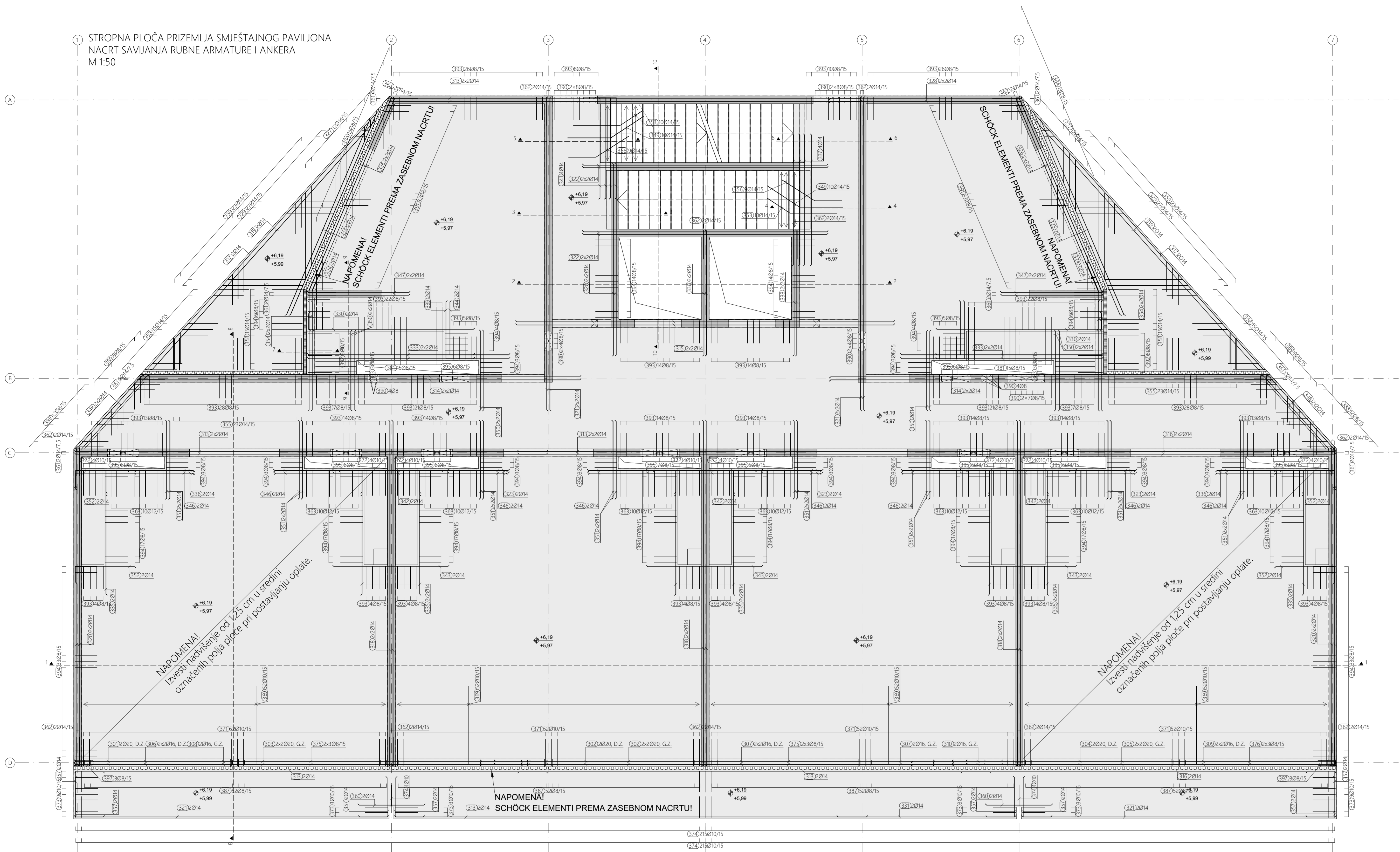

NAPOMENA!
Izvesti naklapanje od 125 cm u sredini
označenih polja plate pri postavljanju optate.

NAPOMENA!
Izvesti naklapanje od 125 cm u sredini
označenih polja plate pri postavljanju optate.

NAPOMENA!
SCHÖCK ELEMENTI PREMA ZASEBNOJ NACRTU!

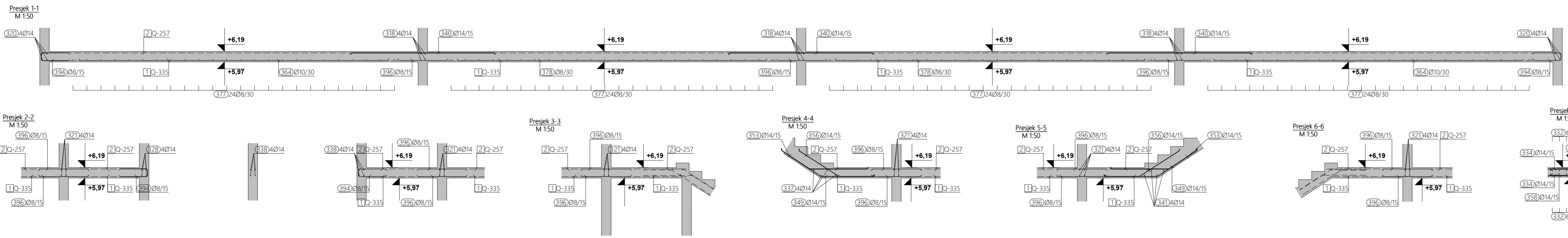

Šipke - specifikacija	oblik i mjere		l	l ₁	n	lgn
ozn	Šm	l ₂	[mm]	[mm]	[kom]	[mm]
Armatura stropne ploče prizemlja (1 kom)						
301	55	1195	20	1200	2	2400
302	100	1070	20	1200	6	7200
303	60	1005	20	1200	4	4800
304	100	945	20	1140	2	2280
305	55	1075	20	1140	4	4560
306	55	1150	16	1200	4	4800
307	80	1110	16	1200	6	7200
308	50	1052	16	1200	2	2400
309	80	1022	16	1070	4	4280
310	100	1020	16	1070	2	2140
311	350	1200	16	350	48	3600
312	165	1180	16	265	32	8480
313	180	1200	14	1200	18	21600
314	1100	14	1120	8	8960	
315	960	14	960	4	3840	
316	950	14	950	6	5700	
317	885	14	885	4	3540	
318	875	14	875	12	10500	
319	890	14	850	4	3400	
320	895	14	805	8	6440	
321	735	14	795	12	9540	
322	620	14	620	8	4960	
323	595	14	595	6	3570	
324	560	14	560	4	2240	
325	540	14	540	4	2160	
326	535	14	535	8	4280	
327	a	14	*2,94	2 x 12	70,48	
328	a	14	4,85	8	38,80	
329	a	14	*2,83	2 x 27	153,00	
330	a	14	2,07	34, 41, 48, 56, 63, 70, 77, 84, 91, 98, 106, 115, 120, 127, 134, 141, 148, 155, 163, 170, 177, 184, 191, 198, 205		
331	a	14	4,50	2	9,00	
332	a	14	*2,54	4 x 23	234,04	
333	a	14	4,20	8	33,60	
334	a	14	*3,01	4 x 15	180,88	
335	a	14	3,70	16	59,20	
336	a	14	3,40	4	13,60	
337	a	14	3,30	4	13,20	
338	a	14	3,15	8	25,20	
339	a	14	3,05	4	12,20	
340	a	14	3,00	99	297,00	
341	a	14	2,95	4	11,80	
342	a	14	2,90	6	17,40	
343	a	14	2,90	6	17,40	
344	a	14	2,85	4	11,40	
345	a	14	2,75	8	22,00	
346	a	14	2,75	16	44,00	
347	a	14	2,55	8	20,40	
348	a	14	2,50	8	20,00	
349	a	14	2,10	20	42,00	
350	a	14	2,00	14	28,00	
351	a	14	1,95	32	62,40	
352	a	14	1,90	8	15,20	
353	a	14	1,90	20	38,00	
354	a	14	1,75	8	14,00	
355	a	14	1,75	46	80,50	
356	a	14	1,70	18	30,60	
357	a	14	1,70	16	27,20	
358	a	14	1,70	60	102,00	
359	a	14	1,70	46	78,20	
360	a	14	1,65	4	6,60	
361	a	14	1,60	16	25,60	
362	a	14	1,60	26	41,60	
363	a	12	1,50	80	100,00	
364	a	10	6,50	46	299,00	
365	2 x	10	*5,10	2 x 7	71,36	
366	a	10	5,17	14	72,38	
367	a	10	2,95	48	141,60	
368	a	10	2,75	24	66,00	
369	a	10	2,00	352	704,00	
370	a	10	1,80	90	162,00	
371	a	10	1,50	208	312,00	
372	a	10	1,40	32	44,80	
373	a	10	1,30	30	39,00	
374	a	10	1,20	432	518,40	
375	a	8	10,00	10	144,00	
376	a	8	8,90	6	53,40	
377	a	8	6,70	96	643,20	
378	a	8	6,50	46	299,00	
379	a	8	3,65	8	29,20	
380	a	8	2,85	32	91,20	
381	a	8	2,25	30	67,50	
382	a	8	2,15	51	109,65	
383	a	8	2,15	6	12,90	
384	a	8	1,90	26	49,40	
385	a	8	1,85	12	22,20	
386	a	8	1,85	34	62,90	
387	a	8	1,80	208	374,40	
388	a	8	1,50	24	36,00	

NAPOMENA
Šipke prilagoditi i po potrebi rezi na licu mjesta. Preklap 50Z.

NAPOMENA
Sve dimenzije provjeriti prema važećim planovima optate.

Klasa betona	C 25/30
Armatura	B 500 B
Zaštiti sloj betona	Pripadajući sloj armature: ARM_E0_601-603_IŠKAZ
dijel	3,0 cm
gore	3,0 cm
bočno	3,0 cm
Pripadajući armaturni nacrti	ARM_E0_601-602

KONSTRUKTA PEČAT I POTPIŠ:
KONSTRUKTA d.o.o., za projektiranje i nadzor
Desinićka 20, ZAGREB, OIB: 06674376579
Zr: PRIVREDNA BANKA 2340009-1110164468
TEL: 01/36 43 826; FAX: 01/36 43 829
MAIL: info@konstrukt.hr

INVESTITOR: TERME TUHVELI d.o.o. Uspješni Gata 4, Tuhejske Toplice, 49275 Tuhej

GRAĐEVINA: REKONSTRUKCIJA TERMALNOG REKREACIJSKOG CENTRA TERME TUHVELI

LOKACIJA: na k.č.br. 3199/1, k.o. Črešnjevec

FAZA: IZVEDBENI PROJEKT - ARMATURNI NACRTI

SADRŽAJ: ELEMENT - SMEJŠTAINI PAVILJON ARMATURA STR. PLOČE PRIZEMLJA RUBNA ARMATURA I ANKERI

GL. PROJEKTANT: Tomislav Vrdić, dipl. ing. arh.

PROJEKT. IZV. PR: Antonio Maglov, dipl. ing. građ.

IZRADIO: Antonio Maglov, dipl. ing. građ.

DATUM: veljača 2023.

MJESECI: 150

REVIJUAL: 09

NACRT BR: **ARM - E0 - 603**



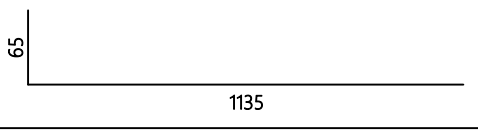
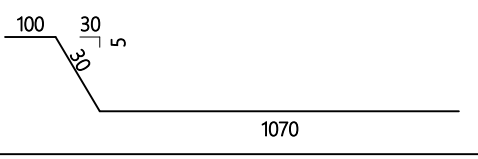
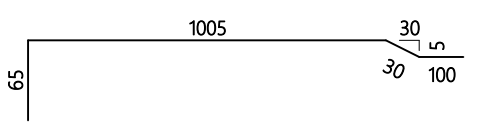
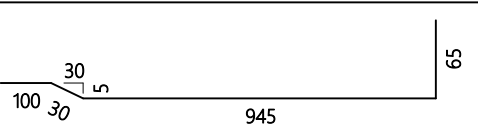
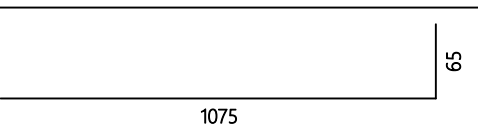
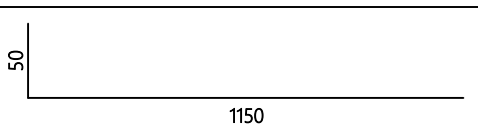
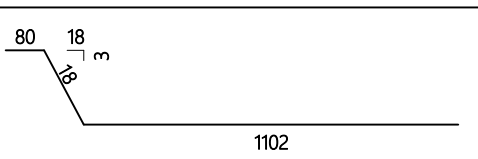
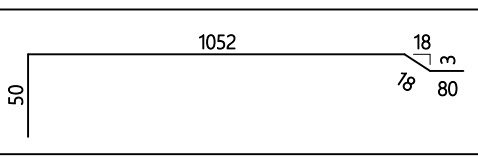
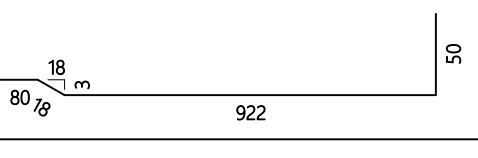
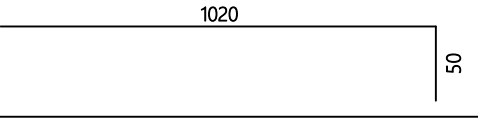
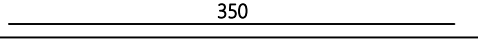
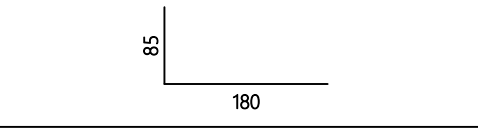
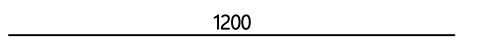

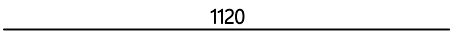
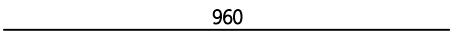
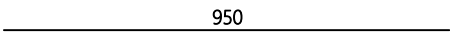
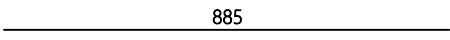
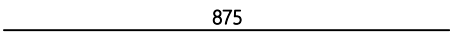
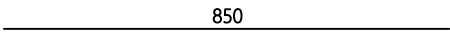
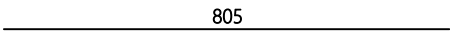
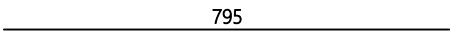
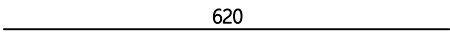
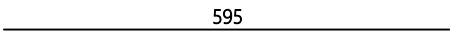
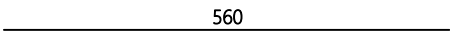
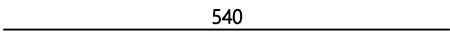
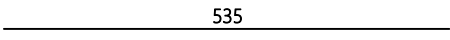
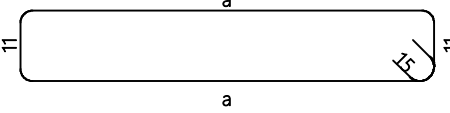
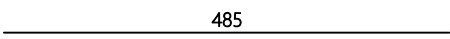
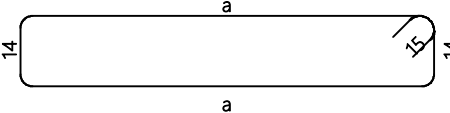
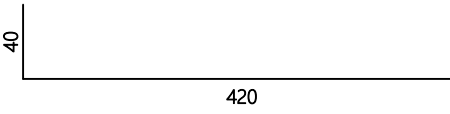
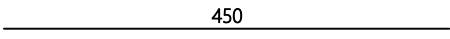
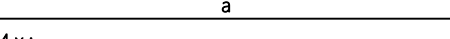
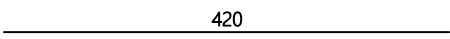

ISKAZ ARMATURE		
GRAĐEVINA:	REKONSTRUKCIJA TERMALNOG REKREACIJSKOG CENTRA TERME TUHELJ	
ISKAZ UZ NACRT:	ARM_E0_601-603_0	
SADRŽAJ:	ARMATURA STROPNE PLOČE PRIZEMLJA	
DATUM:	svibanj, 2023.	1/15

Šipke - specifikacija						
ozn	oblik i mjere [cm]	Ø	lg [m]	n [kom]	lgn [m]	Napomena
Armatura stropne ploče prizemlja (1 kom)						
301		20	12.00	2	24.00	
302		20	12.00	6	72.00	
303		20	12.00	4	48.00	
304		20	11.40	2	22.80	
305		20	11.40	4	45.60	
306		16	12.00	4	48.00	
307		16	12.00	6	72.00	
308		16	12.00	2	24.00	
309		16	10.70	4	42.80	
310		16	10.70	2	21.40	
311		16	3.50	48	168.00	
312		16	2.65	32	84.80	
313		14	12.00	18	216.00	

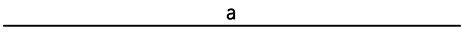
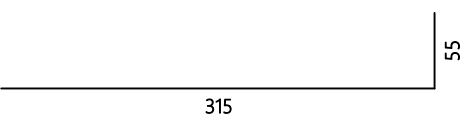
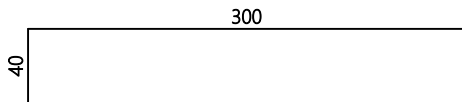
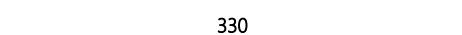
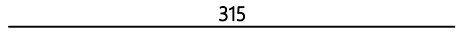
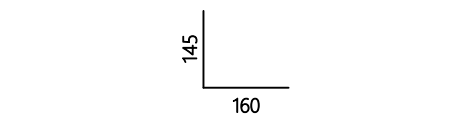
ISKAZ ARMATURE		
GRAĐEVINA:	REKONSTRUKCIJA TERMALNOG REKREACIJSKOG CENTRA TERME TUHELJ	
ISKAZ UZ NACRT:	ARM_E0_601-603_0	
SADRŽAJ:	ARMATURA STROPNE PLOČE PRIZEMLJA	
DATUM:	svibanj, 2023.	2/15

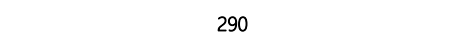
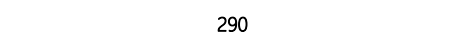
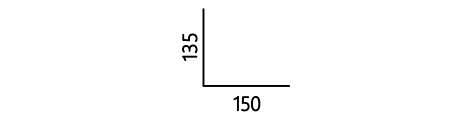
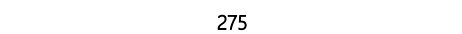
Šipke - specifikacija						
ozn	oblik i mjere [cm]	Ø	lg [m]	n [kom]	lgn [m]	Napomena
314		14	11.20	8	89.60	
315		14	9.60	4	38.40	
316		14	9.50	6	57.00	
317		14	8.85	4	35.40	
318		14	8.75	12	105.00	
319		14	8.50	4	34.00	
320		14	8.05	8	64.40	
321		14	7.95	12	95.40	
322		14	6.20	8	49.60	
323		14	5.95	6	35.70	
324		14	5.60	4	22.40	
325		14	5.40	4	21.60	
326		14	5.35	8	42.80	
327	 <p>2 x : a = 20, 38, 57, 75, 93, 112, 130, 148, 167, 185, 203, 222</p>	14	*2.94	2 x 12	70.48	
328		14	4.85	8	38.80	
329	 <p>2 x : a = 20, 27, 34, 41, 49, 56, 63, 70, 77, 84, 91, 98, 106, 113, 120, 127, 134, 141, 148, 155, 163, 170, 177, 184, 191, 198, 205</p>	14	*2.83	2 x 27	153.00	
330		14	4.60	4	18.40	
331		14	4.50	2	9.00	
332	 <p>4 x : a = 70, 87, 104, 120, 137, 154, 171, 187, 204, 221, 238, 254, 271, 288, 305, 321, 338, 355, 372, 388, 405, 422, 439</p>	14	*2.54	4 x 23	234.04	
333		14	4.20	8	33.60	

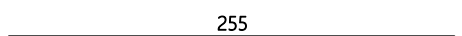
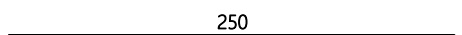
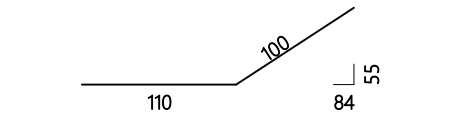
ISKAZ ARMATURE		
GRAĐEVINA:	REKONSTRUKCIJA TERMALNOG REKREACIJSKOG CENTRA TERME TUHELJ	
ISKAZ UZ NACRT:	ARM_EO_601-603_0	
SADRŽAJ:	ARMATURA STROPNE PLOČE PRIZEMLJA	
DATUM:	svibanj, 2023.	3/15



Šipke - specifikacija						
ozn	oblik i mjere [cm]	Ø	lg [m]	n [kom]	lgn [m]	Napomena
334	 <p>4 x : a = 393, 380, 367, 354, 341, 328, 315, 301, 288, 275, 262, 249, 236, 223, 210</p>	14	*3.01	4 x 15	180.88	
335		14	3.70	16	59.20	
336		14	3.40	4	13.60	
337		14	3.30	4	13.20	
338		14	3.15	8	25.20	
339		14	3.05	4	12.20	
340		14	3.00	99	297.00	
341		14	2.95	4	11.80	
342		14	2.90	6	17.40	
343		14	2.90	6	17.40	
344		14	2.85	4	11.40	
345		14	2.75	8	22.00	
346		14	2.75	16	44.00	
347		14	2.55	8	20.40	
348		14	2.50	8	20.00	
349		14	2.10	20	42.00	
350		14	2.00	14	28.00	
351		14	1.95	32	62.40	

ISKAZ ARMATURE

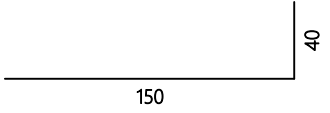
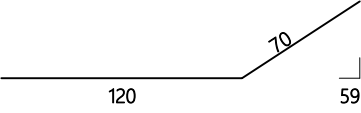
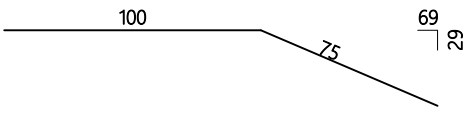
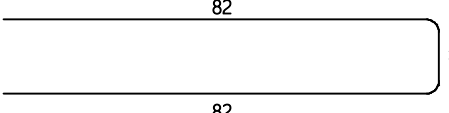
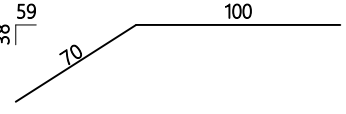
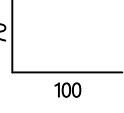
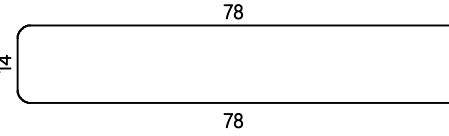
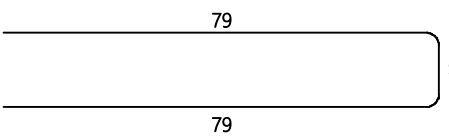
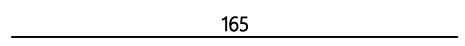
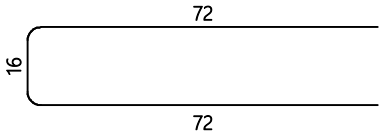
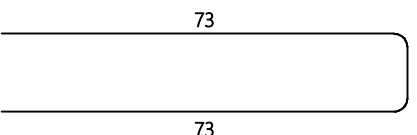
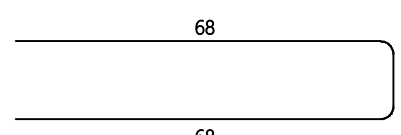
GRAĐEVINA:	REKONSTRUKCIJA TERMALNOG REKREACIJSKOG CENTRA TERME TUHELJ	
ISKAZ UZ NACRT:	ARM_E0_601-603_0	
SADRŽAJ:	ARMATURA STROPNE PLOČE PRIZEMLJA	
DATUM:	svibanj, 2023.	4/15

Šipke - specifikacija						
ozn	oblik i mjere [cm]	Ø	lg [m]	n [kom]	lgn [m]	Napomena
352		14	1.90	8	15.20	
353		14	1.90	20	38.00	
354		14	1.75	8	14.00	
355		14	1.75	46	80.50	
356		14	1.70	18	30.60	
357		14	1.70	16	27.20	
358		14	1.70	60	102.00	
359		14	1.70	46	78.20	
360		14	1.65	4	6.60	
361		14	1.60	16	25.60	
362		14	1.60	26	41.60	
363		12	1.50	80	120.00	

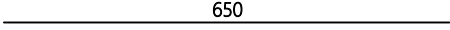
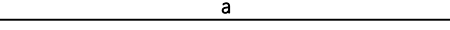
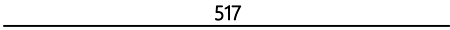
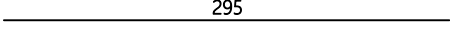
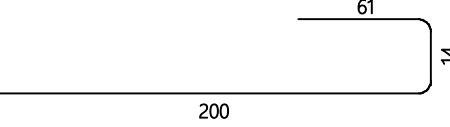
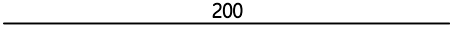
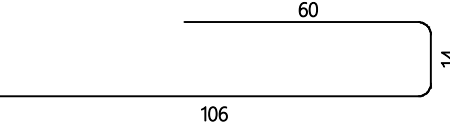
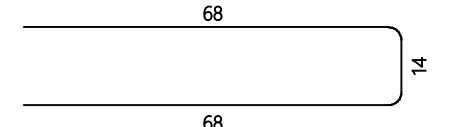
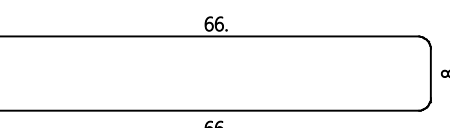
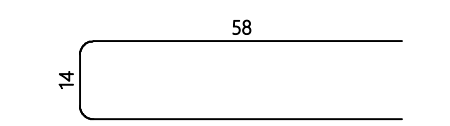
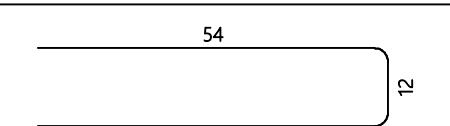
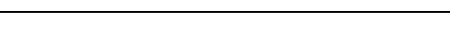
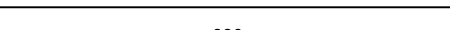
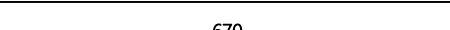
ISKAZ ARMATURE		
GRAĐEVINA:	REKONSTRUKCIJA TERMALNOG REKREACIJSKOG CENTRA TERME TUHELJ	
ISKAZ UZ NACRT:	ARM_E0_601-603_0	
SADRŽAJ:	ARMATURA STROPNE PLOČE PRIZEMLJA	
DATUM:	svibanj, 2023.	5/15

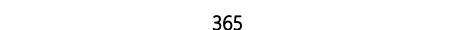
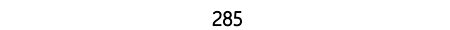
Šipke - specifikacija						
ozn	oblik i mjere [cm]	Ø	lg [m]	n [kom]	lgn [m]	Napomena
364		10	6.50	46	299.00	
365	 2 x : a = 550, 537, 523, 510, 496, 483, 469	10	*5.10	2 x 7	71.36	
366		10	5.17	14	72.38	
367		10	2.95	48	141.60	
368		10	2.75	24	66.00	
369		10	2.00	352	704.00	
370		10	1.80	90	162.00	
371		10	1.50	208	312.00	
372		10	1.40	32	44.80	
373		10	1.30	30	39.00	
374		10	1.20	432	518.40	
375		8	12.00	12	144.00	
376		8	8.90	6	53.40	
377		8	6.70	96	643.20	
378		8	6.50	46	299.00	
379		8	3.65	8	29.20	
380		8	2.85	32	91.20	

ISKAZ ARMATURE		
GRAĐEVINA:	REKONSTRUKCIJA TERMALNOG REKREACIJSKOG CENTRA TERME TUHELJ	
ISKAZ UZ NACRT:	ARM_E0_601-603_0	
SADRŽAJ:	ARMATURA STROPNE PLOČE PRIZEMLJA	
DATUM:	svibanj, 2023.	6/15

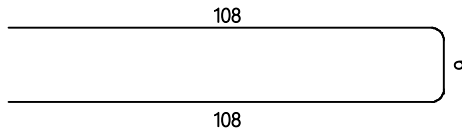
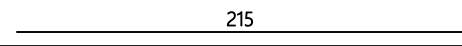
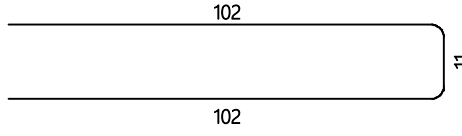
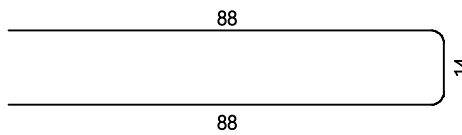
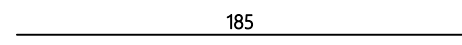
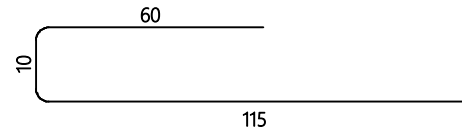
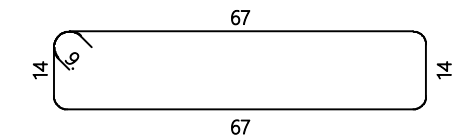
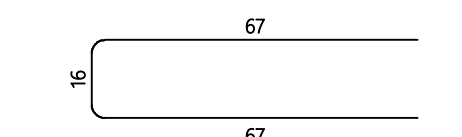
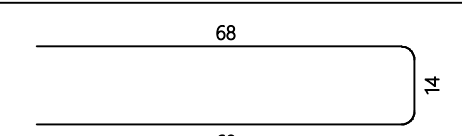
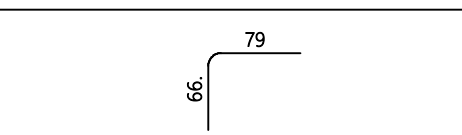
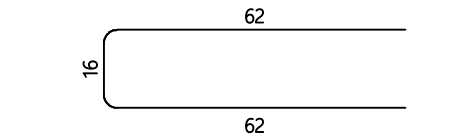
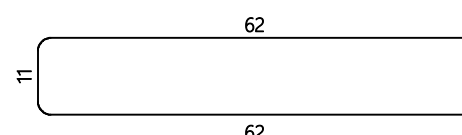
Šipke - specifikacija						
ozn	oblik i mjere [cm]	Ø	lg [m]	n [kom]	lgn [m]	Napomena
381		8	2.25	30	67.50	
382		8	2.15	51	109.65	
383		8	2.15	6	12.90	
384		8	1.90	26	49.40	
385		8	1.85	12	22.20	
386		8	1.85	34	62.90	
387		8	1.80	208	374.40	
388		8	1.50	24	36.00	
389		8	1.50	18	27.00	
390		8	1.45	70	101.50	
391		8	1.40	64	89.60	
392		8	1.35	16	21.60	

ISKAZ ARMATURE	
GRAĐEVINA:	REKONSTRUKCIJA TERMALNOG REKREACIJSKOG CENTRA TERME TUHELJ
ISKAZ UZ NACRT:	ARM_E0_601-603_0
SADRŽAJ:	ARMATURA STROPNE PLOČE PRIZEMLJA
DATUM:	svibanj, 2023. 7/15

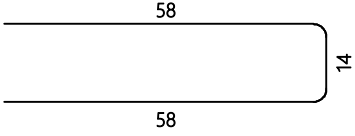
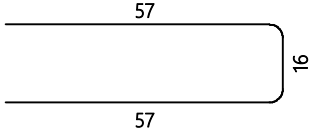
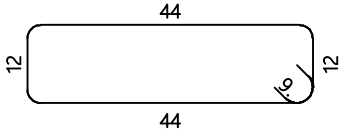
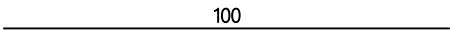
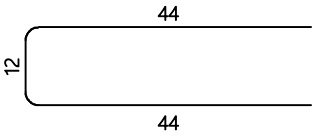
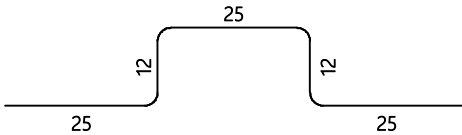
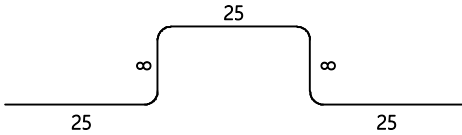
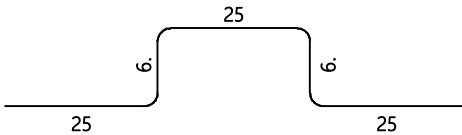
Šipke - specifikacija						
ozn	oblik i mjere [cm]	Ø	lg [m]	n [kom]	lgn [m]	Napomena
393		8	1.30	406	527.80	
394		8	1.30	280	364.00	
395		8	1.30	61	79.30	
396		8	1.00	624	624.00	
397		8	1.00	6	6.00	
398		8	0.99	760	752.40	
399		8	0.91	128	116.48	
400		8	0.87	34	29.58	

ISKAZ ARMATURE		
GRAĐEVINA:	REKONSTRUKCIJA TERMALNOG REKREACIJSKOG CENTRA TERME TUHELJ	
ISKAZ UZ NACRT:	ARM_E0_601-603_0	
SADRŽAJ:	ARMATURA STROPNE PLOČE PRIZEMLJA	
DATUM:	svibanj, 2023.	8/15

Šipke - rekapitulacija			
Ø [mm]	lgn [m]	Jedinična težina [kg/m']	Težina [kg]
B500B			
8	4734.21	0.40	1870.01
10	2430.54	0.62	1499.64
12	120.00	0.89	106.56
14	2822.20	1.21	3414.86
16	461.00	1.58	728.38
20	212.40	2.47	524.63
Ukupno (B500B)			8144.09
Ukupno			8144.09

ISKAZ ARMATURE		
GRAĐEVINA:	REKONSTRUKCIJA TERMALNOG REKREACIJSKOG CENTRA TERME TUHELJ	
ISKAZ UZ NACRT:	ARM_E0_601-603_0	
SADRŽAJ:	ARMATURA STROPNE PLOČE PRIZEMLJA	
DATUM:	svibanj, 2023.	9/15

Mreže - specifikacija							
Pozicija	Oznaka mreže	B [cm]	L [cm]	n	Jedinična težina [kg/m ²]	Ukupna težina [kg]	Napomena
Armatura stropne ploče prizemlja (1 kom)							
1	Q-335	215	600	20	5.38	1388.04	
1-1	Q-335	190	300	1	5.38	30.67	
1-2	Q-335	190	600	1	5.38	61.33	
1-3	Q-335	190	300	1	5.38	30.66	
1-4	Q-335	215	330	4	5.38	152.68	
1-5	Q-335	120	330	1	5.38	21.31	
1-6	Q-335	190	441	1	5.38	45.03	
1-7	Q-335	190	600	1	5.38	61.33	
1-8	Q-335	190	441	1	5.38	45.03	
1-9	Q-335	215	155	2	5.38	35.86	
1-10	Q-335	215	245	16	5.38	453.43	
1-11	Q-335	110	600	4	5.38	142.03	
1-12	Q-335	110	245	4	5.38	58.00	
1-13	Q-335	215	105	2	5.38	24.29	
1-17	Q-335	170	570	2	5.38	104.26	
1-19	Q-335	215	600	2	5.38	138.80	
1-20	Q-335	215	155	2	5.38	35.86	
1-21	Q-335	90	437	2	5.38	42.29	
2	Q-257	215	600	6	4.12	318.89	
2-1	Q-257	178	600	2	4.12	87.76	
2-2	Q-257	103	190	1	4.12	8.02	
2-3	Q-257	215	235	12	4.12	249.80	
2-4	Q-257	215	600	13	4.12	690.92	
2-5	Q-257	85	190	1	4.12	6.69	
2-6	Q-257	205	235	1	4.12	19.90	
2-7	Q-257	215	190	1	4.12	16.83	
2-8	Q-257	202	235	1	4.12	19.60	
2-9	Q-257	82	190	1	4.12	6.46	
2-10	Q-257	105	190	1	4.12	8.26	
2-11	Q-257	190	600	4	4.12	187.87	
2-12	Q-257	168	145	2	4.12	20.10	
2-13	Q-257	215	385	2	4.12	68.21	
2-14	Q-257	215	330	2	4.12	58.46	
2-15	Q-257	120	385	1	4.12	19.03	
2-16	Q-257	170	570	2	4.12	79.85	
2-17	Q-257	215	485	2	4.12	86.00	
2-18	Q-257	215	557	2	4.12	98.68	

ISKAZ ARMATURE		
GRAĐEVINA:	REKONSTRUKCIJA TERMALNOG REKREACIJSKOG CENTRA TERME TUHELJ	
ISKAZ UZ NACRT:	ARM_E0_601-603_0	
SADRŽAJ:	ARMATURA STROPNE PLOČE PRIZEMLJA	
DATUM:	svibanj, 2023.	10/15

Mreže - specifikacija							
Pozicija	Oznaka mreže	B [cm]	L [cm]	n	Jedinična težina [kg/m ²]	Ukupna težina [kg]	Napomena
2-19	Q-257	200	600	2	4.12	98.88	
3-1	Q-524	115	600	10	8.31	573.39	
3-2	Q-524	115	435	2	8.31	83.14	
Ukupno						5677.64	

ISKAZ ARMATURE		
GRAĐEVINA:	REKONSTRUKCIJA TERMALNOG REKREACIJSKOG CENTRA TERME TUHELJ	
ISKAZ UZ NACRT:	ARM_E1_601-603_0	
SADRŽAJ:	ARMATURA STROPNE PLOČE PRVOG KATA	
DATUM:	svibanj, 2023.	1/12

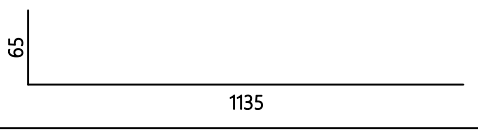
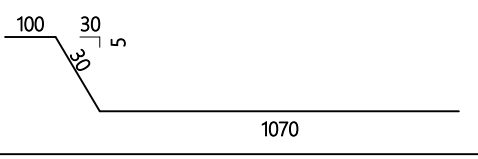
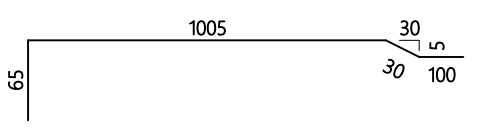
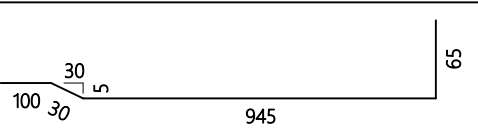
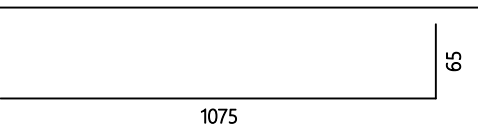
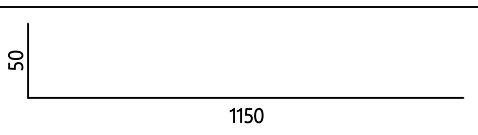
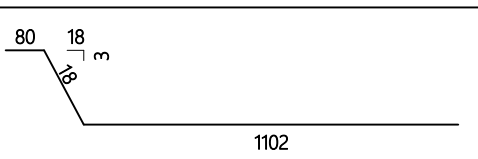
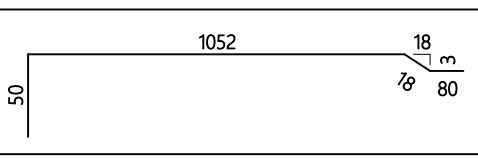
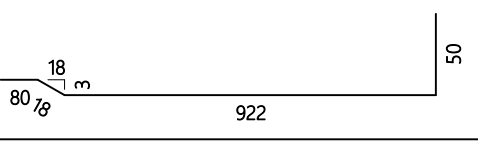
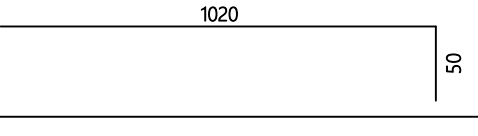
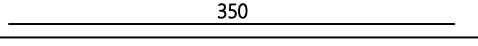
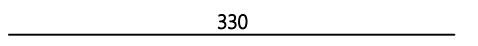
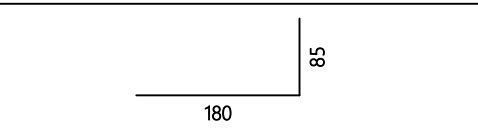
Šipke - specifikacija						
ozn	oblik i mjere [cm]	Ø	lg [m]	n [kom]	lgn [m]	Napomena
Armatura stropne ploče prvog kata (1 kom)						
401		20	12.00	2	24.00	
402		20	12.00	6	72.00	
403		20	12.00	4	48.00	
404		20	11.40	2	22.80	
405		20	11.40	4	45.60	
406		16	12.00	4	48.00	
407		16	12.00	6	72.00	
408		16	12.00	2	24.00	
409		16	10.70	4	42.80	
410		16	10.70	2	21.40	
411		16	3.50	48	168.00	
412		16	3.30	5	16.50	
413		16	2.65	16	42.40	

ISKAZ ARMATURE

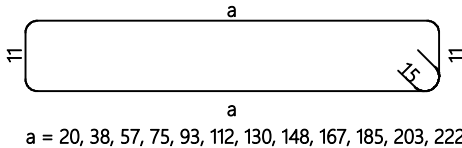
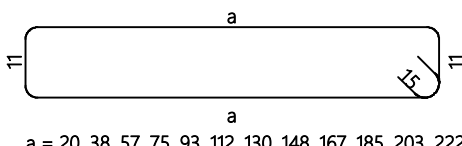
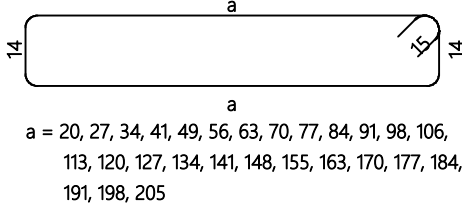

GRAĐEVINA:	REKONSTRUKCIJA TERMALNOG REKREACIJSKOG CENTRA TERME TUHELJ	
ISKAZ UZ NACRT:	ARM_E1_601-603_0	
SADRŽAJ:	ARMATURA STROPNE PLOČE PRVOG KATA	
DATUM:	svibanj, 2023.	2/12

Šipke - specifikacija						
ozn	oblik i mjere [cm]	Ø	lg [m]	n [kom]	lgn [m]	Napomena
414	_____ 250 _____	16	2.50	15	37.50	
415	_____ 1200 _____	14	12.00	18	216.00	
416	_____ 1120 _____	14	11.20	8	89.60	
417	_____ 960 _____	14	9.60	4	38.40	
418	_____ 950 _____	14	9.50	6	57.00	
419	_____ 885 _____	14	8.85	4	35.40	
420	_____ 875 _____	14	8.75	12	105.00	
421	_____ 850 _____	14	8.50	4	34.00	
422	_____ 805 _____	14	8.05	8	64.40	
423	_____ 795 _____	14	7.95	12	95.40	
424	_____ 620 _____	14	6.20	8	49.60	
425	_____ 595 _____	14	5.95	6	35.70	
426	_____ 560 _____	14	5.60	4	22.40	
427	_____ 540 _____	14	5.40	4	21.60	
428	_____ 535 _____	14	5.35	8	42.80	
429	 <p>a = 20, 38, 57, 75, 93, 112, 130, 148, 167, 185, 203, 222</p>	14	*2.94	1 x 12	35.24	
430	 <p>a = 20, 38, 57, 75, 93, 112, 130, 148, 167, 185, 203, 222</p>	14	*2.94	1 x 12	35.24	
431	_____ 485 _____	14	4.85	8	38.80	
432	 <p>a = 20, 27, 34, 41, 49, 56, 63, 70, 77, 84, 91, 98, 106, 113, 120, 127, 134, 141, 148, 155, 163, 170, 177, 184, 191, 198, 205</p>	14	*2.83	1 x 27	76.50	

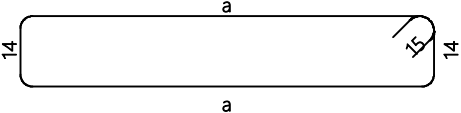
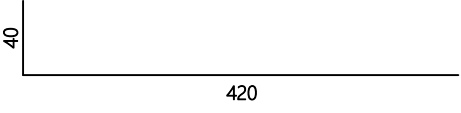
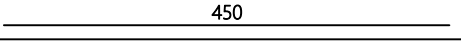
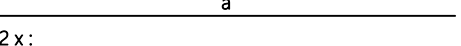
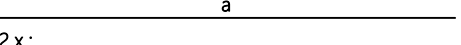
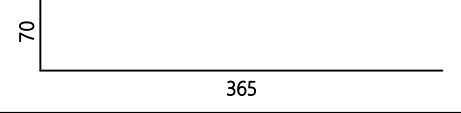
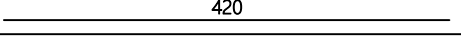
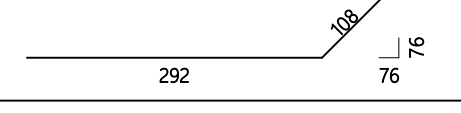
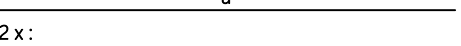
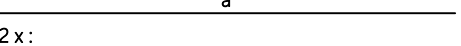
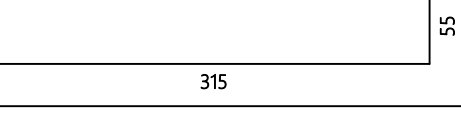
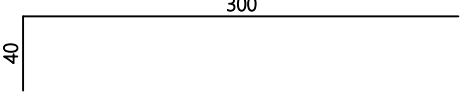

ISKAZ ARMATURE		
GRAĐEVINA:	REKONSTRUKCIJA TERMALNOG REKREACIJSKOG CENTRA TERME TUHELJ	
ISKAZ UZ NACRT:	ARM_E1_601-603_0	
SADRŽAJ:	ARMATURA STROPNE PLOČE PRVOG KATA	
DATUM:	svibanj, 2023.	3/12

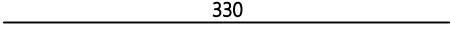
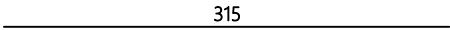
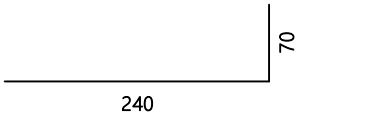
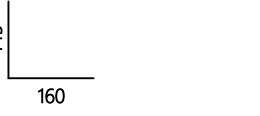
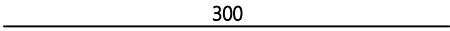
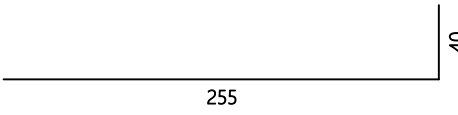
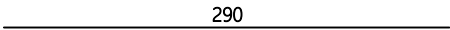
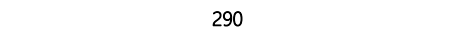
Šipke - specifikacija						
ozn	oblik i mjere [cm]	Ø	lg [m]	n [kom]	lgn [m]	Napomena
433	 <p>a = 20, 27, 34, 41, 49, 56, 63, 70, 77, 84, 91, 98, 106, 113, 120, 127, 134, 141, 148, 155, 163, 170, 177, 184, 191, 198, 205</p>	14	*2.83	1 x 27	76.50	
434		14	4.60	4	18.40	
435		14	4.50	2	9.00	
436	 <p>2 x : a = 70, 87, 104, 120, 137, 154, 171, 187, 204, 221, 238, 254, 271, 288, 305, 321, 338, 355, 372, 388, 405, 422, 439</p>	14	*2.54	2 x 23	117.02	
437	 <p>2 x : a = 70, 87, 104, 120, 137, 154, 171, 187, 204, 221, 238, 254, 271, 288, 305, 321, 338, 355, 372, 388, 405, 422, 439</p>	14	*2.54	2 x 23	117.02	
438		14	4.35	2	8.70	
439		14	4.20	8	33.60	
440		14	4.00	2	8.00	
441	 <p>2 x : a = 393, 380, 367, 354, 341, 328, 315, 301, 288, 275, 262, 249, 236, 223, 210</p>	14	*3.01	2 x 15	90.44	
442	 <p>2 x : a = 393, 380, 367, 354, 341, 328, 315, 301, 288, 275, 262, 249, 236, 223, 210</p>	14	*3.01	2 x 15	90.44	
443		14	3.70	16	59.20	
444		14	3.40	2	6.80	

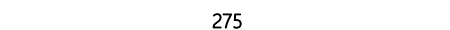
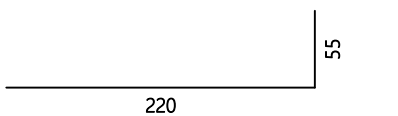
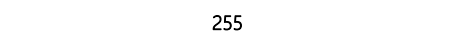
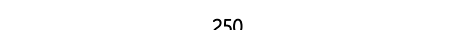
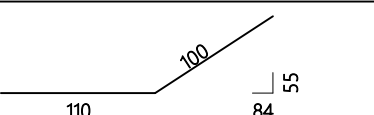
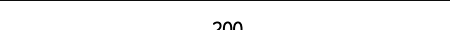
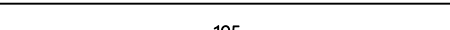
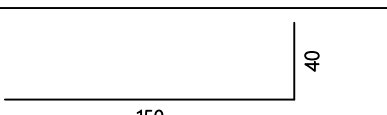
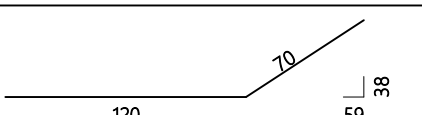
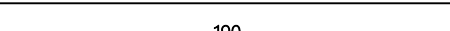
ISKAZ ARMATURE		
GRAĐEVINA:	REKONSTRUKCIJA TERMALNOG REKREACIJSKOG CENTRA TERME TUHELJ	
ISKAZ UZ NACRT:	ARM_E1_601-603_0	
SADRŽAJ:	ARMATURA STROPNE PLOČE PRVOG KATA	
DATUM:	svibanj, 2023.	4/12

Šipke - specifikacija						
ozn	oblik i mjere [cm]	Ø	lg [m]	n [kom]	lgn [m]	Napomena
445		14	3.30	4	13.20	
446		14	3.15	8	25.20	
447		14	3.10	2	6.20	
448		14	3.05	4	12.20	
449		14	3.00	99	297.00	
450		14	2.95	4	11.80	
451		14	2.90	8	23.20	
452		14	2.90	6	17.40	
453		14	2.85	4	11.40	
454		14	2.75	8	22.00	
455		14	2.75	14	38.50	
456		14	2.55	8	20.40	
457		14	2.50	8	20.00	
458		14	2.10	20	42.00	
459		14	2.00	20	40.00	
460		14	1.95	28	54.60	
461		14	1.90	4	7.60	
462		14	1.90	20	38.00	
463		14	1.90	2	3.80	

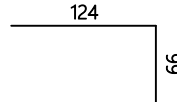
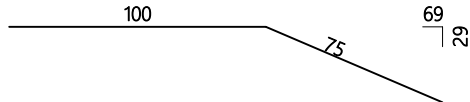
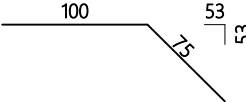
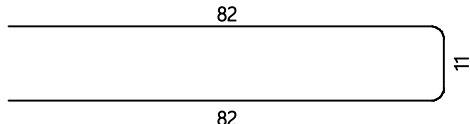
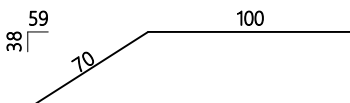
ISKAZ ARMATURE		
GRAĐEVINA:	REKONSTRUKCIJA TERMALNOG REKREACIJSKOG CENTRA TERME TUHELJ	
ISKAZ UZ NACRT:	ARM_E1_601-603_0	
SADRŽAJ:	ARMATURA STROPNE PLOČE PRVOG KATA	
DATUM:	svibanj, 2023.	5/12

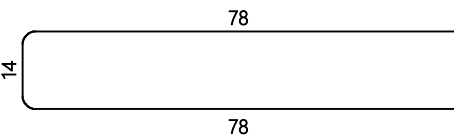
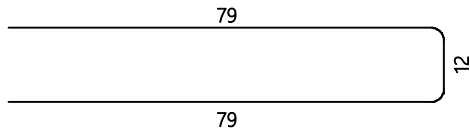
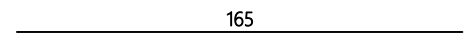
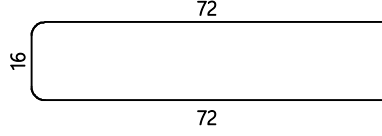
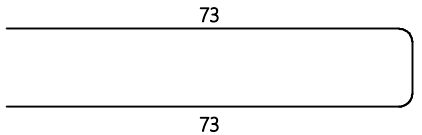
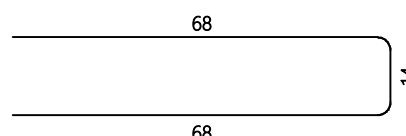
Šipke - specifikacija						
ozn	oblik i mjere [cm]	Ø	lg [m]	n [kom]	lgn [m]	Napomena
464		14	1.90	10	19.00	
465		14	1.75	8	14.00	
466		14	1.75	4	7.00	
467		14	1.75	46	80.50	
468		14	1.70	18	30.60	
469		14	1.70	16	27.20	
470		14	1.70	60	102.00	
471		14	1.70	46	78.20	
472		14	1.65	4	6.60	
473		14	1.60	16	25.60	
474		14	1.60	26	41.60	
475		12	1.50	76	114.00	

ISKAZ ARMATURE		
GRAĐEVINA:	REKONSTRUKCIJA TERMALNOG REKREACIJSKOG CENTRA TERME TUHELJ	
ISKAZ UZ NACRT:	ARM_E1_601-603_0	
SADRŽAJ:	ARMATURA STROPNE PLOČE PRVOG KATA	
DATUM:	svibanj, 2023.	6/12

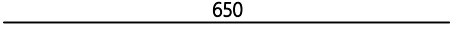
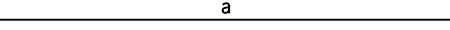
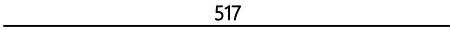
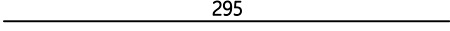
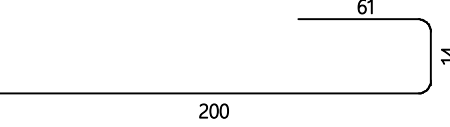
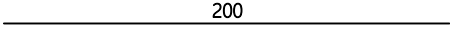
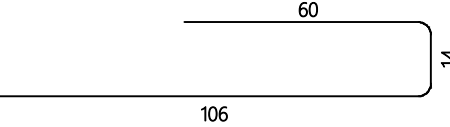
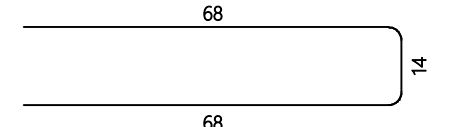
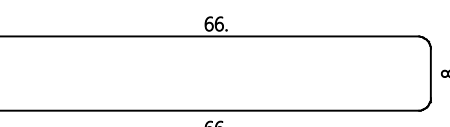
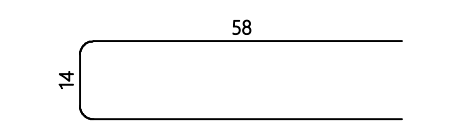
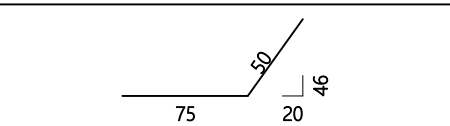
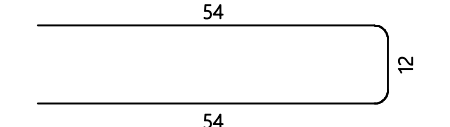
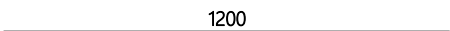
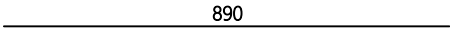
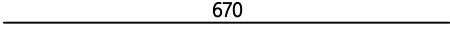
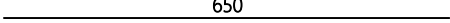
Šipke - specifikacija						
ozn	oblik i mjere [cm]	Ø	lg [m]	n [kom]	lgn [m]	Napomena
476		10	6.50	46	299.00	
477	 2 x : a = 550, 537, 523, 510, 496, 483, 469	10	*5.10	2 x 7	71.36	
478		10	5.17	14	72.38	
479		10	2.95	37	109.15	
480		10	2.75	35	96.25	
481		10	2.00	320	640.00	
482		10	1.80	90	162.00	
483		10	1.50	208	312.00	
484		10	1.40	28	39.20	
485		10	1.30	30	39.00	
486		10	1.25	16	20.00	
487		10	1.20	432	518.40	
488		8	12.00	12	144.00	
489		8	8.90	6	53.40	
490		8	6.70	96	643.20	
491		8	6.50	46	299.00	

ISKAZ ARMATURE

GRAĐEVINA:	REKONSTRUKCIJA TERMALNOG REKREACIJSKOG CENTRA TERME TUHELJ	
ISKAZ UZ NACRT:	ARM_E1_601-603_0	
SADRŽAJ:	ARMATURA STROPNE PLOČE PRVOG KATA	
DATUM:	svibanj, 2023.	7/12

Šipke - specifikacija						
ozn	oblik i mjere [cm]	Ø	lg [m]	n [kom]	lgn [m]	Napomena
492		8	4.25	3	12.75	
493		8	3.65	8	29.20	
494		8	3.35	3	10.05	
495		8	2.85	28	79.80	
496		8	2.25	30	67.50	
497		8	2.15	51	109.65	
498		8	2.15	6	12.90	
499		8	2.10	6	12.60	
500		8	2.05	6	12.30	
501		8	1.90	26	49.40	
502		8	1.85	12	22.20	
503		8	1.85	17	31.45	
504		8	1.80	208	374.40	
505		8	1.50	24	36.00	
506		8	1.50	18	27.00	

ISKAZ ARMATURE	
GRAĐEVINA:	REKONSTRUKCIJA TERMALNOG REKREACIJSKOG CENTRA TERME TUHELJ
ISKAZ UZ NACRT:	ARM_E1_601-603_0
SADRŽAJ:	ARMATURA STROPNE PLOČE PRVOG KATA
DATUM:	svibanj, 2023. 8/12

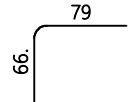
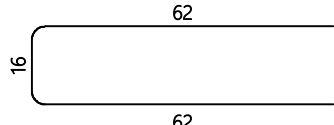
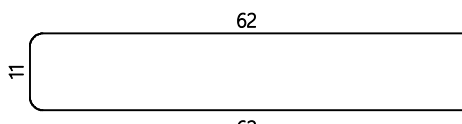
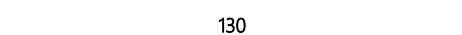
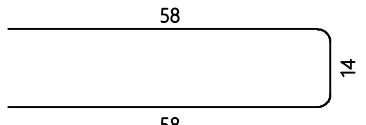
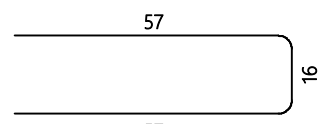
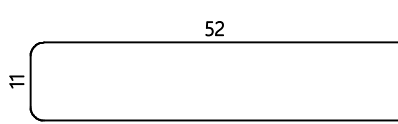
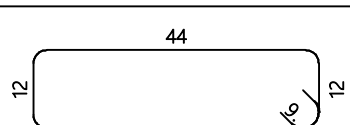
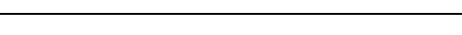
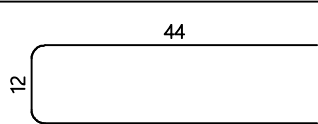
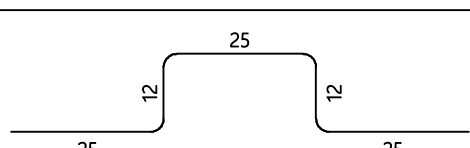
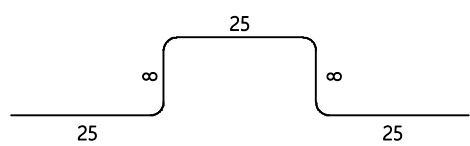
Šipke - specifikacija						
ozn	oblik i mjere [cm]	Ø	lg [m]	n [kom]	lgn [m]	Napomena
507		8	1.45	44	63.80	
508		8	1.40	64	89.60	
509		8	1.35	16	21.60	
510		8	1.30	27	35.10	
511		8	1.30	434	564.20	
512		8	1.30	321	417.30	
513		8	1.15	3	3.45	
514		8	1.30	55	71.50	
515		8	1.00	622	622.00	
516		8	1.00	6	6.00	
517		8	0.99	760	752.40	
518		8	0.91	128	116.48	

ISKAZ ARMATURE	
GRAĐEVINA:	REKONSTRUKCIJA TERMALNOG REKREACIJSKOG CENTRA TERME TUHELJ
ISKAZ UZ NACRT:	ARM_E1_601-603_0
SADRŽAJ:	ARMATURA STROPNE PLOČE PRVOG KATA
DATUM:	svibanj, 2023. 9/12

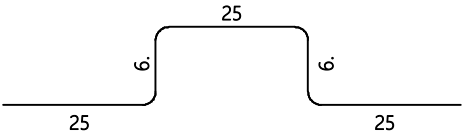
Šipke - specifikacija						
ozn	oblik i mjere [cm]	Ø	lg [m]	n [kom]	lgn [m]	Napomena
519		8	0.87	36	31.32	

ISKAZ ARMATURE		
GRAĐEVINA:	REKONSTRUKCIJA TERMALNOG REKREACIJSKOG CENTRA TERME TUHELJ	
ISKAZ UZ NACRT:	ARM_E1_601-603_0	
SADRŽAJ:	ARMATURA STROPNE PLOČE PRVOG KATA	
DATUM:	svibanj, 2023.	10/12

Šipke - rekapitulacija			
Ø [mm]	lgn [m]	Jedinična težina [kg/m']	Težina [kg]
B500B			
8	4821.55	0.40	1904.51
10	2378.74	0.62	1467.68
12	114.00	0.89	101.23
14	2865.00	1.21	3466.65
16	472.60	1.58	746.71
20	212.40	2.47	524.63
Ukupno (B500B)			8211.41
Ukupno			8211.41

ISKAZ ARMATURE		
GRAĐEVINA:	REKONSTRUKCIJA TERMALNOG REKREACIJSKOG CENTRA TERME TUHELJ	
ISKAZ UZ NACRT:	ARM_E1_601-603_0	
SADRŽAJ:	ARMATURA STROPNE PLOČE PRVOG KATA	
DATUM:	svibanj, 2023.	11/12

Mreže - specifikacija							
Pozicija	Oznaka mreže	B [cm]	L [cm]	n	Jedinična težina [kg/m ²]	Ukupna težina [kg]	Napomena
Armatura stropne ploče prvog kata (1 kom)							
1	Q-335	215	600	20	5.38	1388.04	
1-1	Q-335	190	300	1	5.38	30.67	
1-2	Q-335	190	600	1	5.38	61.33	
1-3	Q-335	190	300	1	5.38	30.66	
1-4	Q-335	215	330	4	5.38	152.68	
1-5	Q-335	120	330	1	5.38	21.31	
1-6	Q-335	190	441	1	5.38	45.03	
1-7	Q-335	190	600	1	5.38	61.33	
1-8	Q-335	190	441	1	5.38	45.03	
1-9	Q-335	215	155	2	5.38	35.86	
1-10	Q-335	215	245	16	5.38	453.43	
1-11	Q-335	110	600	4	5.38	142.03	
1-12	Q-335	110	245	4	5.38	58.00	
1-13	Q-335	215	105	2	5.38	24.29	
1-17	Q-335	170	570	2	5.38	104.26	
1-19	Q-335	215	600	2	5.38	138.80	
1-20	Q-335	215	155	2	5.38	35.86	
1-21	Q-335	90	437	2	5.38	42.29	
2	Q-257	215	600	6	4.12	318.89	
2-1	Q-257	178	600	2	4.12	87.76	
2-2	Q-257	103	190	1	4.12	8.02	
2-3	Q-257	215	235	11	4.12	228.98	
2-4	Q-257	215	600	13	4.12	690.92	
2-5	Q-257	82	190	1	4.12	6.46	
2-6	Q-257	202	235	1	4.12	19.61	
2-7	Q-257	215	190	1	4.12	16.83	
2-8	Q-257	202	235	1	4.12	19.60	
2-9	Q-257	82	190	1	4.12	6.46	
2-10	Q-257	215	185	1	4.12	16.39	
2-11	Q-257	173	190	1	4.12	13.54	
2-12	Q-257	190	600	4	4.12	187.87	
2-13	Q-257	168	145	2	4.12	20.10	
2-14	Q-257	215	385	2	4.12	68.21	
2-15	Q-257	215	330	2	4.12	58.46	
2-16	Q-257	120	385	1	4.12	19.03	
2-17	Q-257	170	570	2	4.12	79.85	
2-18	Q-257	215	485	2	4.12	86.00	

ISKAZ ARMATURE		
GRAĐEVINA:	REKONSTRUKCIJA TERMALNOG REKREACIJSKOG CENTRA TERME TUHELJ	
ISKAZ UZ NACRT:	ARM_E1_601-603_0	
SADRŽAJ:	ARMATURA STROPNE PLOČE PRVOG KATA	
DATUM:	svibanj, 2023.	12/12

Mreže - specifikacija							
Polozicija	Oznaka mreže	B [cm]	L [cm]	n	Jedinična težina [kg/m ²]	Ukupna težina [kg]	Napomena
2-19	Q-257	215	557	2	4.12	98.68	
2-20	Q-257	200	600	2	4.12	98.88	
3-1	Q-524	115	600	10	8.31	573.39	
3-2	Q-524	115	435	2	8.31	83.14	
Ukupno						5677.97	

STROPNA PLOČA DRUGOG KATA SMJEŠTAINOG PAVILJONA
NACRT SAVIJANJA ARMATURE GORNJE ZONE
M 1:50

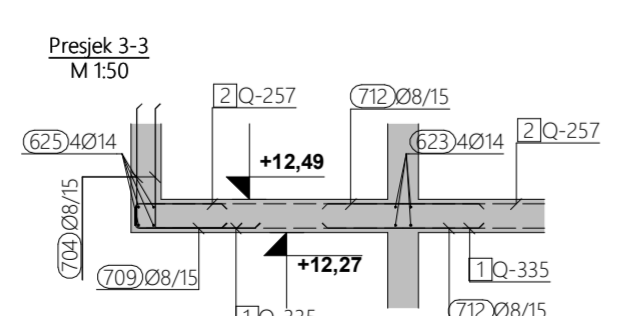
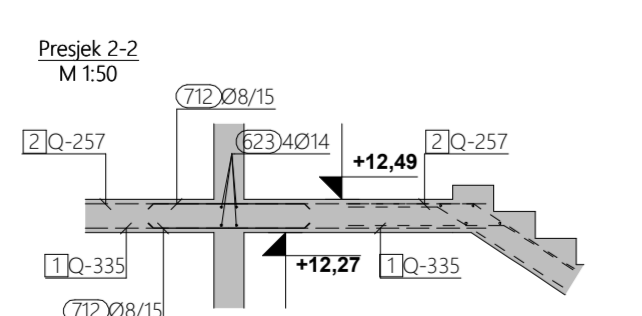
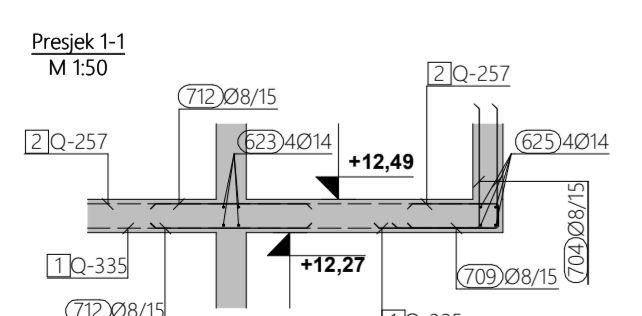
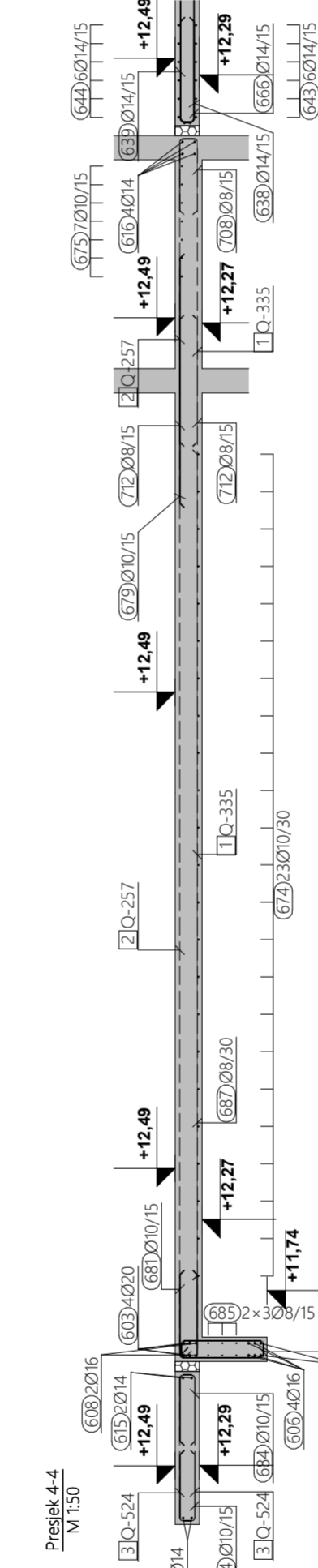
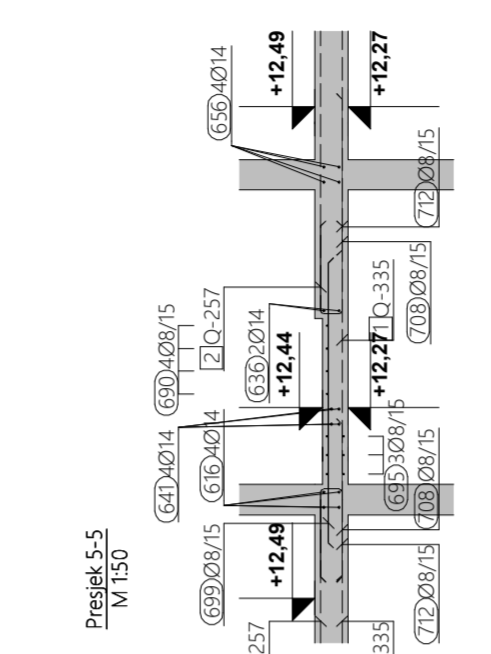
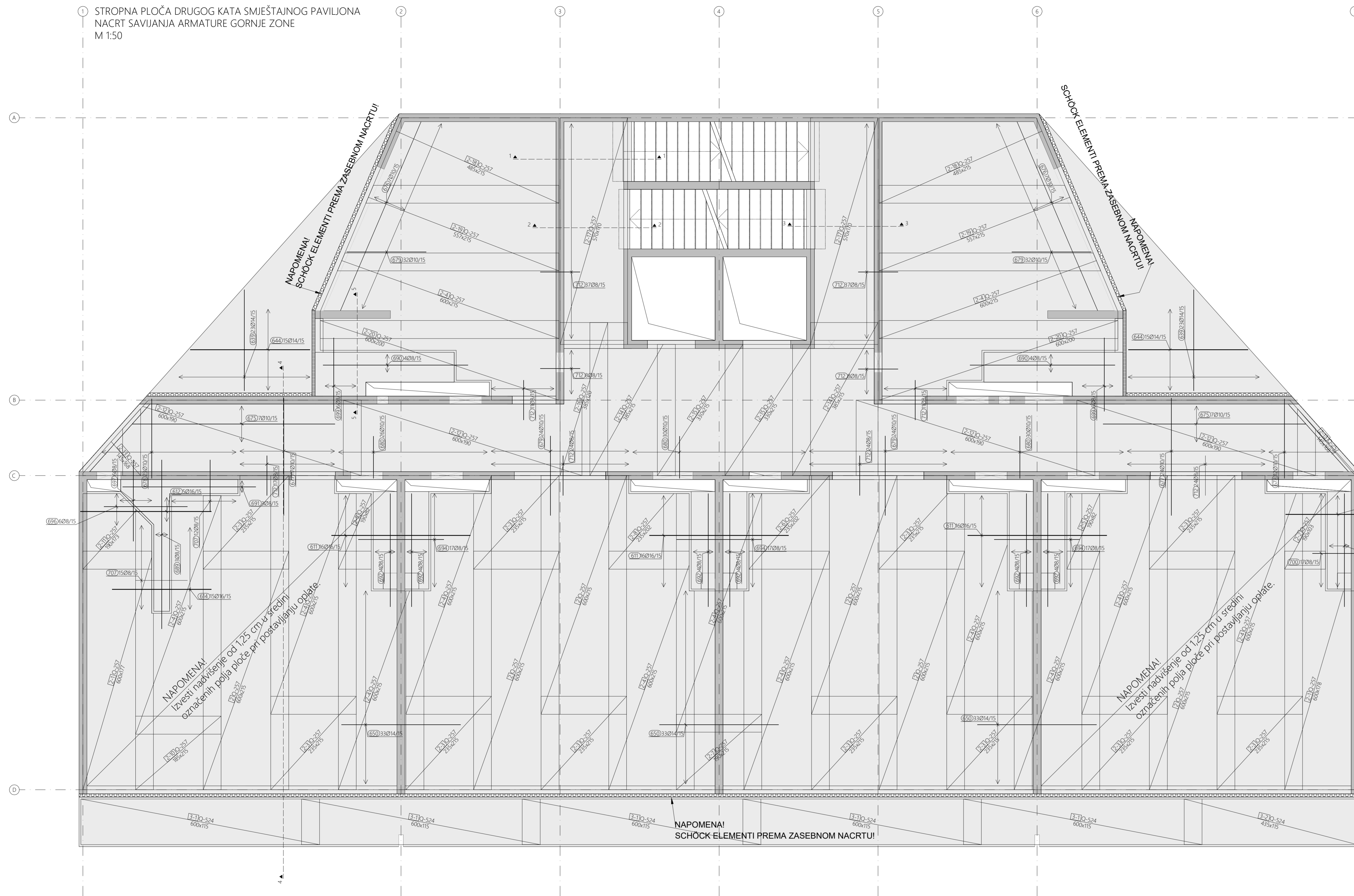

JAHAČI - 2 KOM / m2
PLOČA d=22 cm

JAHAČI - 2 KOM / m2
PLOČA d=20 cm

JAHAČI - 2 KOM / m2
PLOČA d=16 cm

Šipke - specifikacija

ozn.	ozn. i mjere (cm)	Ø	lg [m]	n (kom)	lgm [m]
Amaturna stropna ploča drugog kata (1 kom)					
601	1135	20	12.00	2	24.00
602	1070	20	12.00	6	72.00
603	1005	20	12.00	4	48.00
604	945	20	11.40	2	22.80
605	875	20	11.40	4	45.60
606	815	16	12.00	4	48.00
607	755	16	12.00	6	72.00
608	695	16	12.00	2	24.00
609	635	16	10.70	4	42.80
610	575	16	10.70	2	21.40
611	515	16	3.50	48	168.00
612	455	16	3.30	5	16.50
613	395	16	2.65	16	42.40
614	335	16	2.50	15	37.50
615	275	14	12.00	36	216.00
616	215	14	11.20	12	134.40
617	155	14	9.60	4	38.40
618	95	14	9.50	6	57.00
619	35	14	8.85	4	35.40
620	25	14	8.75	12	105.00
621	15	14	8.50	4	34.00
622	5	14	8.05	8	64.40
623	0	14	7.95	12	95.40
624	-5	14	7.90	4	31.60
625	-10	14	6.55	8	52.40
626	-15	14	6.20	4	24.80
627	-20	14	5.95	4	23.80
628	-25	14	5.60	4	22.40
629	-30	14	5.40	4	21.60
630	-35	14	5.35	10	53.50
631	a	14	*2.94	1 x 12	35.24
632	a	14	*2.94	1 x 12	35.24
633	a	14	4.85	4	19.40
634	a	14	*2.83	1 x 27	76.50
635	a	14	*2.83	1 x 27	76.50
636	a	14	4.60	4	18.40
637	a	14	4.50	2	9.00
638	a	14	*2.54	2 x 23	117.02
639	a	14	*2.54	2 x 23	117.02
640	a	14	4.35	2	8.70
641	a	14	4.20	8	33.60
642	a	14	4.00	2	8.00

643	a	14	*3.01	2 x 15	90.44
644	a	14	*3.01	2 x 15	90.44
645	a	14	3.70	18	66.60
646	a	14	3.40	2	6.80
647	a	14	3.15	4	12.60
648	a	14	3.10	2	6.20
649	a	14	3.05	4	12.20
650	a	14	3.00	99	297.00
651	a	14	2.90	10	29.00
652	a	14	2.90	6	17.40
653	a	14	2.85	4	11.40
654	a	14	2.75	8	22.00
655	a	14	2.75	12	33.00
656	a	14	2.55	8	20.40
657	a	14	2.50	8	20.00
658	a	14	2.15	2	4.30
659	a	14	2.00	20	40.00
660	a	14	1.95	28	54.60
661	a	14	1.90	4	7.60
662	a	14	1.90	2	3.80
663	a	14	1.90	16	30.40
664	a	14	1.75	8	14.00
665	a	14	1.75	4	7.00
666	a	14	1.75	46	80.50
667	a	14	1.70	16	27.20
668	a	14	1.70	60	102.00
669	a	14	1.70	46	78.20
670	a	14	1.65	4	6.60
671	a	14	1.60	16	25.60
672	a	14	1.60	30	48.00
673	a	12	1.50	72	108.00
674	a	10	6.50	46	299.00
675	a	10	*5.30	2 x 7	71.36
676	a	10	5.17	14	72.38
677	a	10	2.95	41	120.95
678	a	10	2.75	35	96.25
679	a	10	2.00	320	640.00
680	a	10	1.80	86	154.80
681	a	10	1.50	208	312.00
682	a	10	1.40	28	39.20
683	a	10	1.30	30	39.00

684	a	10	1.20	432	518.40
685	a	8	12.00	12	144.00
686	a	8	8.90	6	53.40
687	a	8	6.70	96	643.20
688	a	8	6.50	46	299.00
689	a	8	4.25	3	12.75
690	a	8	3.65	8	29.20
691	a	8	3.35	3	10.05
692	a	8	2.85	28	79.80
693	a	8	2.25	30	67.50
694	a	8	2.15	54	109.65
695	a	8	2.15	6	12.90
696	a	8	2.10	8	12.60
697	a	8	2.05	6	12.30
698	a	8	1.90	26	49.40
699	a	8	1.85	12	22.20
700	a	8	1.85	17	31.45
701	a	8	1.80	208	374.40
702	a	8	1.50	24	36.00
703	a	8	1.50	18	27.00

704	a	8	1.45	90	130.50
705	a	8	1.40	64	89.60
706	a	8	1.35	16	21.60
707	a	8	1.30	27	35.10
708	a	8	1.30	430	559.00
709	a	8	1.30	34	44.30
710	a	8	1.15	3	3.45
711	a	8	1.30	52	67.60
712	a	8	1.00	630	630.00
713	a	8	1.00	6	6.00
714	a	8	0.99	760	752.40
715	a	8	0.91	128	116.48
716	a	8	0.87	36	31.32

NAPOMENA
Šipke prilagoditi i po potrebi rezati na licu mjesta. Preklap 50Z.

NAPOMENA
Sve dimenzije provjeriti prema važećim planovima oplate.

Klasa betona	C 25/30		
Armatura	B 500 B		
Zaštitni sloj betona			
dijelje	gore	bočno	Pripadajuća lista armature:
3.0 cm	3.0 cm	3.0 cm	ARM_E2.601-603_1SKAZ
Pripadajući armaturni nacrti			
ARM_E2.601-603			

<p>KONSTRUKTA</p> <p>KONSTRUKTA d.o.o. za projektiranje i nadzor Desinićka 20, ZAGREB, OIB: 06674376579 Zr: PRIVREDNA BANKA 2340009-1110164468 TEL: 0136 43 826; FAX: 0136 43 829 MAIL: info@konstrukt.hr</p>	<p>PEČAT I POTPIS:</p>
	<p>INVESTITOR: TERME TUHVELI d.o.o. Uspjenova Gata 4, Tuhejske Toplice, 49275 Tuhej</p> <p>GRADJEVINA: REKONSTRUKCIJA TERMALNOG REKREACIJSKOG CENTRA TERME TUHVELI</p> <p>LOKACIJA: na k.č.br. 3199/1, k.o. Črešnjevec</p> <p>FAZA: IZVEDBENI PROJEKT - ARMATURNI NACRTI</p> <p>SADRŽAJ: ELEMENT - SMJEŠTAINI PAVILJON ARMATURA STR. PLOČE DRUGOG KATA GORNJA ZONA</p>

ISKAZ ARMATURE

GRAĐEVINA:	REKONSTRUKCIJA TERMALNOG REKREACIJSKOG CENTRA TERME TUHELJ	
ISKAZ UZ NACRT:	ARM_E2_601-603_0	
SADRŽAJ:	ARMATURA STROPNE PLOČE DRUGOG KATA	
DATUM:	svibanj, 2023.	1/11

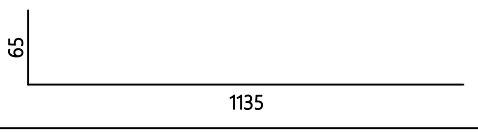
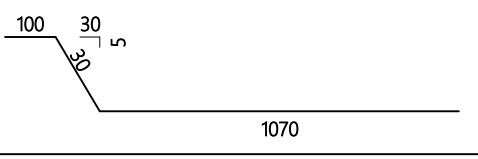
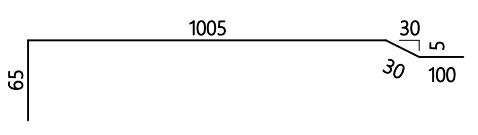
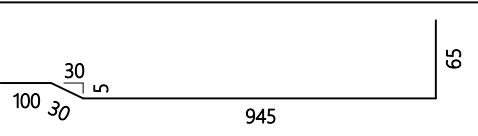
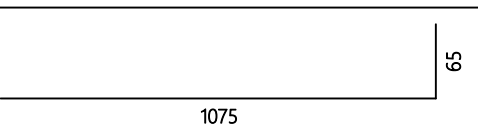
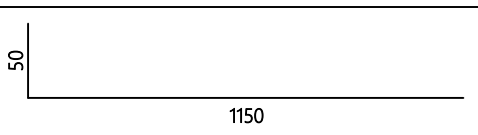
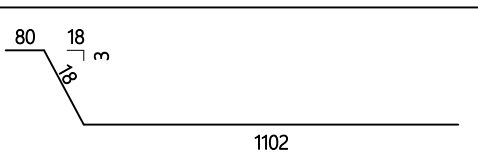
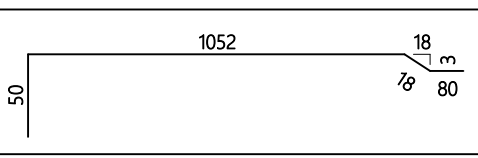
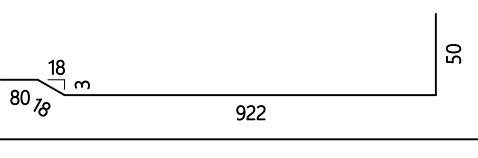
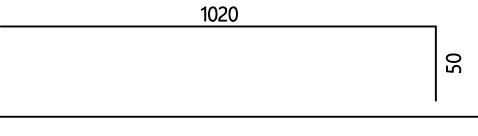
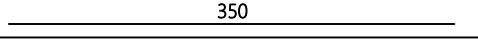
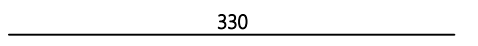
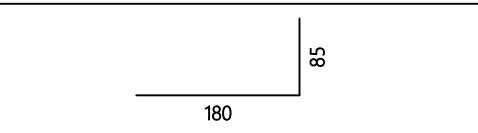
Šipke - specifikacija						
ozn	oblik i mjere [cm]	Ø	lg [m]	n [kom]	lgn [m]	Napomena
Armatura stropne ploče drugog kata (1 kom)						
601		20	12.00	2	24.00	
602		20	12.00	6	72.00	
603		20	12.00	4	48.00	
604		20	11.40	2	22.80	
605		20	11.40	4	45.60	
606		16	12.00	4	48.00	
607		16	12.00	6	72.00	
608		16	12.00	2	24.00	
609		16	10.70	4	42.80	
610		16	10.70	2	21.40	
611		16	3.50	48	168.00	
612		16	3.30	5	16.50	
613		16	2.65	16	42.40	

ISKAZ ARMATURE

GRAĐEVINA:	REKONSTRUKCIJA TERMALNOG REKREACIJSKOG CENTRA TERME TUHELJ		
ISKAZ UZ NACRT:	ARM_E2_601-603_0		
SADRŽAJ:	ARMATURA STROPNE PLOČE DRUGOG KATA		
DATUM:	svibanj, 2023.	2/11	

Šipke - specifikacija

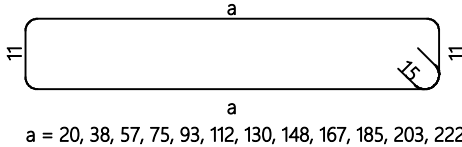
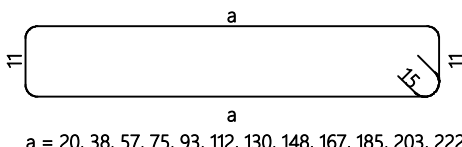
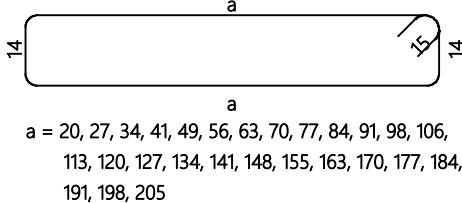

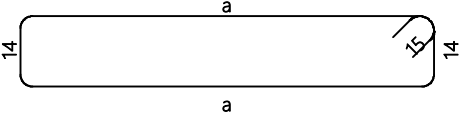
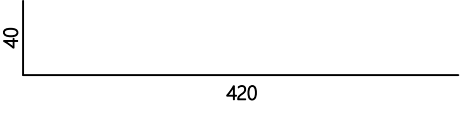
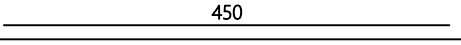
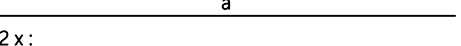
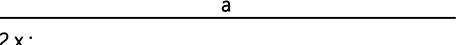
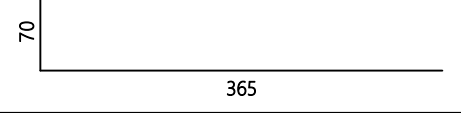
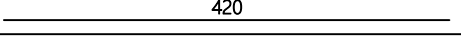
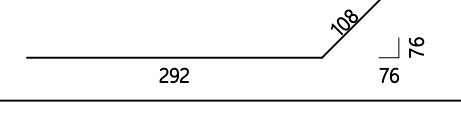
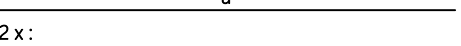
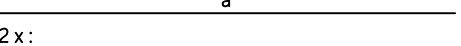
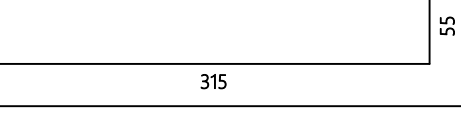
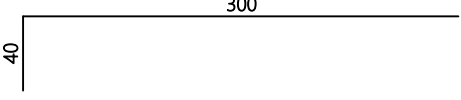

ozn	oblik i mjere [cm]	Ø	lg [m]	n [kom]	lgn [m]	Napomena
614	_____ 250 _____	16	2.50	15	37.50	
615	_____ 1200 _____	14	12.00	18	216.00	
616	_____ 1120 _____	14	11.20	12	134.40	
617	_____ 960 _____	14	9.60	4	38.40	
618	_____ 950 _____	14	9.50	6	57.00	
619	_____ 885 _____	14	8.85	4	35.40	
620	_____ 875 _____	14	8.75	12	105.00	
621	_____ 850 _____	14	8.50	4	34.00	
622	_____ 805 _____	14	8.05	8	64.40	
623	_____ 795 _____	14	7.95	12	95.40	
624	_____ 790 _____	14	7.90	4	31.60	
625	_____ 655 _____	14	6.55	8	52.40	
626	_____ 620 _____	14	6.20	4	24.80	
627	_____ 595 _____	14	5.95	4	23.80	
628	_____ 560 _____	14	5.60	4	22.40	
629	_____ 540 _____	14	5.40	4	21.60	
630	_____ 535 _____	14	5.35	10	53.50	
631	 a = 20, 38, 57, 75, 93, 112, 130, 148, 167, 185, 203, 222	14	*2.94	1 x 12	35.24	
632	 a = 20, 38, 57, 75, 93, 112, 130, 148, 167, 185, 203, 222	14	*2.94	1 x 12	35.24	
633	_____ 485 _____	14	4.85	4	19.40	
634	 a = 20, 27, 34, 41, 49, 56, 63, 70, 77, 84, 91, 98, 106, 113, 120, 127, 134, 141, 148, 155, 163, 170, 177, 184, 191, 198, 205	14	*2.83	1 x 27	76.50	

ISKAZ ARMATURE

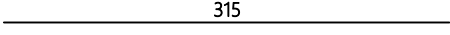
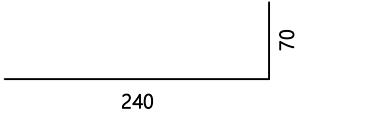

GRAĐEVINA:	REKONSTRUKCIJA TERMALNOG REKREACIJSKOG CENTRA TERME TUHELJ	
ISKAZ UZ NACRT:	ARM_E2_601-603_0	
SADRŽAJ:	ARMATURA STROPNE PLOČE DRUGOG KATA	
DATUM:	svibanj, 2023.	3/11

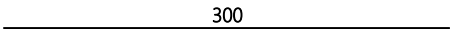
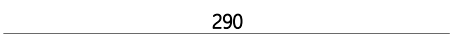
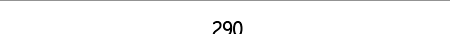
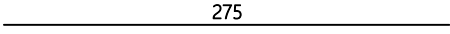
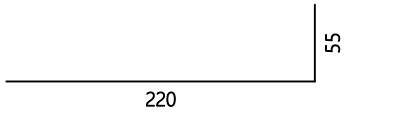
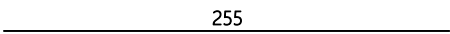
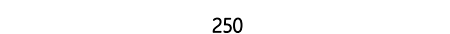
Šipke - specifikacija						
ozn	oblik i mjere [cm]	Ø	lg [m]	n [kom]	lgn [m]	Napomena
635	 <p>a = 20, 27, 34, 41, 49, 56, 63, 70, 77, 84, 91, 98, 106, 113, 120, 127, 134, 141, 148, 155, 163, 170, 177, 184, 191, 198, 205</p>	14	*2.83	1 x 27	76.50	
636		14	4.60	4	18.40	
637		14	4.50	2	9.00	
638	 <p>2 x : a = 70, 87, 104, 120, 137, 154, 171, 187, 204, 221, 238, 254, 271, 288, 305, 321, 338, 355, 372, 388, 405, 422, 439</p>	14	*2.54	2 x 23	117.02	
639	 <p>2 x : a = 70, 87, 104, 120, 137, 154, 171, 187, 204, 221, 238, 254, 271, 288, 305, 321, 338, 355, 372, 388, 405, 422, 439</p>	14	*2.54	2 x 23	117.02	
640		14	4.35	2	8.70	
641		14	4.20	8	33.60	
642		14	4.00	2	8.00	
643	 <p>2 x : a = 393, 380, 367, 354, 341, 328, 315, 301, 288, 275, 262, 249, 236, 223, 210</p>	14	*3.01	2 x 15	90.44	
644	 <p>2 x : a = 393, 380, 367, 354, 341, 328, 315, 301, 288, 275, 262, 249, 236, 223, 210</p>	14	*3.01	2 x 15	90.44	
645		14	3.70	18	66.60	
646		14	3.40	2	6.80	

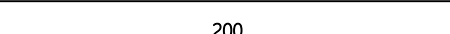
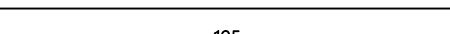
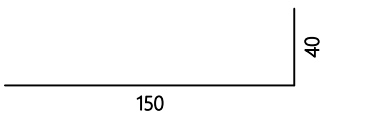
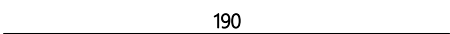
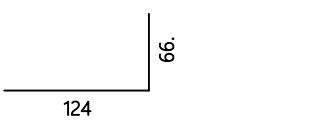
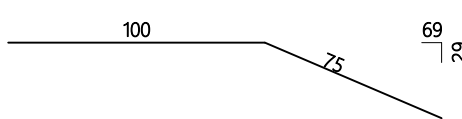
ISKAZ ARMATURE		
GRAĐEVINA:	REKONSTRUKCIJA TERMALNOG REKREACIJSKOG CENTRA TERME TUHELJ	
ISKAZ UZ NACRT:	ARM_E2_601-603_0	
SADRŽAJ:	ARMATURA STROPNE PLOČE DRUGOG KATA	
DATUM:	svibanj, 2023.	4/11

Šipke - specifikacija						
ozn	oblik i mjere [cm]	Ø	lg [m]	n [kom]	lgn [m]	Napomena
647		14	3.15	4	12.60	
648		14	3.10	2	6.20	
649		14	3.05	4	12.20	
650		14	3.00	99	297.00	
651		14	2.90	10	29.00	
652		14	2.90	6	17.40	
653		14	2.85	4	11.40	
654		14	2.75	8	22.00	
655		14	2.75	12	33.00	
656		14	2.55	8	20.40	
657		14	2.50	8	20.00	
658		14	2.15	2	4.30	
659		14	2.00	20	40.00	
660		14	1.95	28	54.60	
661		14	1.90	4	7.60	
662		14	1.90	2	3.80	
663		14	1.90	16	30.40	
664		14	1.75	8	14.00	

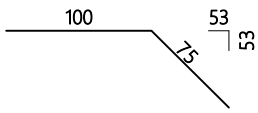
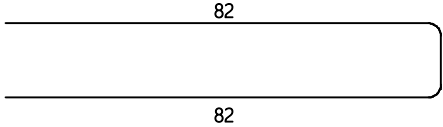
ISKAZ ARMATURE		
GRAĐEVINA:	REKONSTRUKCIJA TERMALNOG REKREACIJSKOG CENTRA TERME TUHELJ	
ISKAZ UZ NACRT:	ARM_E2_601-603_0	
SADRŽAJ:	ARMATURA STROPNE PLOČE DRUGOG KATA	
DATUM:	svibanj, 2023.	5/11

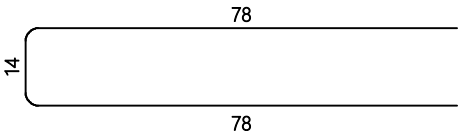
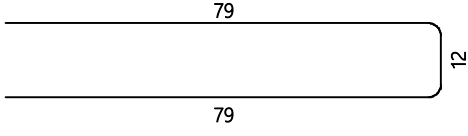
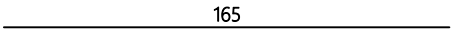
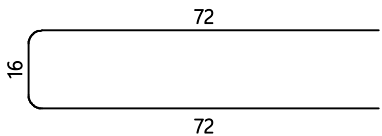
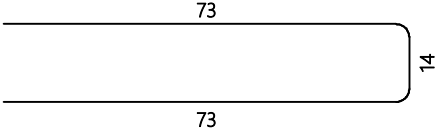
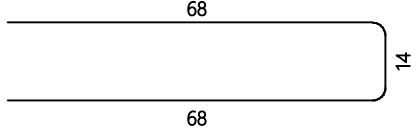
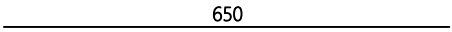
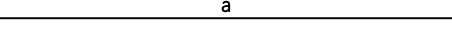
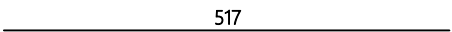
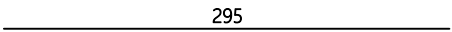

Šipke - specifikacija						
ozn	oblik i mjere [cm]	Ø	lg [m]	n [kom]	lgn [m]	Napomena
665		14	1.75	4	7.00	
666		14	1.75	46	80.50	
667		14	1.70	16	27.20	
668		14	1.70	60	102.00	
669		14	1.70	46	78.20	
670		14	1.65	4	6.60	
671		14	1.60	16	25.60	
672		14	1.60	30	48.00	
673		12	1.50	72	108.00	
674		10	6.50	46	299.00	
675	 2 x : a = 550, 537, 523, 510, 496, 483, 469	10	*5.10	2 x 7	71.36	
676		10	5.17	14	72.38	
677		10	2.95	41	120.95	

ISKAZ ARMATURE

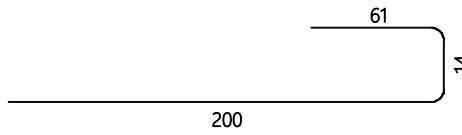
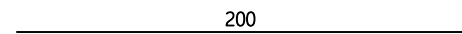
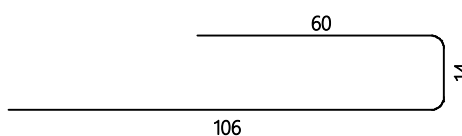
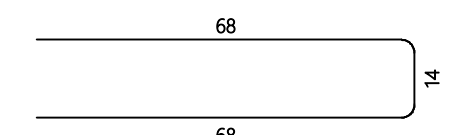
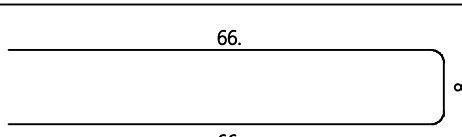
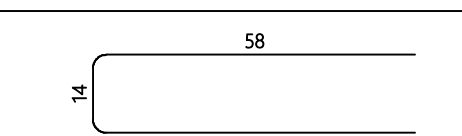
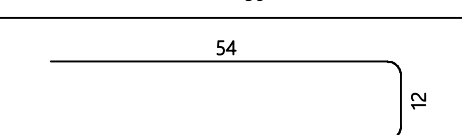
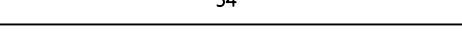
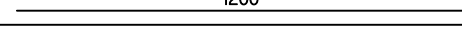
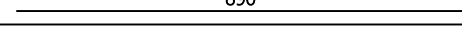
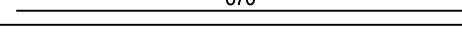
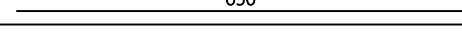
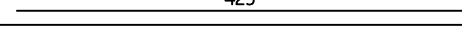
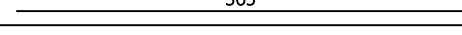
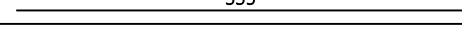
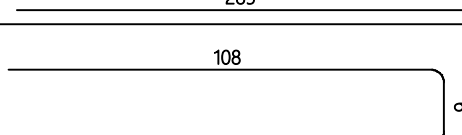
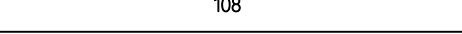
GRAĐEVINA:	REKONSTRUKCIJA TERMALNOG REKREACIJSKOG CENTRA TERME TUHELJ	
ISKAZ UZ NACRT:	ARM_E2_601-603_0	
SADRŽAJ:	ARMATURA STROPNE PLOČE DRUGOG KATA	
DATUM:	svibanj, 2023.	6/11

Šipke - specifikacija						
ozn	oblik i mjere [cm]	Ø	lg [m]	n [kom]	lgn [m]	Napomena
678		10	2.75	35	96.25	
679		10	2.00	320	640.00	
680		10	1.80	86	154.80	
681		10	1.50	208	312.00	
682		10	1.40	28	39.20	
683		10	1.30	30	39.00	
684		10	1.20	432	518.40	
685		8	12.00	12	144.00	
686		8	8.90	6	53.40	
687		8	6.70	96	643.20	
688		8	6.50	46	299.00	
689		8	4.25	3	12.75	
690		8	3.65	8	29.20	
691		8	3.35	3	10.05	
692		8	2.85	28	79.80	
693		8	2.25	30	67.50	
694		8	2.15	51	109.65	

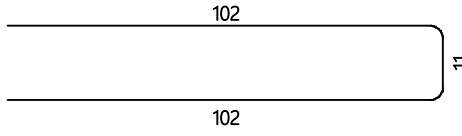
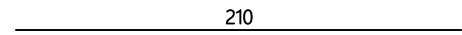
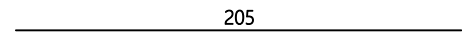
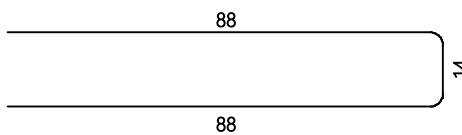
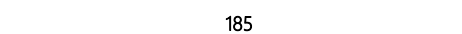
ISKAZ ARMATURE		
GRAĐEVINA:	REKONSTRUKCIJA TERMALNOG REKREACIJSKOG CENTRA TERME TUHELJ	
ISKAZ UZ NACRT:	ARM_E2_601-603_0	
SADRŽAJ:	ARMATURA STROPNE PLOČE DRUGOG KATA	
DATUM:	svibanj, 2023.	7/11

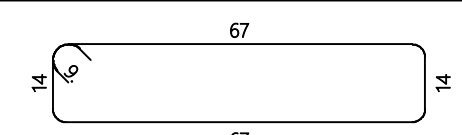
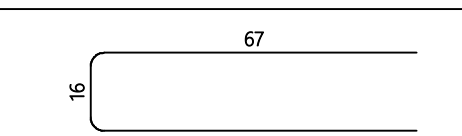
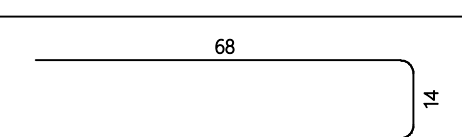
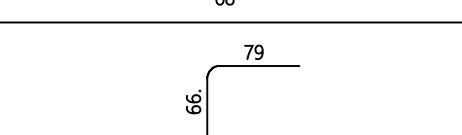
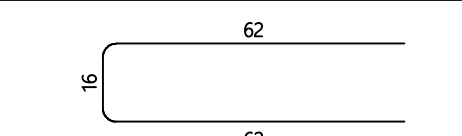
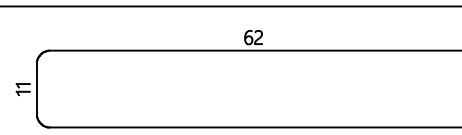
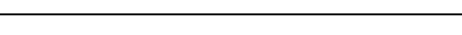
Šipke - specifikacija						
ozn	oblik i mjere [cm]	Ø	lg [m]	n [kom]	lgn [m]	Napomena
695		8	2.15	6	12.90	
696		8	2.10	6	12.60	
697		8	2.05	6	12.30	
698		8	1.90	26	49.40	
699		8	1.85	12	22.20	
700		8	1.85	17	31.45	
701		8	1.80	208	374.40	
702		8	1.50	24	36.00	
703		8	1.50	18	27.00	
704		8	1.45	90	130.50	
705		8	1.40	64	89.60	
706		8	1.35	16	21.60	
707		8	1.30	27	35.10	

ISKAZ ARMATURE

GRAĐEVINA:	REKONSTRUKCIJA TERMALNOG REKREACIJSKOG CENTRA TERME TUHELJ	
ISKAZ UZ NACRT:	ARM_E2_601-603_0	
SADRŽAJ:	ARMATURA STROPNE PLOČE DRUGOG KATA	
DATUM:	svibanj, 2023.	8/11

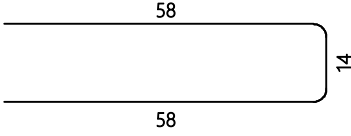
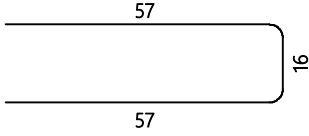
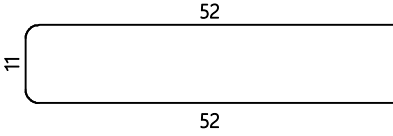
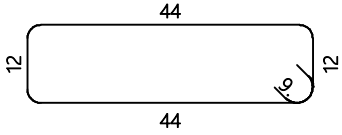
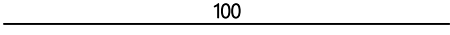
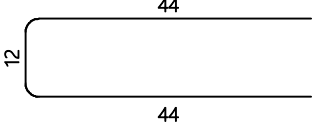
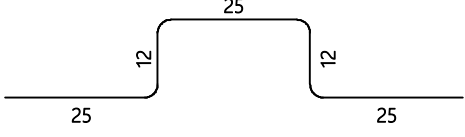
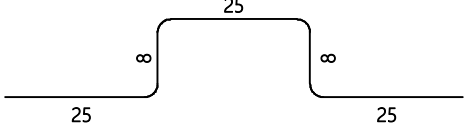
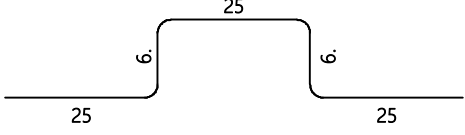
Šipke - specifikacija						
ozn	oblik i mjere [cm]	Ø	lg [m]	n [kom]	lgn [m]	Napomena
708		8	1.30	430	559.00	
709		8	1.30	341	443.30	
710		8	1.15	3	3.45	
711		8	1.30	52	67.60	
712		8	1.00	630	630.00	
713		8	1.00	6	6.00	
714		8	0.99	760	752.40	
715		8	0.91	128	116.48	
716		8	0.87	36	31.32	

ISKAZ ARMATURE		
GRAĐEVINA:	REKONSTRUKCIJA TERMALNOG REKREACIJSKOG CENTRA TERME TUHELJ	
ISKAZ UZ NACRT:	ARM_E2_601-603_0	
SADRŽAJ:	ARMATURA STROPNE PLOČE DRUGOG KATA	
DATUM:	svibanj, 2023.	9/11

Šipke - rekapitulacija			
Ø [mm]	lgn [m]	Jedinična težina [kg/m ¹]	Težina [kg]
B500B			
8	4913.15	0.40	1940.69
10	2363.34	0.62	1458.18
12	108.00	0.89	95.90
14	2830.00	1.21	3424.30
16	472.60	1.58	746.71
20	212.40	2.47	524.63
Ukupno (B500B)			8190.42
Ukupno			8190.42

ISKAZ ARMATURE		
GRAĐEVINA:	REKONSTRUKCIJA TERMALNOG REKREACIJSKOG CENTRA TERME TUHELJ	
ISKAZ UZ NACRT:	ARM_E2_601-603_0	
SADRŽAJ:	ARMATURA STROPNE PLOČE DRUGOG KATA	
DATUM:	svibanj, 2023.	10/11

Mreže - specifikacija							
Pozicija	Oznaka mreže	B [cm]	L [cm]	n	Jedinična težina [kg/m ²]	Ukupna težina [kg]	Napomena
Armatura stropne ploče drugog kata (1 kom)							
1	Q-335	215	600	20	5.38	1388.04	
1-1	Q-335	190	300	1	5.38	30.67	
1-2	Q-335	190	600	1	5.38	61.33	
1-3	Q-335	190	300	1	5.38	30.66	
1-4	Q-335	215	330	4	5.38	152.68	
1-5	Q-335	120	330	1	5.38	21.31	
1-6	Q-335	190	441	1	5.38	45.03	
1-7	Q-335	190	600	1	5.38	61.33	
1-8	Q-335	190	441	1	5.38	45.03	
1-9	Q-335	215	155	2	5.38	35.86	
1-10	Q-335	215	245	16	5.38	453.43	
1-11	Q-335	110	600	4	5.38	142.03	
1-12	Q-335	110	245	4	5.38	58.00	
1-13	Q-335	215	105	2	5.38	24.29	
1-17	Q-335	170	570	2	5.38	104.26	
1-19	Q-335	215	600	2	5.38	138.80	
1-20	Q-335	215	155	2	5.38	35.86	
1-21	Q-335	90	437	2	5.38	42.29	
2	Q-257	215	600	6	4.12	318.89	
2-1	Q-257	178	600	2	4.12	87.76	
2-2	Q-257	103	190	1	4.12	8.02	
2-3	Q-257	215	235	11	4.12	228.98	
2-4	Q-257	215	600	13	4.12	690.92	
2-5	Q-257	82	190	1	4.12	6.46	
2-6	Q-257	202	235	1	4.12	19.61	
2-7	Q-257	215	190	1	4.12	16.83	
2-8	Q-257	202	235	1	4.12	19.60	
2-9	Q-257	82	190	1	4.12	6.46	
2-10	Q-257	215	185	1	4.12	16.39	
2-11	Q-257	173	190	1	4.12	13.54	
2-12	Q-257	190	600	4	4.12	187.87	
2-13	Q-257	168	145	2	4.12	20.10	
2-14	Q-257	215	385	2	4.12	68.21	
2-15	Q-257	215	330	2	4.12	58.46	
2-16	Q-257	120	385	1	4.12	19.03	
2-17	Q-257	170	570	2	4.12	79.85	
2-18	Q-257	215	485	2	4.12	86.00	

ISKAZ ARMATURE		
GRAĐEVINA:	REKONSTRUKCIJA TERMALNOG REKREACIJSKOG CENTRA TERME TUHELJ	
ISKAZ UZ NACRT:	ARM_E2_601-603_0	
SADRŽAJ:	ARMATURA STROPNE PLOČE DRUGOG KATA	
DATUM:	svibanj, 2023.	11/11

Mreže - specifikacija							
Polozicija	Oznaka mreže	B [cm]	L [cm]	n	Jedinična težina [kg/m ²]	Ukupna težina [kg]	Napomena
2-19	Q-257	215	557	2	4.12	98.68	
2-20	Q-257	200	600	2	4.12	98.88	
3-1	Q-524	115	600	10	8.31	573.39	
3-2	Q-524	115	435	2	8.31	83.14	
Ukupno						5677.97	

1 KROVNA PLOČA SMJEŠTAINOG PAVILIONA
NACRT SAVIJANJA ARMATURE DONJE ZONE
M 1:50

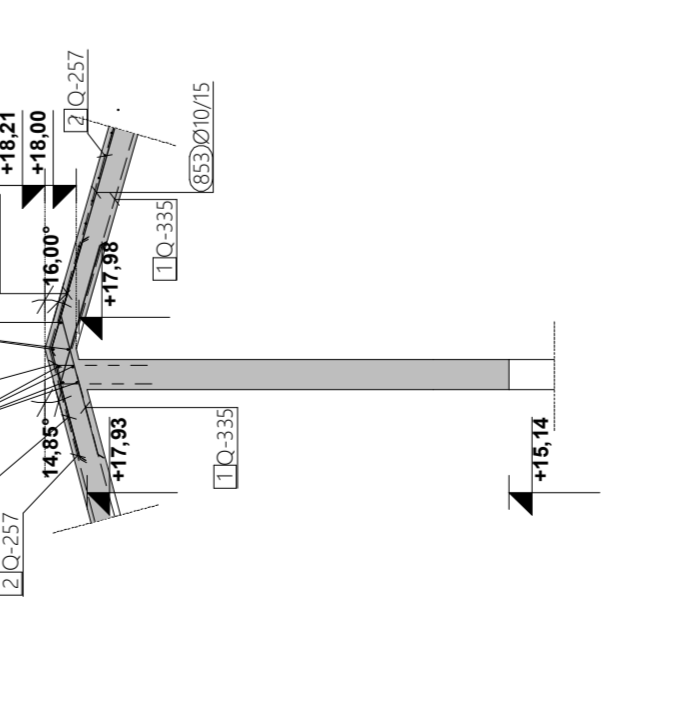
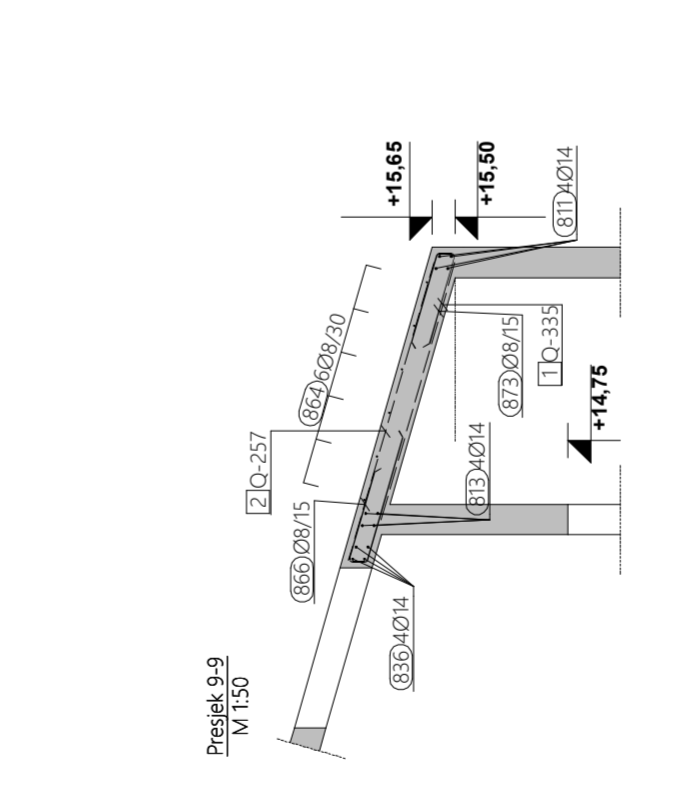
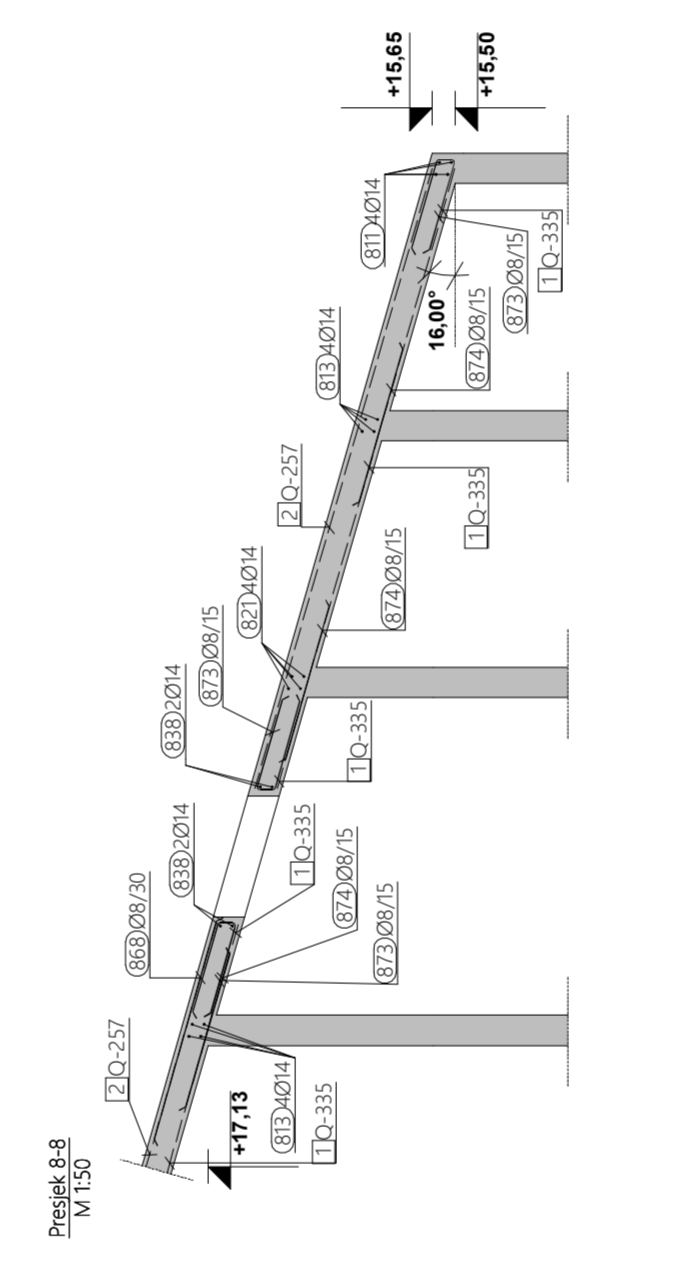
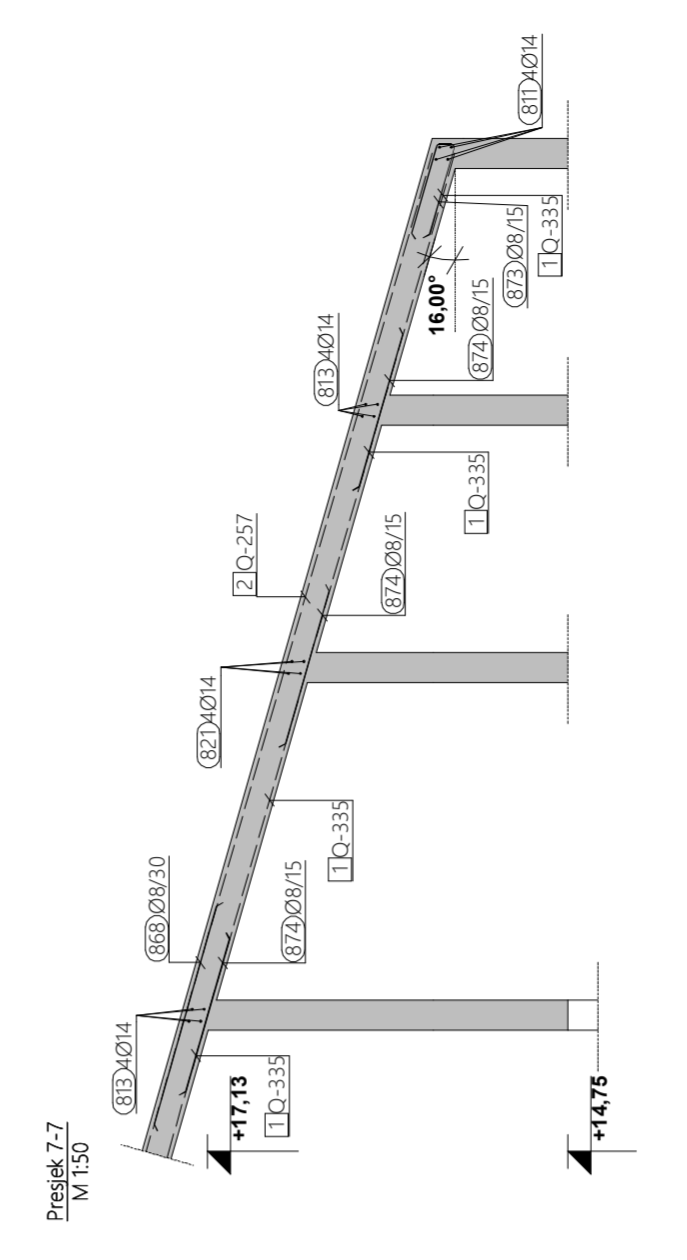
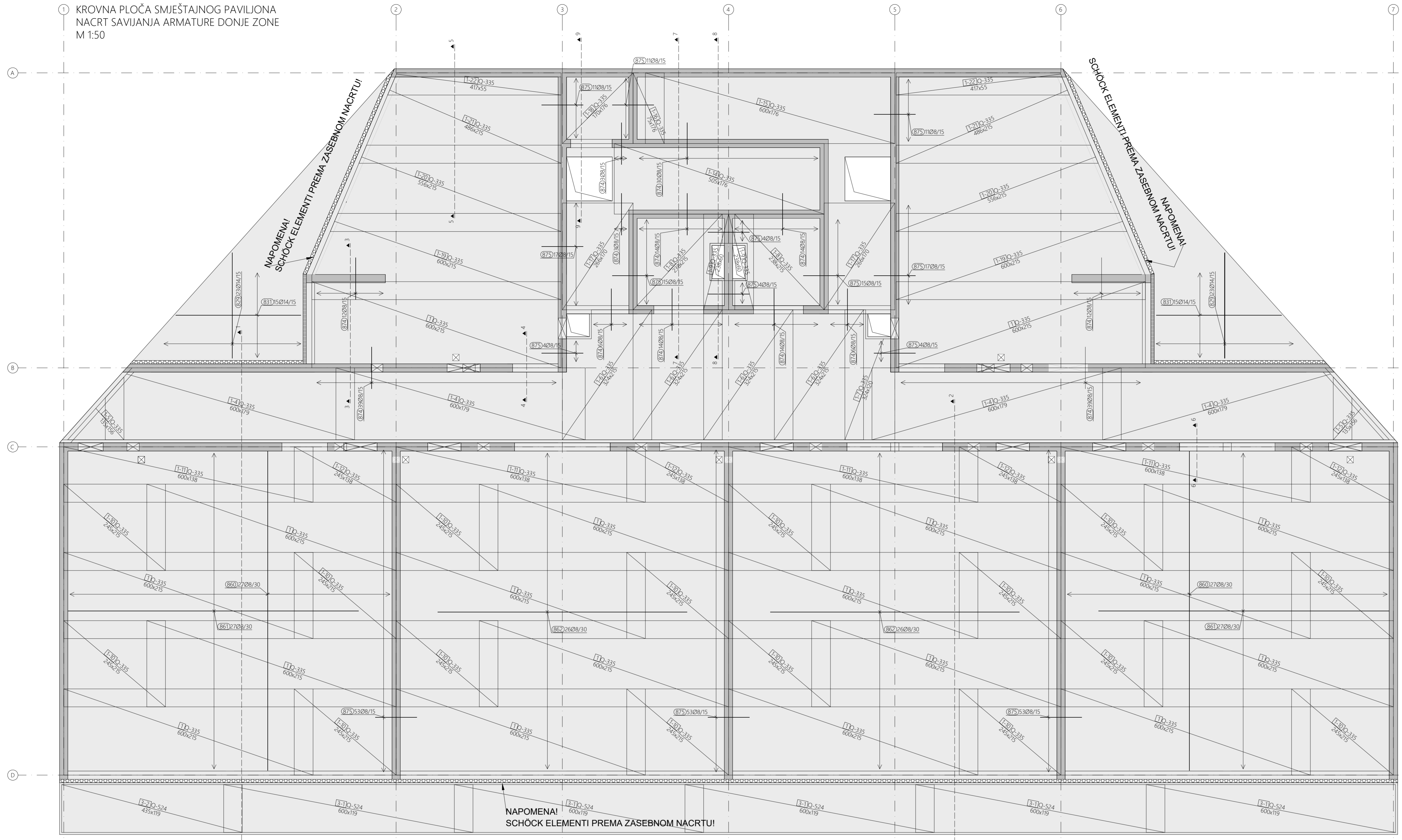

Šipke - specifikacija

ozn.	ozn. i mjere (cm)	Ø (mm)	l (m)	n (kom)	ign (m)
Armatura krovne ploče (1 kom)					
801	1335	20	12,00	2	24,00
802	1070	20	12,00	6	72,00
803	1005	20	12,00	4	48,00
804	945	20	11,40	2	22,80
805	1075	20	11,40	4	45,60
806	1150	16	12,00	4	48,00
807	1002	16	12,00	6	72,00
808	1052	16	12,00	2	24,00
809	922	16	10,70	4	42,80
810	1030	16	10,70	2	21,40
811	1200	14	12,00	26	312,00
812	1199	14	11,30	8	90,40
813	960	14	9,60	8	76,80
814	950	14	9,50	10	95,00
815	905	14	9,05	1	9,05
816	885	14	8,85	4	35,40
817	850	14	8,50	4	34,00
818	840	14	8,40	20	168,00
819	825	14	8,25	8	66,00
820	880	14	6,80	4	27,20
821	620	14	6,20	4	24,80
822	580	14	5,80	4	23,20
823	560	14	5,60	4	22,40
824	540	14	5,40	4	21,60
825	535	14	5,35	8	42,80
826	a	14	2*94	2 x 12	70,48
a = 20, 38, 57, 75, 93, 112, 130, 148, 167, 185, 203, 222					
827	a	14	4,85	4	19,40
828	a	14	2*89	2 x 27	153,00
a = 20, 27, 34, 41, 49, 56, 63, 70, 77, 84, 91, 98, 106, 113, 120, 127, 134, 141, 148, 155, 163, 170, 177, 184, 191, 198, 205					
829	a	14	2*54	4 x 23	234,04
a = 70, 87, 104, 120, 137, 154, 171, 187, 204, 221, 238, 254, 271, 288, 305, 321, 338, 355, 372, 388, 405, 422, 439					
830	a	14	4,00	8	32,00
831	a	14	3*01	4 x 15	180,88
a = 381, 380, 367, 354, 341, 328, 315, 301, 288, 275, 262, 249, 236, 223, 210					
832	340	14	3,40	8	27,20
833	330	14	3,30	8	26,40
834	320	14	3,20	8	25,60
835	305	14	3,05	8	24,40
836	275	14	2,75	8	22,00
837	255	14	2,55	8	20,40
838	230	14	2,30	4	9,20
839	220	14	2,20	8	17,60
840	100	14	2,00	8	16,00
841	93	14	2,00	60	120,00

842	92	14	1,95	44	85,80
843	90	14	1,90	8	15,20
844	79	14	1,70	46	78,20
845	78	14	1,70	18	30,60
846	76	14	1,65	16	26,40
847	77	14	1,65	16	26,40
848	400	12	4,00	154	624,00
849	340	12	3,40	20	68,00
850	a	10	5*10	2 x 7	71,36
a = 550, 537, 523, 510, 496, 483, 469					
851	517	10	5,17	14	72,38
852	220	10	2,20	20	44,00
853	200	10	2,00	272	544,00
854	190	10	1,90	56	106,40
855	71	10	1,55	208	322,40
856	57	10	1,25	215	268,75
857	54	10	1,20	215	258,00
858	53	10	1,20	18	21,60
859	1200	8	12,00	20	240,00
860	890	8	8,90	10	89,00
861	795	8	7,95	54	429,30
862	700	8	7,00	54	378,00
863	600	8	6,00	52	312,00
864	588	8	5,88	208	551,20
865	200	8	2,00	77	154,00
866	79	8	1,70	26	44,20
867	62	8	1,60	16	25,60
868	74	8	1,60	16	25,60
869	150	8	1,50	15	22,50
870	68	8	1,50	88	132,00
871	64	8	1,50	215	322,50
872	95	8	1,45	430	623,50
873	63	8	1,40	188	263,20
874	62	8	1,35	173	233,55
875	61	8	1,35	206	266,30
876	100	8	1,00	272	272,00
877	44	8	1,00	10	10,00
878	25	8	0,95	528	881,60
879	25	8	0,91	48	43,68

NAPOMENA
Šipke prilagoditi i po potrebi reziati na licu mjesta. Preklap 50Z.

NAPOMENA
Sve dimenzije provjeriti prema važećim planovima oplate.

Klasa betona	C 25/30
Armatura	B 500 B
Zaštitni sloj betona	
dolje	3,0 cm
gore	3,0 cm
bočno	3,0 cm
Pripadajući isos armature	ARM_E3_601-603_JSKAZ
Pripadajući armaturni nacrti	ARM_E3_602-603

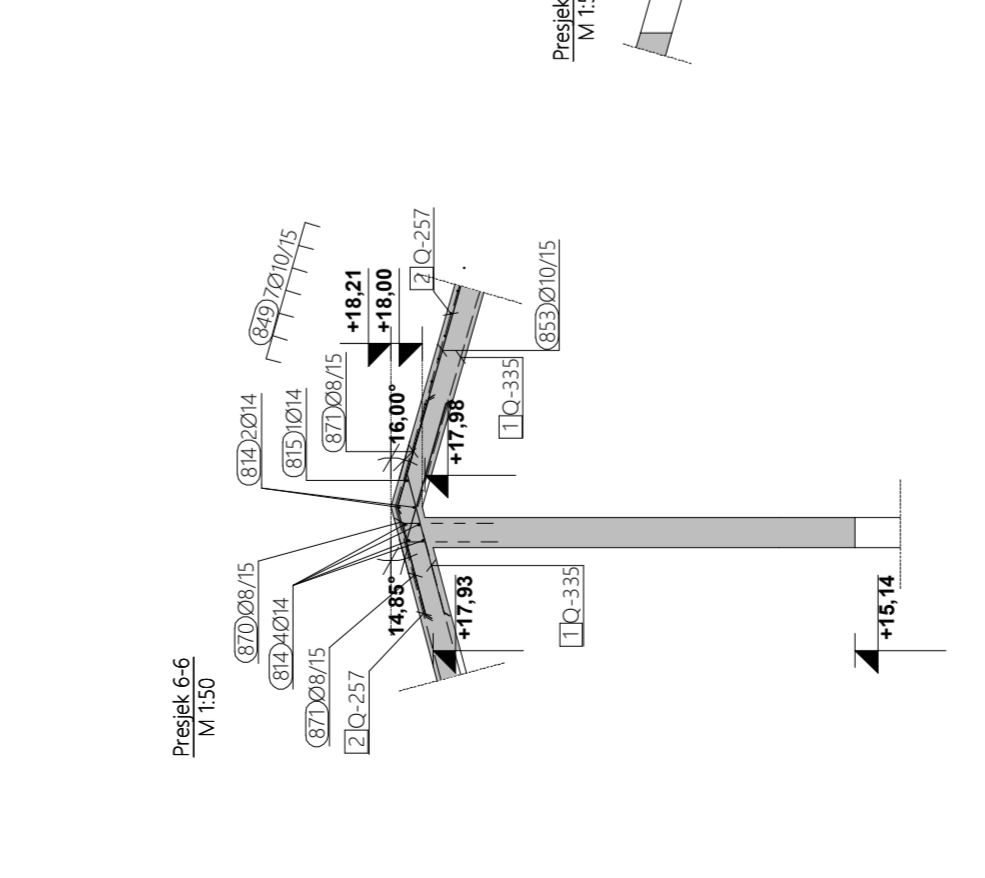
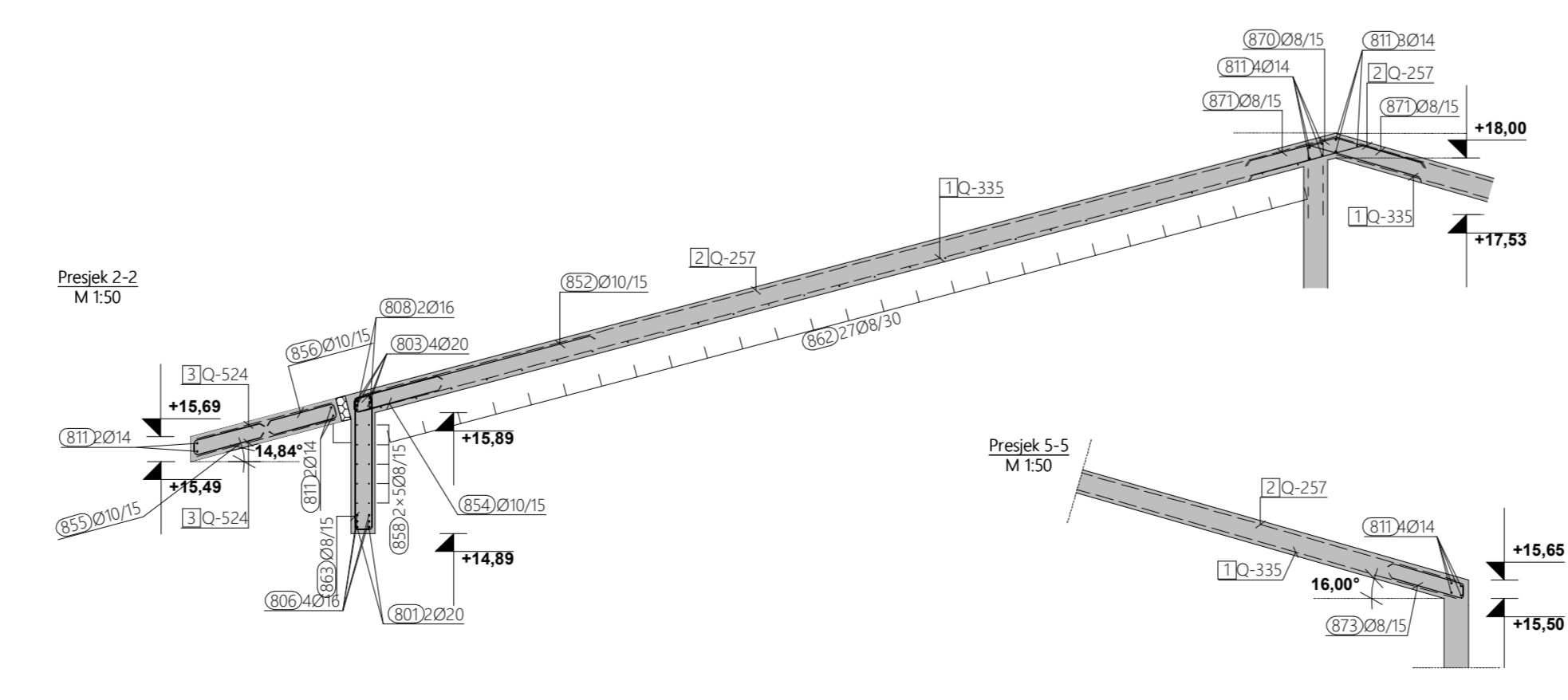
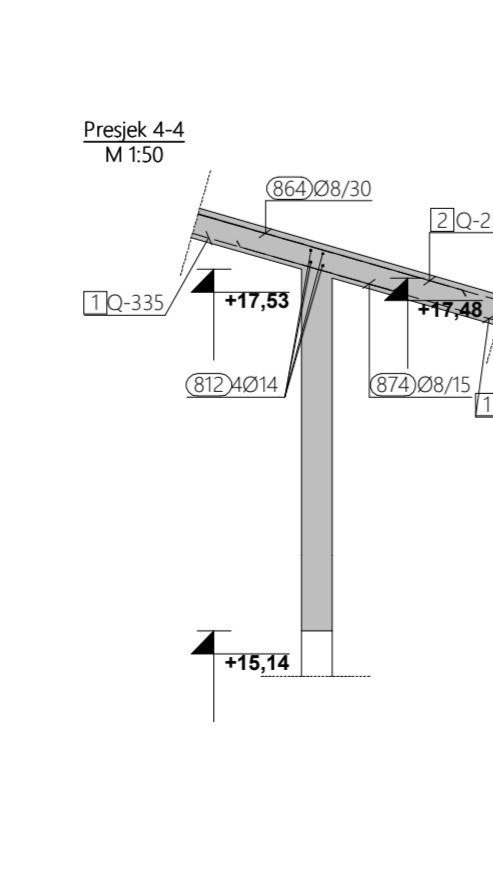
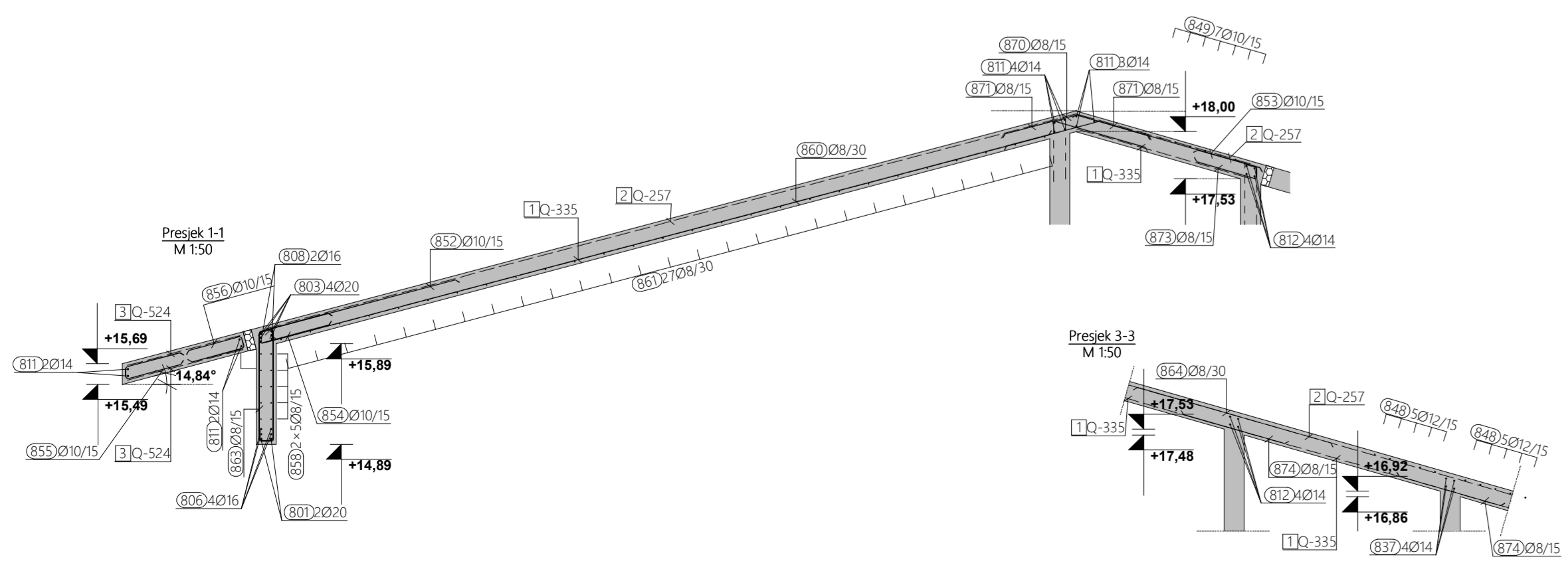

JAHAČI - 2 KOM / m²
PLOČA d=20 cm

JAHAČI - 2 KOM / m²
PLOČA d=20 cm

KONSTRUKTA PEČAT I POTPIS:

KONSTRUKTA d.o.o. za projektiranje i nadzor
Desnička 20, ZAGREB, OIB: 06674378579
Zr: PRIVREDNA BANKA 2340009-1110164468
TEL: 0136 43 525; FAX: 0136 43 829
MAIL: info@konstrukt.hr

INVESTITOR: TERME TUHELJI d.o.o. Ujediniča Gata 4, Tuhejske Toplice, 49275 Tuhej

GRAĐEVINA: REKONSTRUKCIJA TERMALNOG REKREACIJSKOG CENTRA TERME TUHELJI

LOKACIJA: na k.č.br. 3199/1, k.o. Črešnjevec

FAZA: IZVEDBENI PROJEKT - ARMATURNI NACRTI

SADRŽAJ: ELEMENT - SMJEŠTAINI PAVILION ARMATURA KROVNE PLOČE DONJA ZONA

GL. PROJEKTANT: Tomislav Vrh, dipl. ing. arh.

PROJEKT. IZV. PR: Antonio Maglov, dipl. ing. grad.

IZRADIO: Antonio Maglov, dipl. ing. grad.

DATUM: srpanj 2023.

MJESECI: 150

REVIZIJU: 09

NACRT BR: **ARM - E3 - 601**

KROVNA PLOČA SMJEŠTAJNOG PAVILJONA
 NACRT SAVIJANJA ARMATURE GORNJE ZONE
 M 1:50

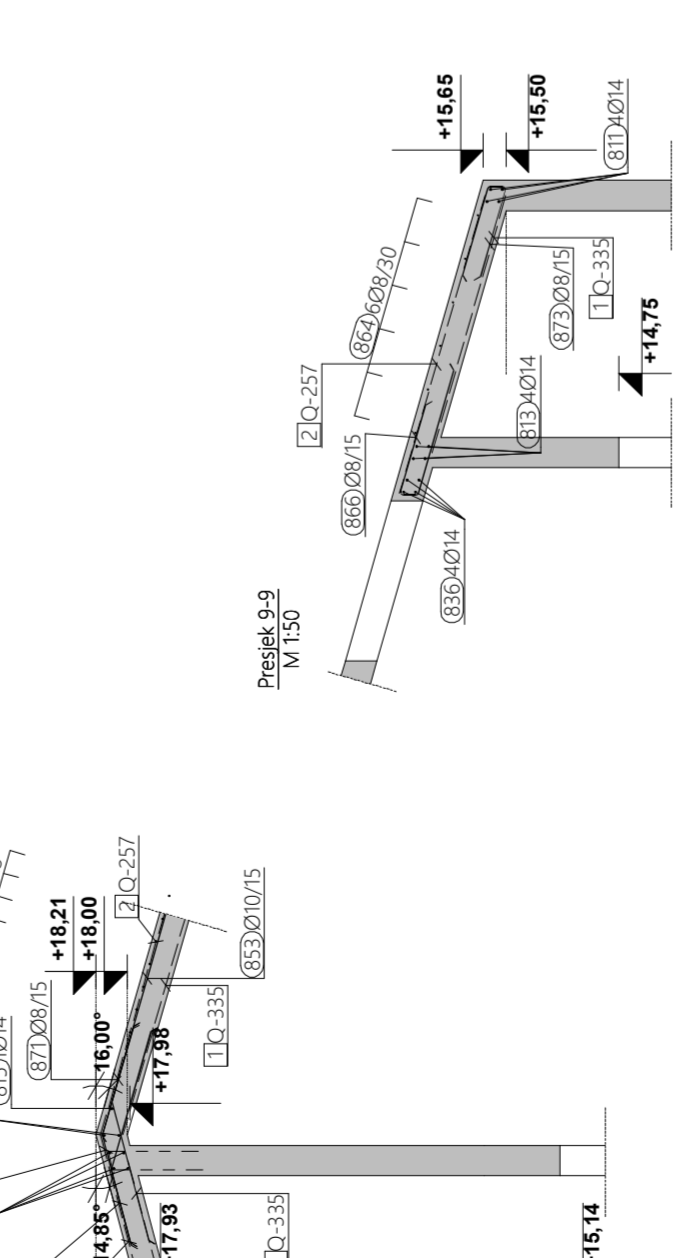
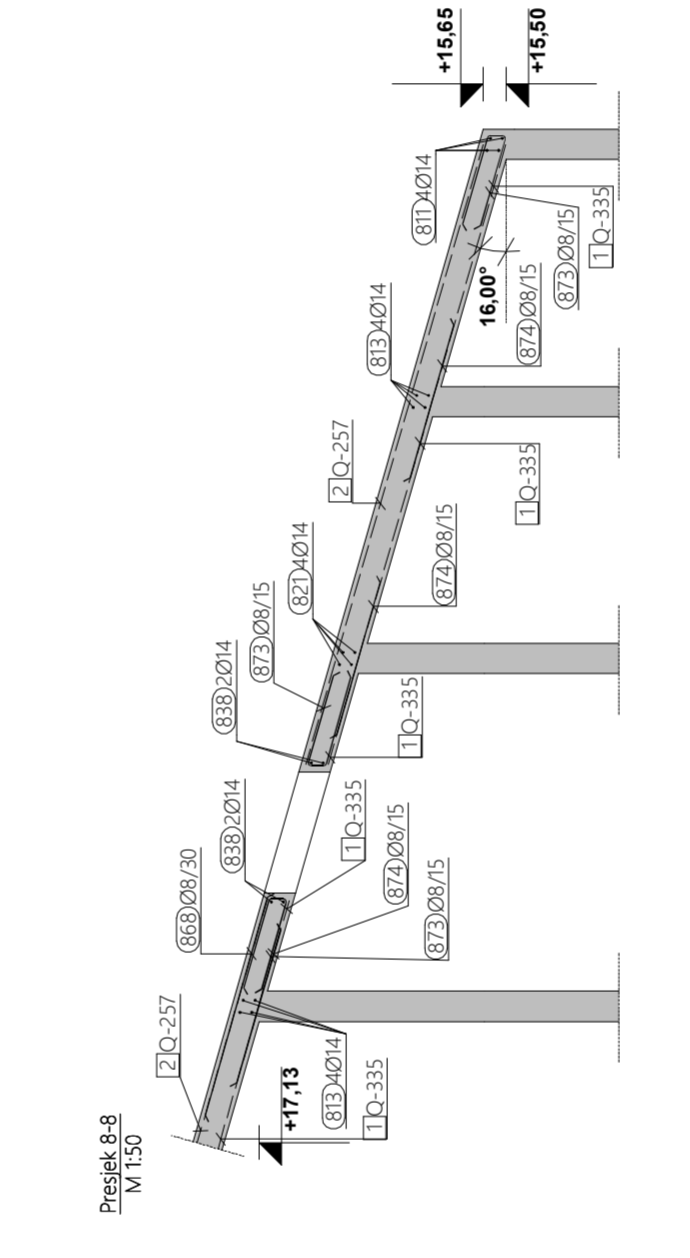
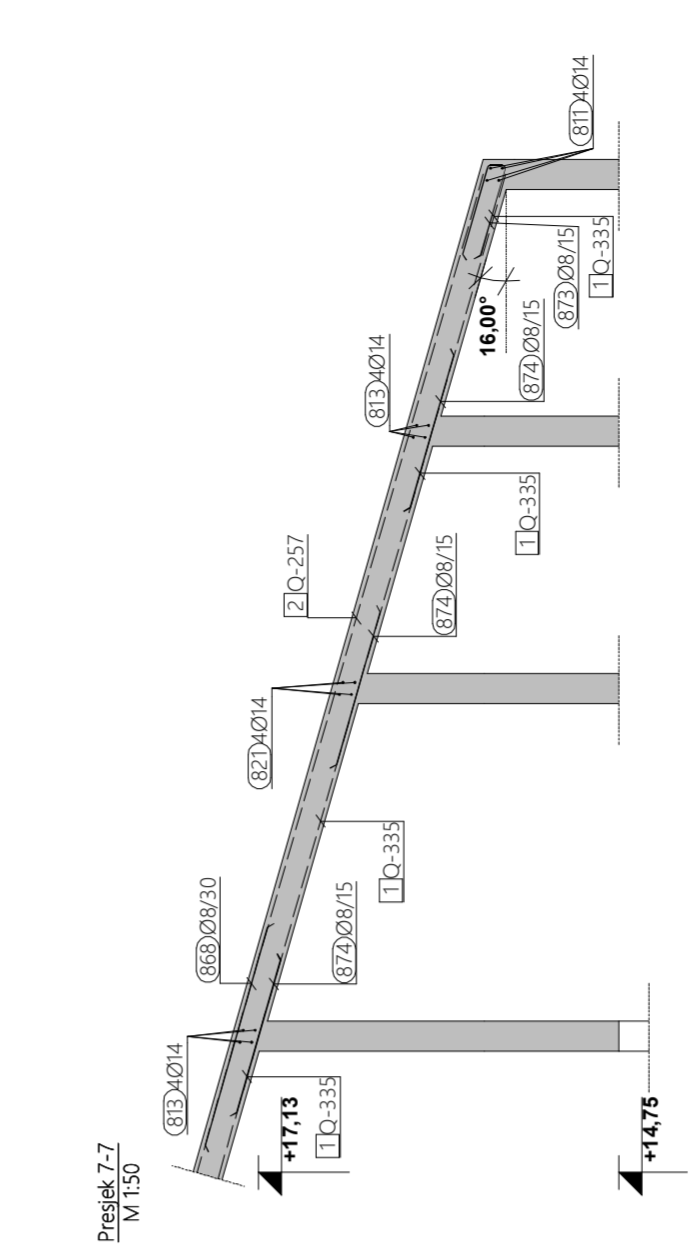
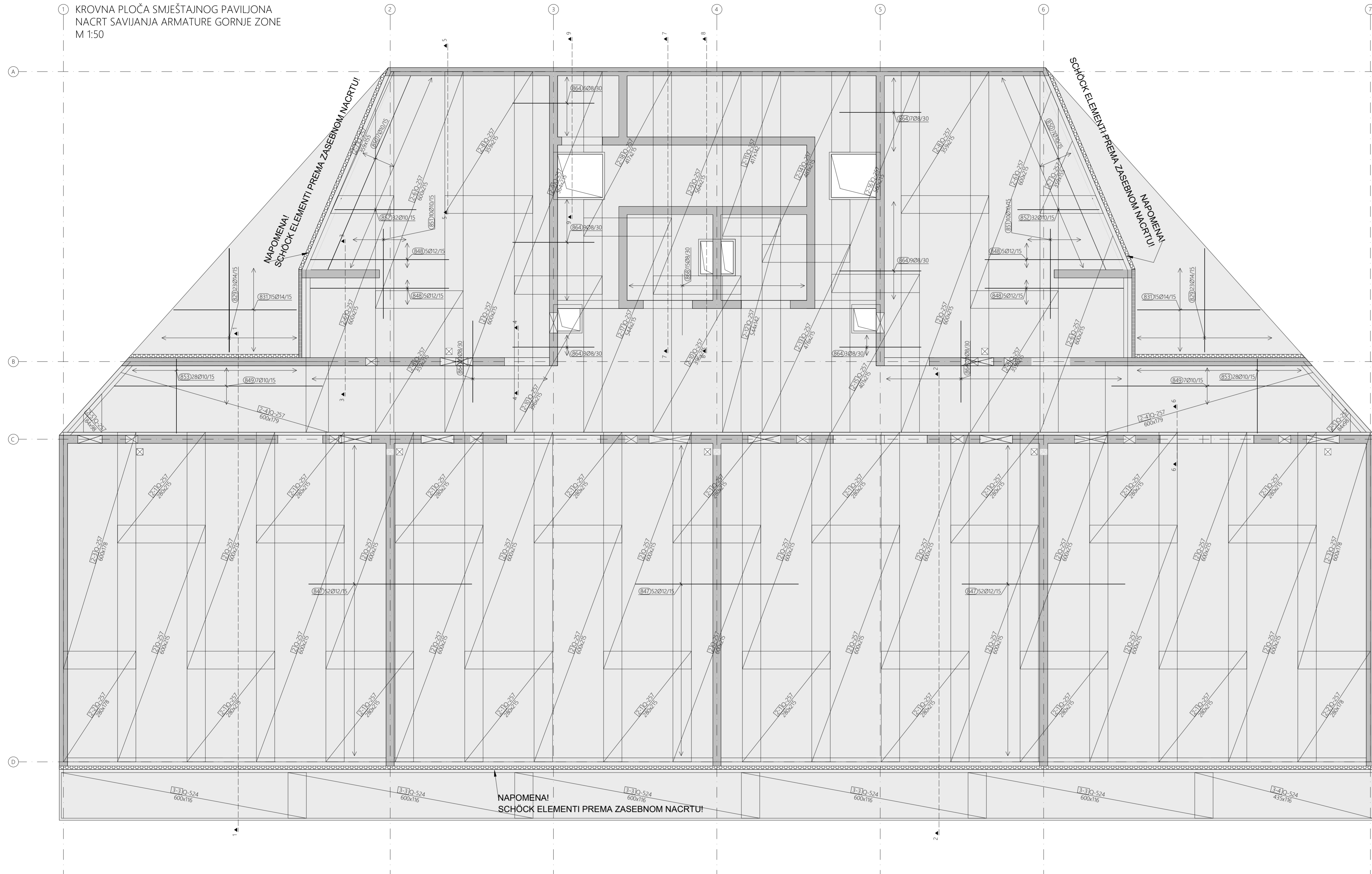

Šipke - specifikacija				
ozn.	odlik. i mjere (cm)	Ø (mm)	l (m)	n (kom)
Armatura krovne ploče (1 kom)				
801	1335	20	12.00	2
802	1070	20	12.00	6
803	1005	20	12.00	4
804	945	20	11.40	2
805	1075	16	11.40	4
806	1150	16	12.00	4
807	1002	16	12.00	6
808	1052	16	12.00	2
809	922	16	10.70	4
810	1000	16	10.70	2
811	1200	14	12.00	26
812	1190	14	11.30	8
813	960	14	9.60	8
814	950	14	9.50	10
815	905	14	9.05	1
816	885	14	8.85	4
817	850	14	8.50	4
818	840	14	8.40	20
819	825	14	8.25	8
820	880	14	6.80	4
821	620	14	6.20	4
822	580	14	5.80	4
823	560	14	5.60	4
824	540	14	5.40	4
825	535	14	5.35	8
826	a	14	*2.94	2 x 12
2 x: a = 20, 38, 57, 75, 93, 112, 130, 148, 167, 185, 203, 222				
827	a	14	4.85	4
828	a	14	*2.83	2 x 27
2 x: a = 20, 27, 34, 41, 49, 56, 63, 70, 77, 84, 91, 98, 106, 113, 120, 127, 134, 141, 148, 155, 163, 170, 177, 184, 191, 198, 205				
829	a	14	*2.54	4 x 23
4 x: a = 70, 87, 104, 120, 137, 154, 171, 187, 204, 221, 238, 254, 271, 288, 305, 321, 338, 355, 372, 388, 405, 422, 439				
830	a	14	4.00	8
831	a	14	*3.01	4 x 15
4 x: a = 393, 380, 367, 354, 341, 328, 315, 301, 288, 275, 262, 249, 236, 223, 210				
832	340	14	3.40	8
833	330	14	3.30	8
834	320	14	3.20	8
835	305	14	3.05	8
836	275	14	2.75	8
837	255	14	2.55	8
838	230	14	2.30	4
839	220	14	2.20	8
840	100	14	2.00	8
841	93	14	2.00	60

842	92	14	1.95	44
843	90	14	1.90	8
844	79	14	1.70	46
845	78	14	1.70	18
846	76	14	1.65	16
847	400	12	4.00	154
848	340	12	3.40	20
849	a	10	*5.10	2 x 7
2 x: a = 550, 537, 523, 510, 496, 483, 469				
850	517	10	5.17	14
851	220	10	2.20	20
852	200	10	2.00	272
853	190	10	1.90	56
854	71	10	1.55	208
855	57	10	1.25	215
856	54	10	1.20	215
857	53	10	1.20	18
858	1200	8	12.00	20
859	890	8	8.90	10
860	795	8	7.95	54
861	700	8	7.00	54
862	600	8	6.00	52
863	111	8	2.65	208
864	200	8	2.00	77
865	79	8	1.70	26
866	62	8	1.60	16
867	74	8	1.60	16
868	150	8	1.50	15
869	68	8	1.50	88
870	64	8	1.50	215
871	95	8	1.45	430
872	63	8	1.40	188
873	62	8	1.35	173
874	105	8	1.05	216
875	100	8	1.00	272
876	44	8	1.00	10
877	25	8	0.95	528
878	25	8	0.91	48

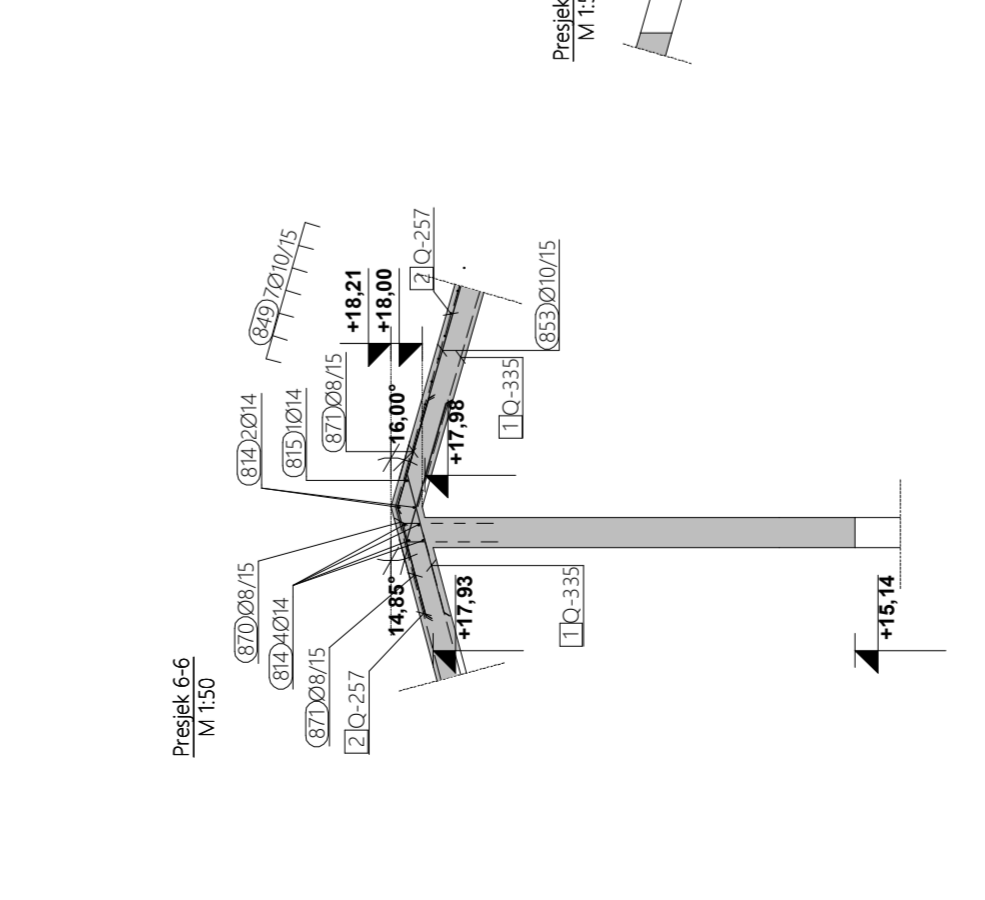
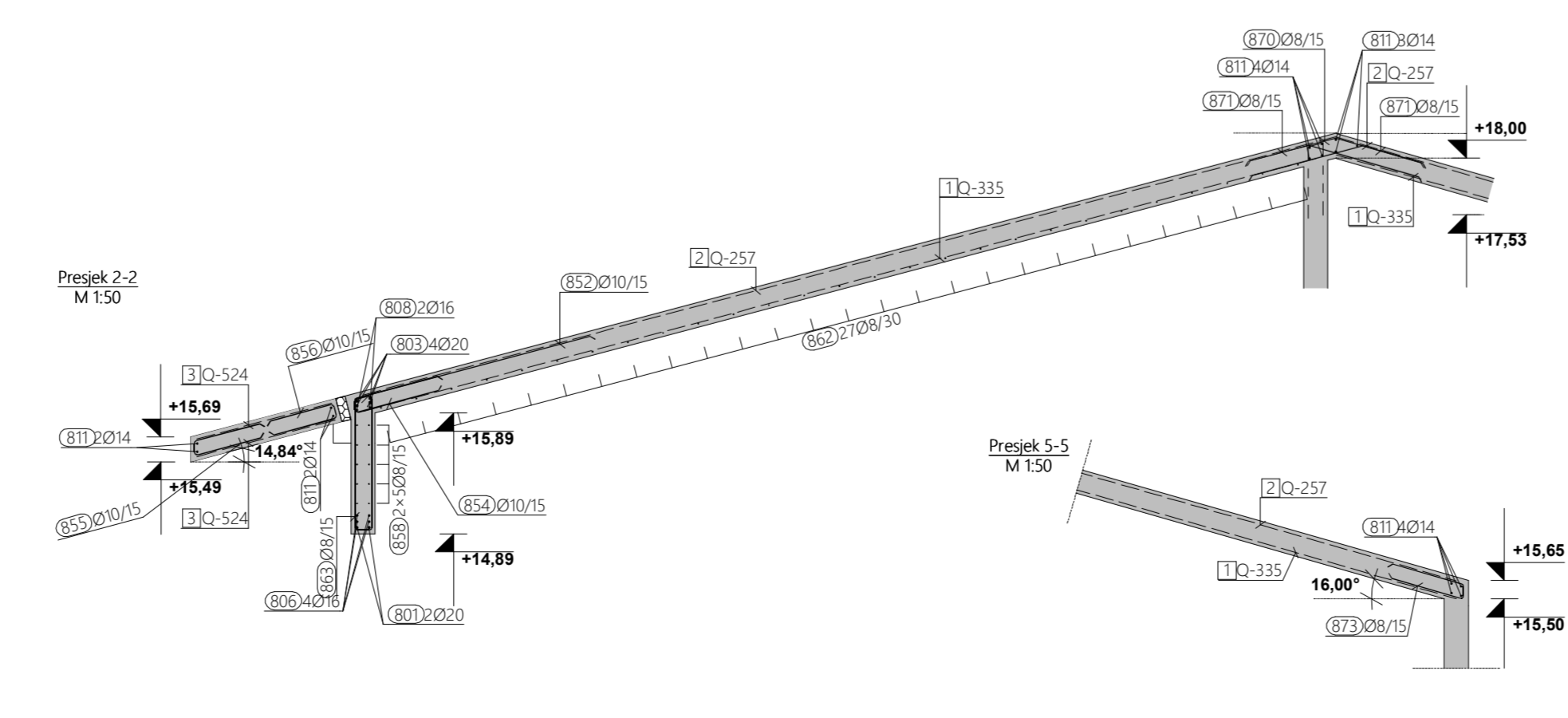
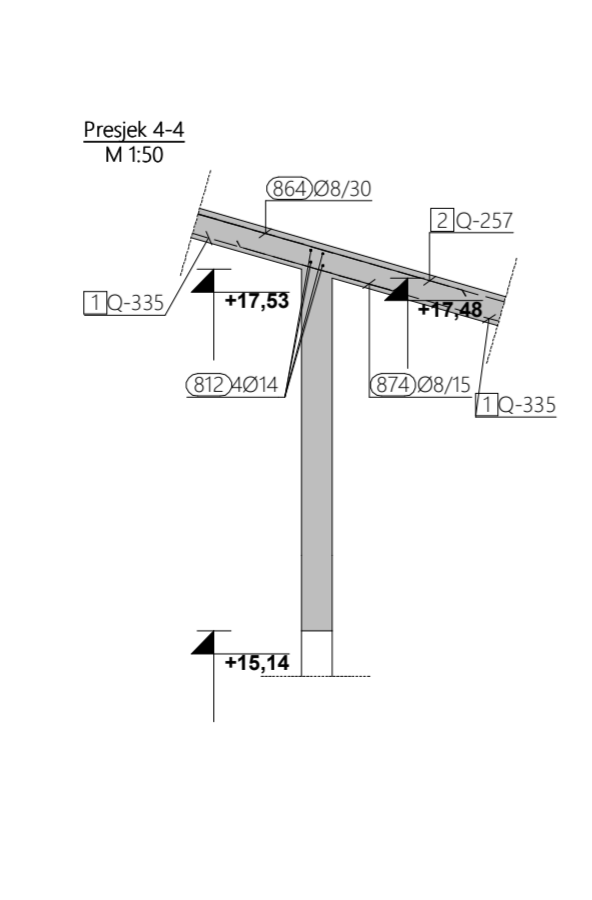
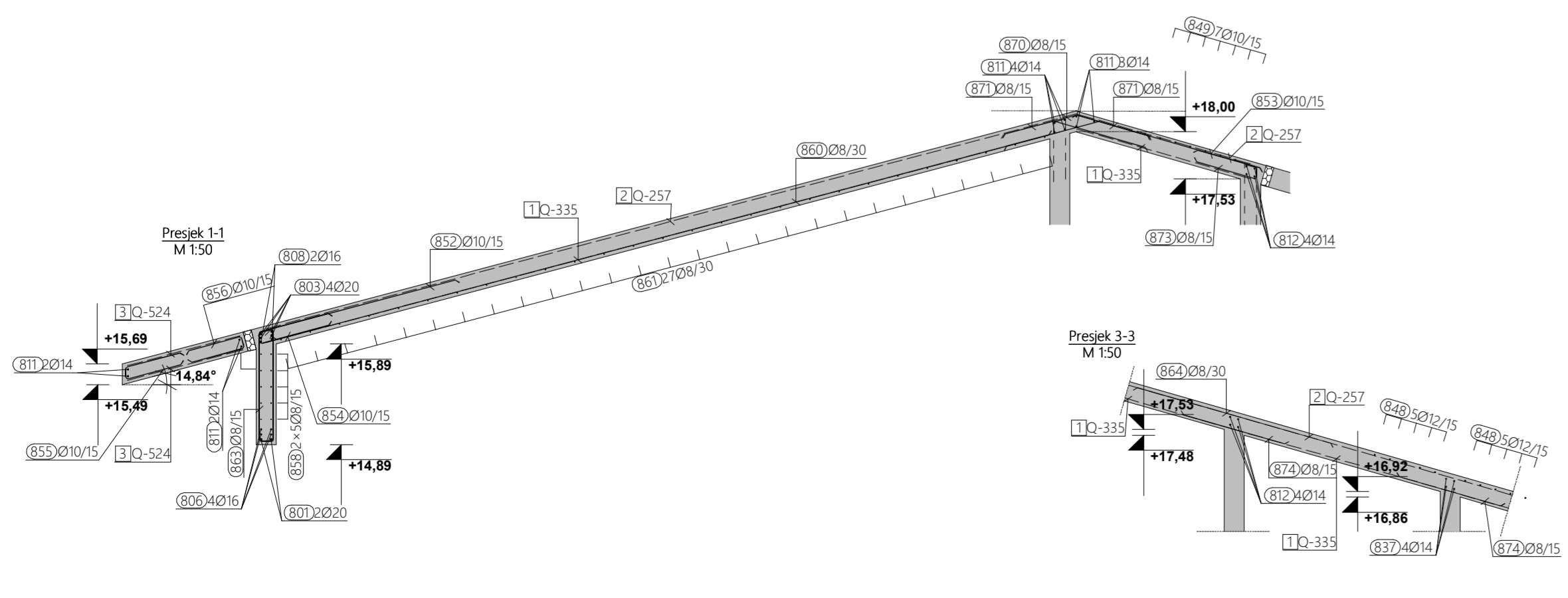

JAHAČI - 2 KOM / m²
 PLOČA d=20 cm

JAHAČI - 2 KOM / m²
 PLOČA d=20 cm

NAPOMENA
 Šipke prilagoditi i po potrebi rezi na licu mjesta. Preklap 50Z.

NAPOMENA
 Sve dimenzije provjeriti prema važećim planovima oplata.

Klasa betona	C 25/30
Armatura	B 500 B
Zaštitni sloj betona	
dijelje	gore
3,0 cm	3,0 cm
Pripadajuća lista armature: ARM_E3_601-603_JSKAZ	
Pripadajući armaturni nacrti	
ARM_E3_601-603	

KONSTRUKTA PEČAT I POTPIS:

KONSTRUKTA d.o.o. za projektiranje i nadzor
 Desinićka 20, ZAGREB, OIB: 06674378579
 ZR: PRIVREDNA BANKA 2340009-1110164468
 TEL: 0136 43 525; FAX: 0136 43 829
 MAIL: info@konstrukt.hr

INVESTITOR: TERME TUHELJI d.o.o. Uvedinča Gaja 4, Tuhejske Toplice, 49275 Tuhej
 GRADEVINA: REKONSTRUKCIJA TERMALNOG REKREACIJSKOG CENTRA TERME TUHELJI
 LOKACIJA: na k.č.br. 3199/1, k.o. Črešnjevec
 FAZA: IZVEDBENI PROJEKT - ARMATURNI NACRTI
 SADRŽAJ: ELEMENT - SMJEŠTAJNI PAVILJON ARMATURA KROVNE PLOČE GORNJA ZONA

GL. PROJEKTANT: Tomislav Vrdel, dipl. ing. arh.
 PROJEKT. IZV. PR: Antonio Maglov, dipl. ing. grad.
 IZRADIO: Antonio Maglov, dipl. ing. grad.
 DATUM: srpanj 2023.
 MJERILO: 1:50
 REVIZIJU: 09
 NACRT BR: **ARM - E3 - 602**

1 KROVNA PLOČA SMJEŠTAINOG PAVILIONA
NACRT SAVIJANJA RUBNE ARMATURE I ANKERA
M 1:50

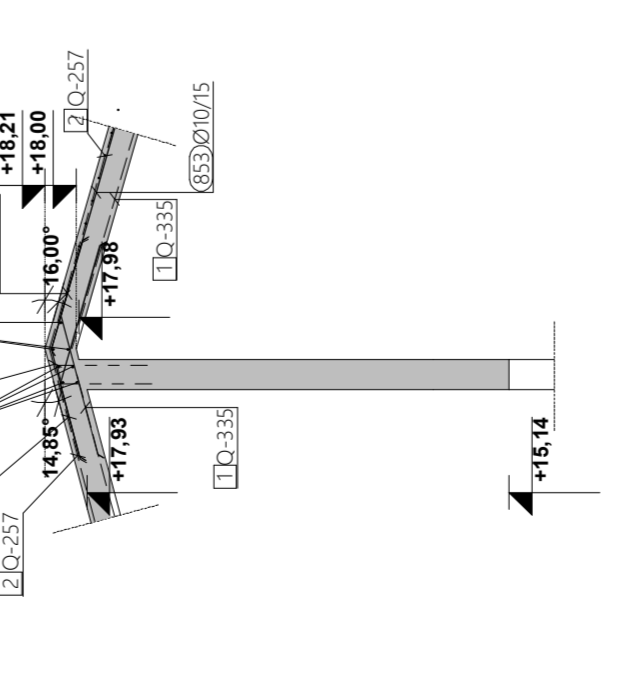
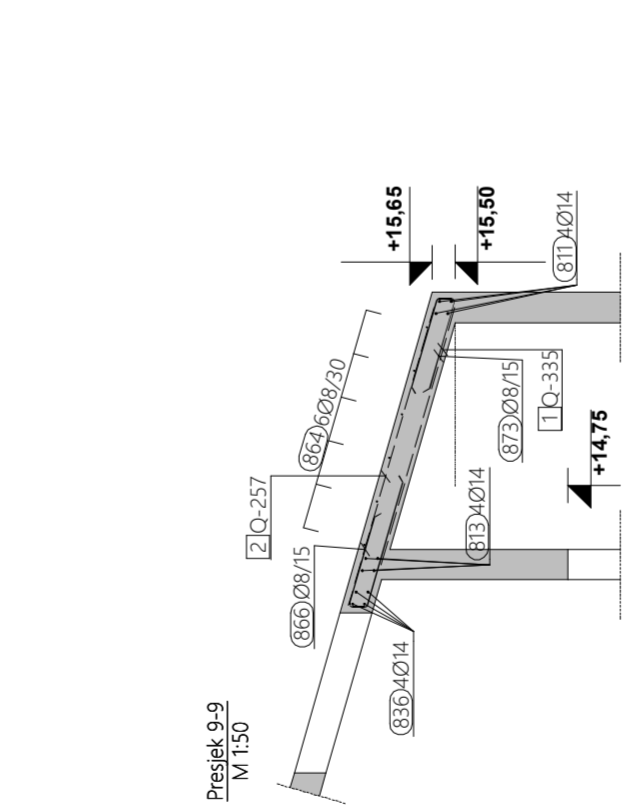
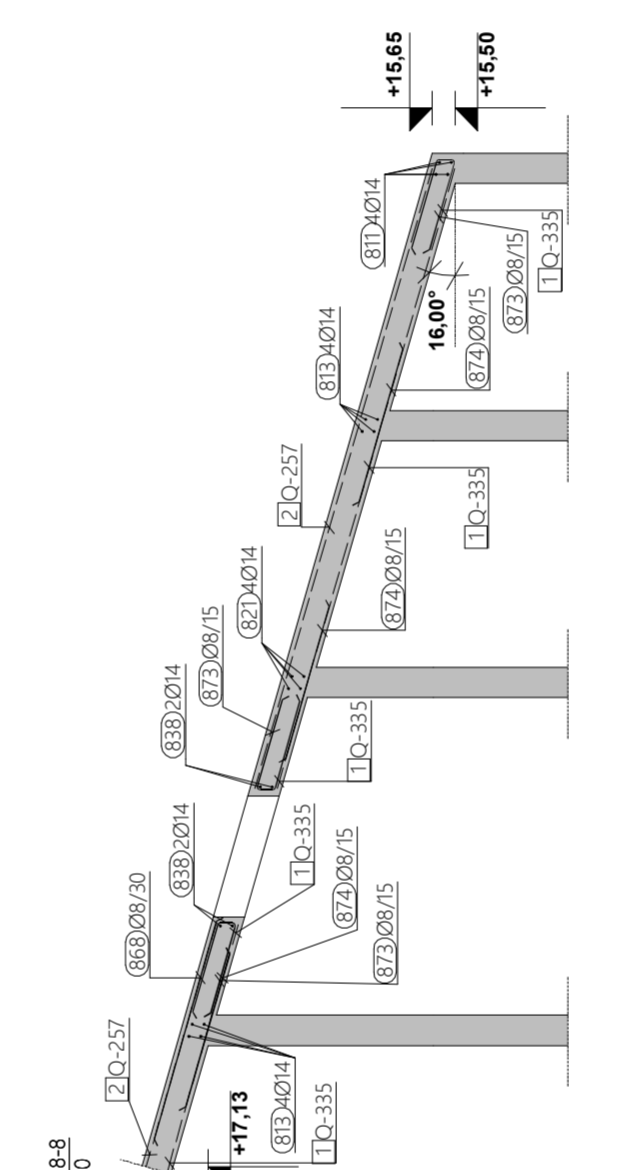
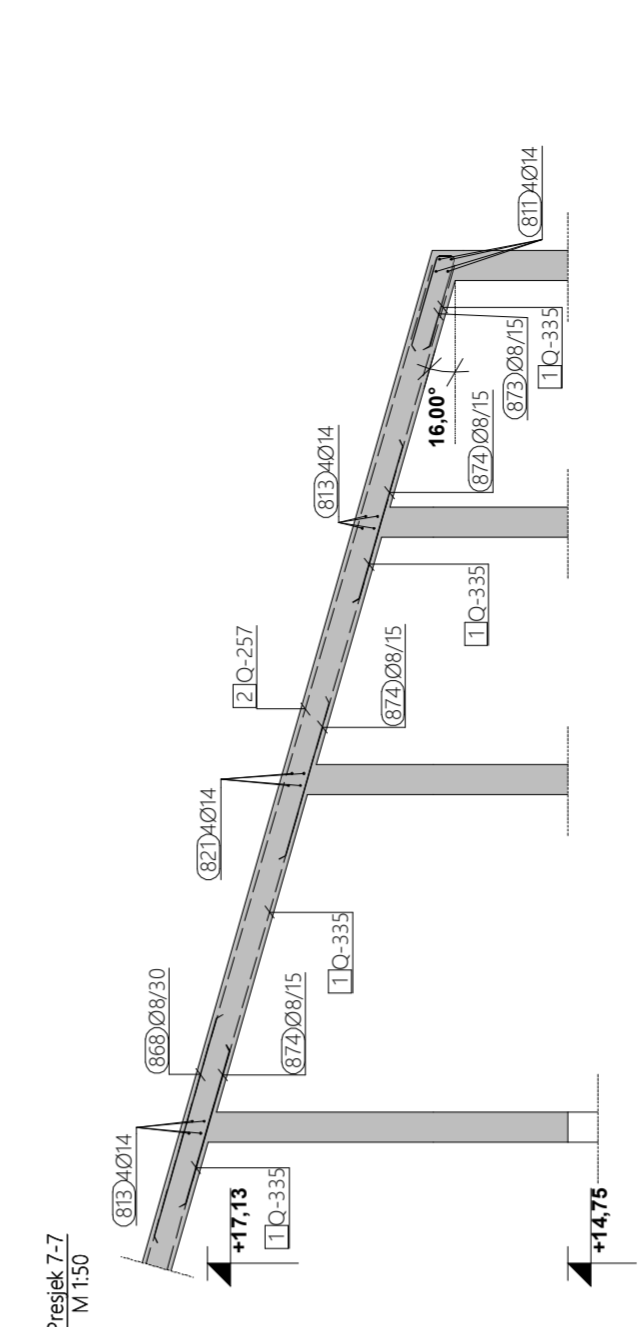
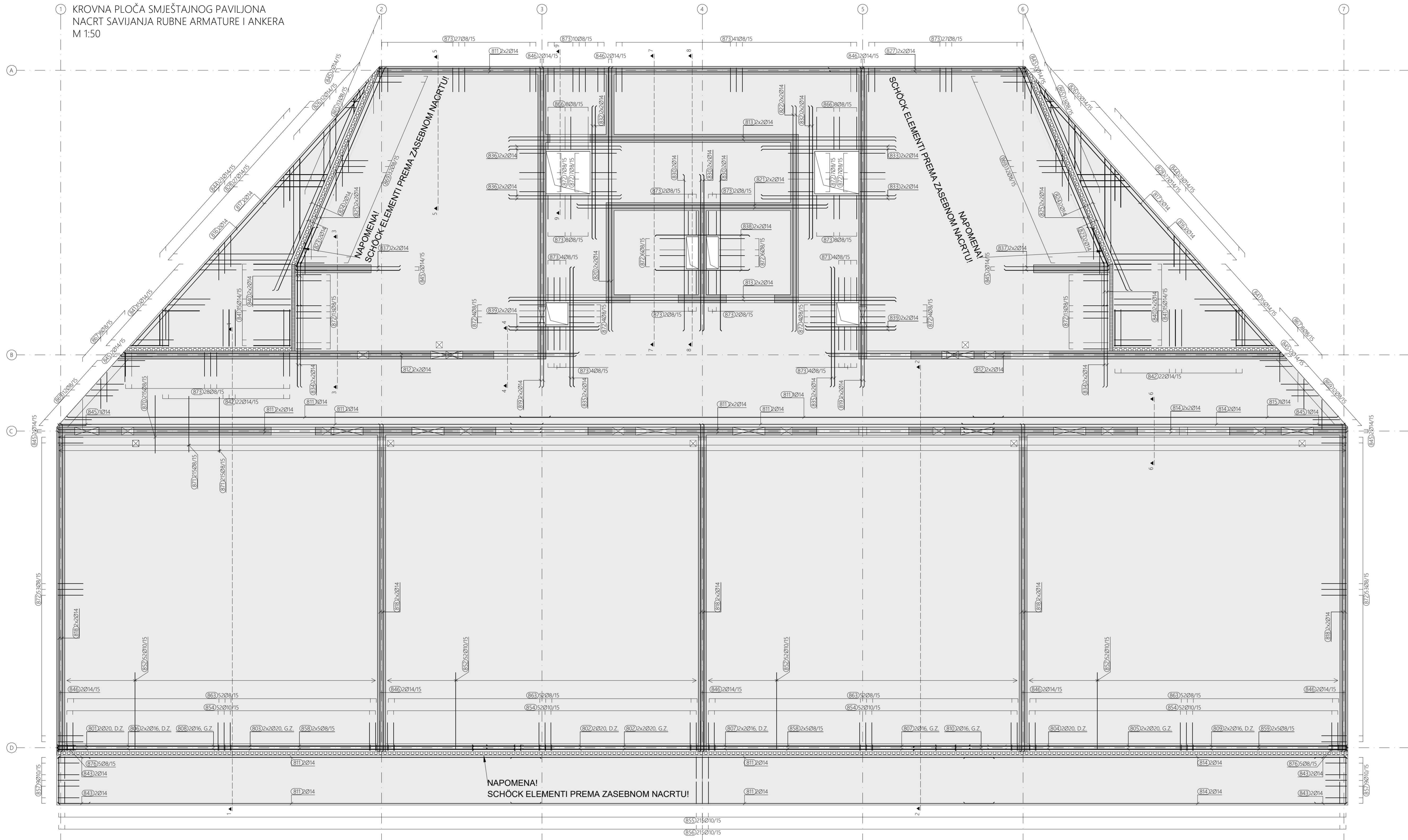

Šipke - specifikacija

ozn.	odlik i mjere (cm)	Ø (mm)	l (m)	n (kom)	lgn (m)
Armatura krovnih ploče (1 kom)					
801	1335	20	12,00	2	24,00
802	1070	20	12,00	6	72,00
803	1005	20	12,00	4	48,00
804	945	20	11,40	2	22,80
805	1075	16	11,40	4	45,60
806	1150	16	12,00	4	48,00
807	1002	16	12,00	6	72,00
808	1052	16	12,00	2	24,00
809	922	16	10,70	4	42,80
810	1000	16	10,70	2	21,40
811	1200	14	12,00	26	312,00
812	1130	14	11,30	8	90,40
813	960	14	9,60	8	76,80
814	950	14	9,50	10	95,00
815	905	14	9,05	1	9,05
816	885	14	8,85	4	35,40
817	850	14	8,50	4	34,00
818	840	14	8,40	20	168,00
819	825	14	8,25	8	66,00
820	880	14	6,80	4	27,20
821	620	14	6,20	4	24,80
822	580	14	5,80	4	23,20
823	560	14	5,60	4	22,40
824	540	14	5,40	4	21,60
825	535	14	5,35	8	42,80
826	a	14	*2,94	2 x 12	70,48
827	a	14	4,85	4	19,40
828	a	14	*2,83	2 x 27	153,00
829	a	14	*2,54	4 x 23	234,04
830	400	14	4,00	8	32,00
831	a	14	*3,01	4 x 15	180,88
832	340	14	3,40	8	27,20
833	330	14	3,30	8	26,40
834	320	14	3,20	8	25,60
835	305	14	3,05	8	24,40
836	275	14	2,75	8	22,00
837	255	14	2,55	8	20,40
838	230	14	2,30	4	9,20
839	220	14	2,20	8	17,60
840	100	14	2,00	8	16,00
841	93	14	2,00	60	120,00

842	92	14	1,95	44	85,80
843	90	14	1,90	8	15,20
844	75	14	1,70	46	78,20
845	78	14	1,70	18	30,60
846	76	14	1,65	16	26,40
847	77	12	4,00	156	624,00
848	340	12	3,40	20	68,00
849	a	10	*5,10	2 x 7	71,36
850	517	10	5,17	14	72,38
851	220	10	2,20	20	44,00
852	200	10	2,00	272	544,00
853	190	10	1,90	56	106,40
854	71	10	1,55	208	322,40
855	57	10	1,25	215	268,75
856	54	10	1,20	215	258,00
857	53	10	1,20	18	21,60
858	1200	8	12,00	20	240,00
859	890	8	8,90	10	89,00
860	795	8	7,95	54	429,30
861	700	8	7,00	54	378,00
862	600	8	6,00	52	312,00
863	111	8	2,65	208	551,20
864	200	8	2,00	77	154,00
865	79	8	1,70	26	44,20
866	62	8	1,60	16	25,60
867	74	8	1,60	16	25,60
868	150	8	1,50	15	22,50
869	68	8	1,50	88	132,00
870	64	8	1,50	215	322,50
871	95	8	1,45	430	623,50
872	63	8	1,40	188	263,20
873	62	8	1,35	173	233,55
874	105	8	1,05	206	216,30
875	100	8	1,00	272	272,00
876	44	8	1,00	10	10,00
877	25	8	0,95	508	881,60
878	25	8	0,91	48	43,68

NAPOMENA
Šipke prilagoditi i po potrebi reziati na licu mjesta. Preklop 500.

NAPOMENA
Sve dimenzije provjeriti prema važećim planovima optate.

Klasa betona	C 25/30
Armatura	B 500 B
Zaštitni sloj betona	3,0 cm
Prilagodjena lista armature:	ARM_E3_601-603_JS_KAZ
Prilagodjena armaturni nacrti	ARM_E3_601-602

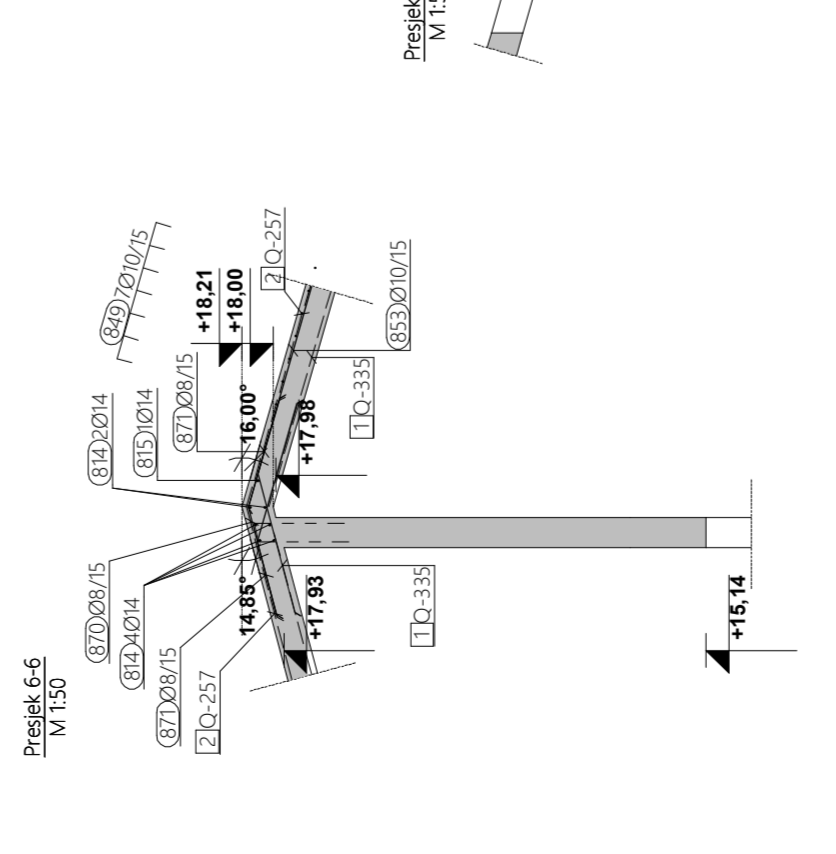
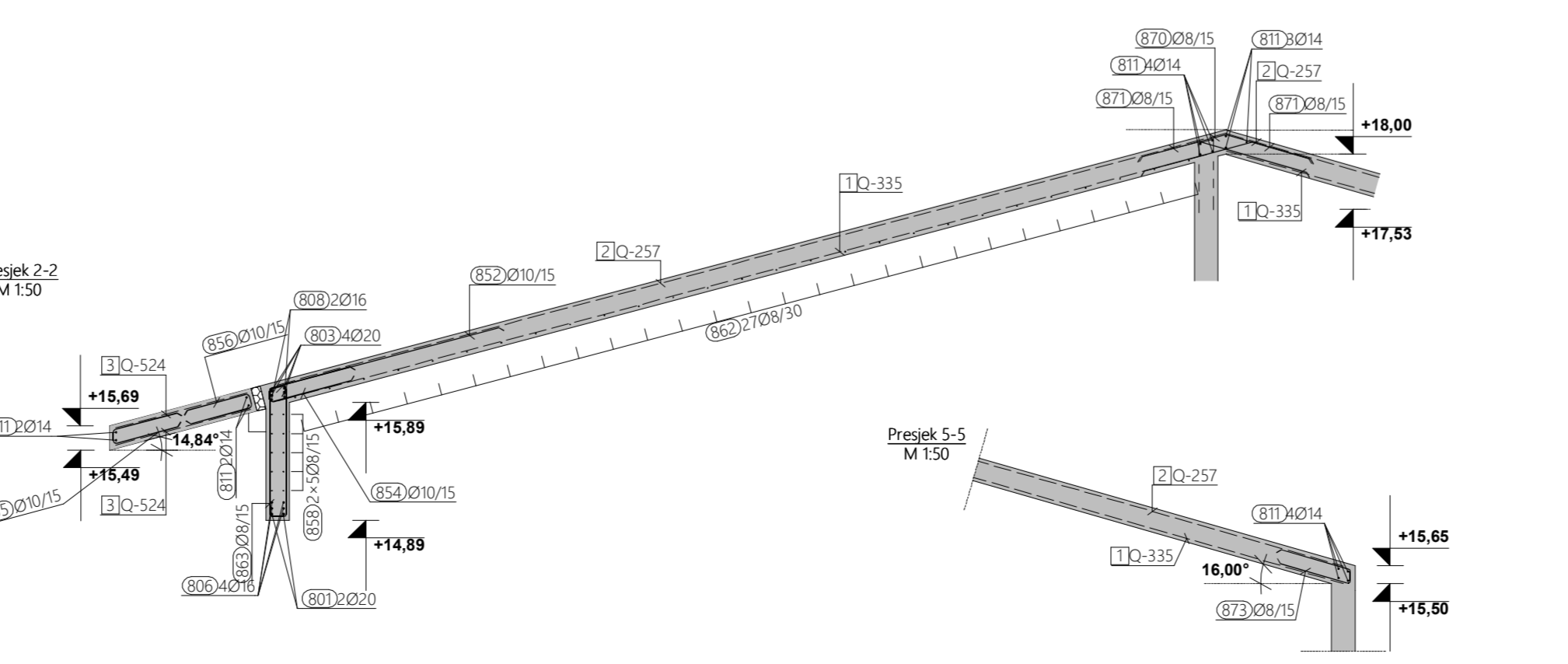
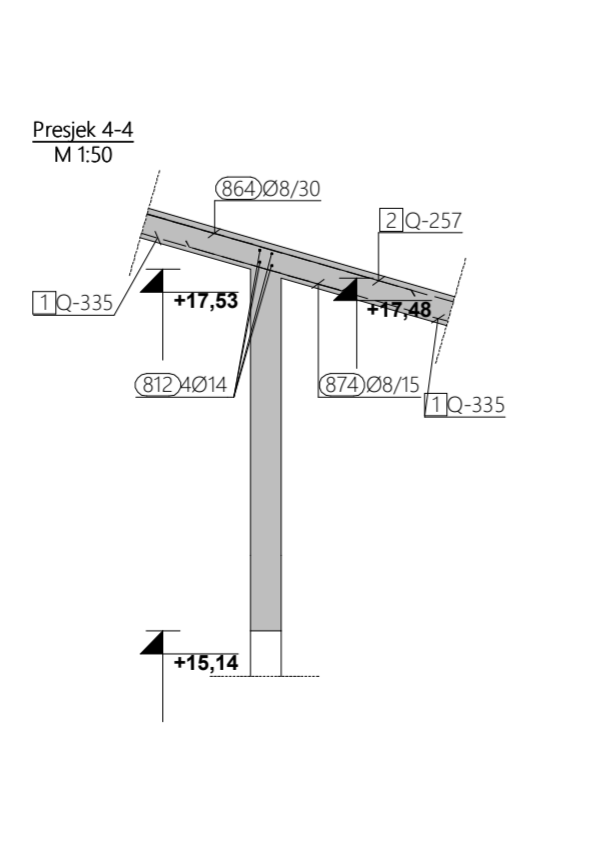
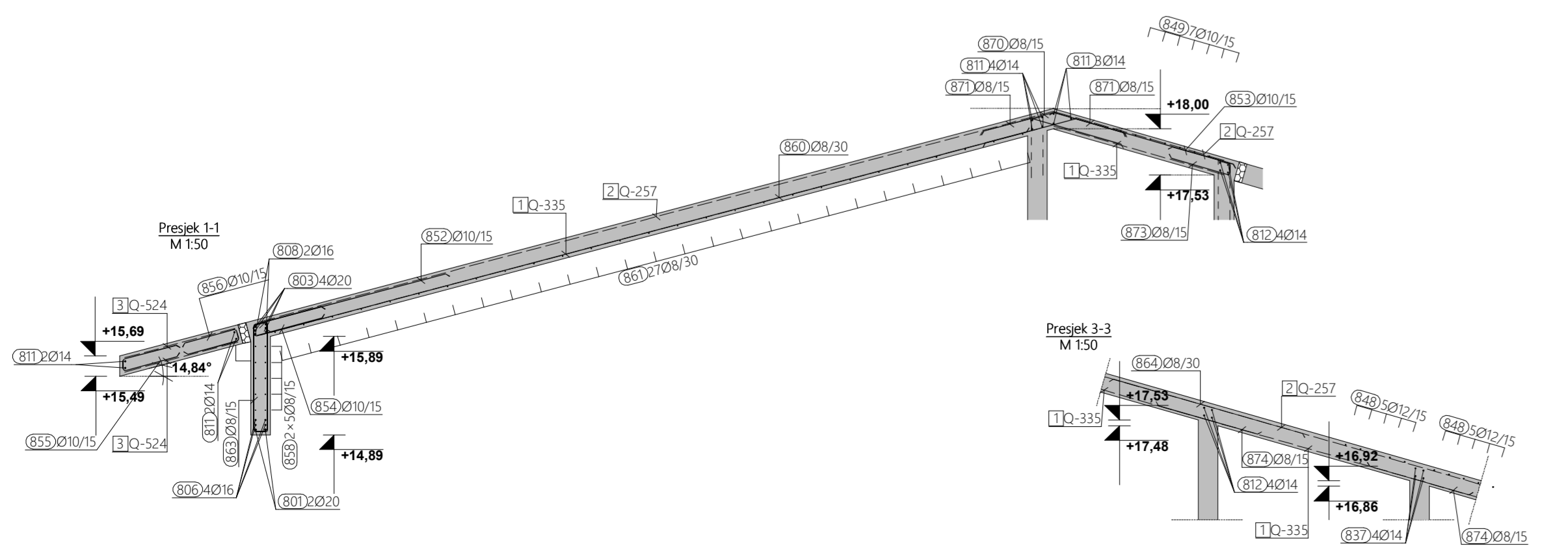

JAHAČI - 2 KOM / m²
PLOČA d=20 cm

JAHAČI - 2 KOM / m²
PLOČA d=20 cm

KONSTRUKTA PEČAT I POTPIS:

KONSTRUKTA d.o.o. za projektiranje i nadzor
Desinićeva 20, ZAGREB, OIB: 06674378579
Zr: PRIVREDNA BANKA 2340009-1110164468
TEL: 0136 43 826; FAX: 0136 75 43 829
MAIL: info@konstrukt.hr

INVESTITOR: TERME TUHELJI d.o.o. Uspjevnika Gopa 4, Tuhejske Toplice, 49275 Tuhej
GRAĐEVINA: REKONSTRUKCIJA TERMALNOG REKREACIJSKOG CENTRA TERME TUHELJI
LOKACIJA: na k.č.br. 3199/1, k.o. Črešnjevec



GL. PROJEKTANT: Tomislav Vrh, dipl. ing. arh.
PROJEKT. IZV. PR: Antonio Maglov, dipl. ing. grad.
IZRADIO: Antonio Maglov, dipl. ing. grad.

FAZA: IZVEDBENI PROJEKT - ARMATURNI NACRTI
SADRŽAJ: ELEMENT - SMJEŠTAINI PAVILION ARMATURA KROVNE PLOČE RUBNA ARMATURA I ANKERI

DATUM: srpanj 2023.
MJESECI: 130
REVIZIJU: 09

NACRT BR: **ARM - E3 - 603**

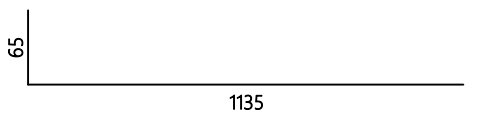

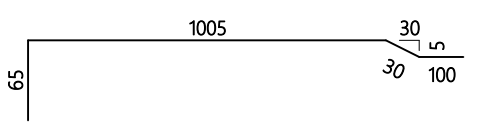
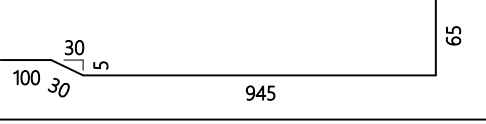
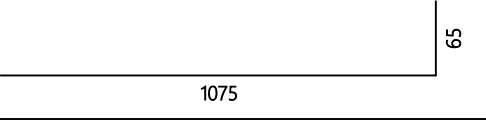
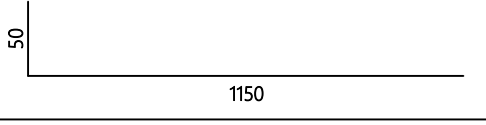
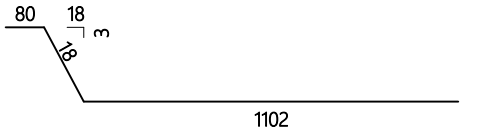
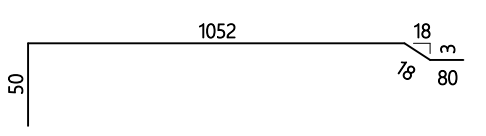
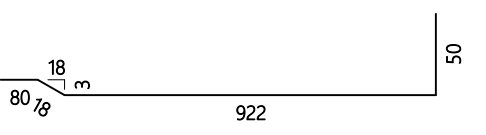
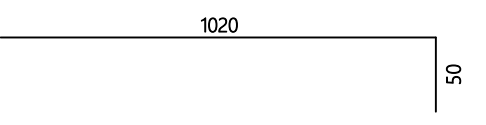
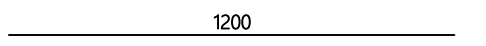
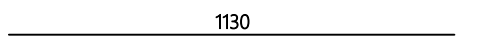
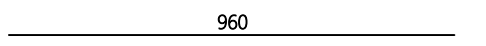
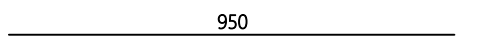

ISKAZ ARMATURE	
GRAĐEVINA:	REKONSTRUKCIJA TERMALNOG REKREACIJSKOG CENTRA TERME TUHELJ
ISKAZ UZ NACRT:	ARM_E3_601-603_0
SADRŽAJ:	ARMATURA KROVNE PLOČE
DATUM:	svibanj, 2023. 1/12

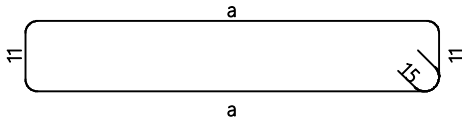
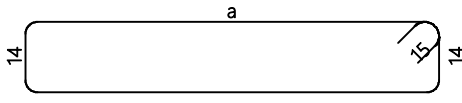
Šipke - specifikacija						
ozn	oblik i mjere [cm]	Ø	lg [m]	n [kom]	lgn [m]	Napomena
Armatura krovne ploče (1 kom)						
801		20	12.00	2	24.00	
802		20	12.00	6	72.00	
803		20	12.00	4	48.00	
804		20	11.40	2	22.80	
805		20	11.40	4	45.60	
806		16	12.00	4	48.00	
807		16	12.00	6	72.00	
808		16	12.00	2	24.00	
809		16	10.70	4	42.80	
810		16	10.70	2	21.40	
811		14	12.00	26	312.00	
812		14	11.30	8	90.40	
813		14	9.60	8	76.80	
814		14	9.50	10	95.00	

ISKAZ ARMATURE		
GRAĐEVINA:	REKONSTRUKCIJA TERMALNOG REKREACIJSKOG CENTRA TERME TUHELJ	
ISKAZ UZ NACRT:	ARM_E3_601-603_0	
SADRŽAJ:	ARMATURA KROVNE PLOČE	
DATUM:	svibanj, 2023.	2/12

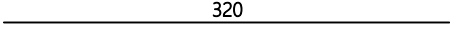
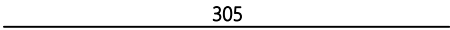
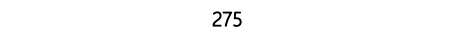
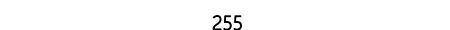
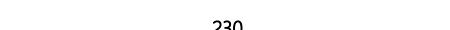
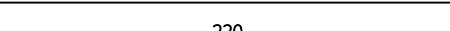
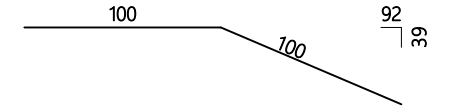
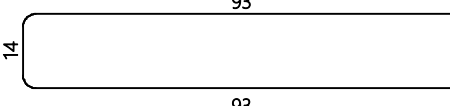
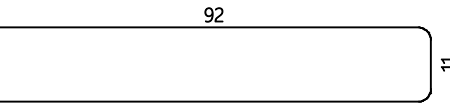
Šipke - specifikacija						
ozn	oblik i mjere [cm]	Ø	lg [m]	n [kom]	lgn [m]	Napomena
815	_____ 905 _____	14	9.05	1	9.05	
816	_____ 885 _____	14	8.85	4	35.40	
817	_____ 850 _____	14	8.50	4	34.00	
818	_____ 840 _____	14	8.40	20	168.00	
819	_____ 825 _____	14	8.25	8	66.00	
820	_____ 680 _____	14	6.80	4	27.20	
821	_____ 620 _____	14	6.20	4	24.80	
822	_____ 580 _____	14	5.80	4	23.20	
823	_____ 560 _____	14	5.60	4	22.40	
824	_____ 540 _____	14	5.40	4	21.60	
825	_____ 535 _____	14	5.35	8	42.80	
826	 <p>2 x : a = 20, 38, 57, 75, 93, 112, 130, 148, 167, 185, 203, 222</p>	14	*2.94	2 x 12	70.48	
827	_____ 485 _____	14	4.85	4	19.40	
828	 <p>2 x : a = 20, 27, 34, 41, 49, 56, 63, 70, 77, 84, 91, 98, 106, 113, 120, 127, 134, 141, 148, 155, 163, 170, 177, 184, 191, 198, 205</p>	14	*2.83	2 x 27	153.00	
829	_____ a _____ 4 x : a = 70, 87, 104, 120, 137, 154, 171, 187, 204, 221, 238, 254, 271, 288, 305, 321, 338, 355, 372, 388, 405, 422, 439	14	*2.54	4 x 23	234.04	
830	_____ 400 _____	14	4.00	8	32.00	
831	_____ a _____ 4 x : a = 393, 380, 367, 354, 341, 328, 315, 301, 288, 275, 262, 249, 236, 223, 210	14	*3.01	4 x 15	180.88	
832	_____ 340 _____	14	3.40	8	27.20	
833	_____ 330 _____	14	3.30	8	26.40	

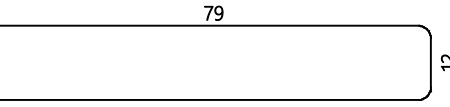
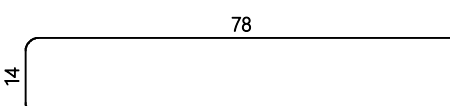
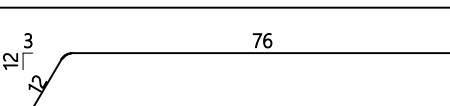
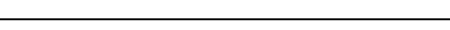
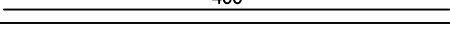
ISKAZ ARMATURE		
GRAĐEVINA:	REKONSTRUKCIJA TERMALNOG REKREACIJSKOG CENTRA TERME TUHELJ	
ISKAZ UZ NACRT:	ARM_E3_601-603_0	
SADRŽAJ:	ARMATURA KROVNE PLOČE	
DATUM:	svibanj, 2023.	3/12

Šipke - specifikacija						
ozn	oblik i mjere [cm]	Ø	lg [m]	n [kom]	lgn [m]	Napomena
834		14	3.20	8	25.60	
835		14	3.05	8	24.40	
836		14	2.75	8	22.00	
837		14	2.55	8	20.40	
838		14	2.30	4	9.20	
839		14	2.20	8	17.60	
840		14	2.00	8	16.00	
841		14	2.00	60	120.00	
842		14	1.95	44	85.80	
843		14	1.90	8	15.20	
844		14	1.70	46	78.20	
845		14	1.70	18	30.60	
846		14	1.65	16	26.40	
847		12	4.00	156	624.00	
848		12	3.40	20	68.00	
849	 2 x : a = 550, 537, 523, 510, 496, 483, 469	10	*5.10	2 x 7	71.36	
850		10	5.17	14	72.38	



ISKAZ ARMATURE

GRAĐEVINA:	REKONSTRUKCIJA TERMALNOG REKREACIJSKOG CENTRA TERME TUHELJ	
ISKAZ UZ NACRT:	ARM_E3_601-603_0	
SADRŽAJ:	ARMATURA KROVNE PLOČE	
DATUM:	svibanj, 2023.	4/12

Šipke - specifikacija						
ozn	oblik i mjere [cm]	Ø	lg [m]	n [kom]	lgn [m]	Napomena
851		10	2.20	20	44.00	
852		10	2.00	272	544.00	
853		10	1.90	56	106.40	
854		10	1.55	208	322.40	
855		10	1.25	215	268.75	
856		10	1.20	215	258.00	
857		10	1.20	18	21.60	
858		8	12.00	20	240.00	
859		8	8.90	10	89.00	
860		8	7.95	54	429.30	
861		8	7.00	54	378.00	
862		8	6.00	52	312.00	
863		8	2.65	208	551.20	
864		8	2.00	77	154.00	
865		8	1.70	26	44.20	
866		8	1.60	16	25.60	

ISKAZ ARMATURE

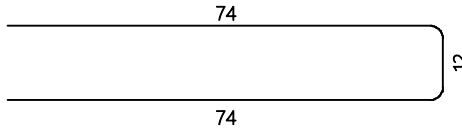
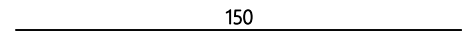
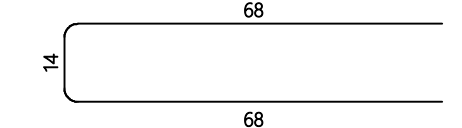
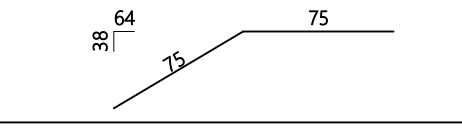
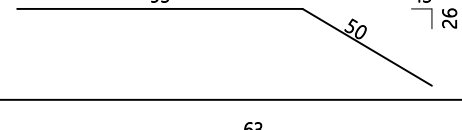
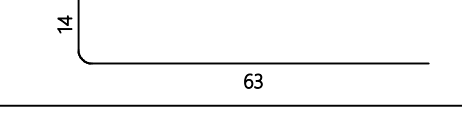
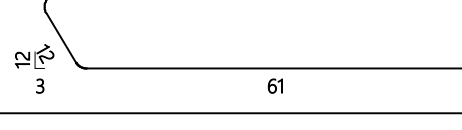
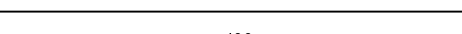
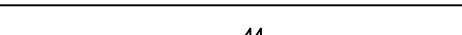
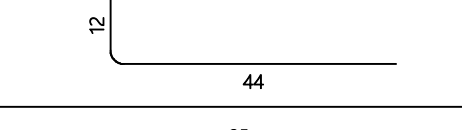
GRAĐEVINA:	REKONSTRUKCIJA TERMALNOG REKREACIJSKOG CENTRA TERME TUHELJ	
ISKAZ UZ NACRT:	ARM_E3_601-603_0	
SADRŽAJ:	ARMATURA KROVNE PLOČE	
DATUM:	svibanj, 2023.	5/12

Šipke - specifikacija						
ozn	oblik i mjere [cm]	Ø	lg [m]	n [kom]	lgn [m]	Napomena
867		8	1.60	16	25.60	
868		8	1.50	15	22.50	
869		8	1.50	88	132.00	
870		8	1.50	215	322.50	
871		8	1.45	430	623.50	
872		8	1.40	188	263.20	
873		8	1.35	173	233.55	
874		8	1.05	206	216.30	
875		8	1.00	272	272.00	
876		8	1.00	10	10.00	
877		8	0.95	928	881.60	
878		8	0.91	48	43.68	

ISKAZ ARMATURE		
GRAĐEVINA:	REKONSTRUKCIJA TERMALNOG REKREACIJSKOG CENTRA TERME TUHELJ	
ISKAZ UZ NACRT:	ARM_E3_601-603_0	
SADRŽAJ:	ARMATURA KROVNE PLOČE	
DATUM:	svibanj, 2023.	6/12

Šipke - rekapitulacija			
Ø [mm]	lgn [m]	Jedinična težina [kg/m']	Težina [kg]
B500B			
8	5269.73	0.40	2081.54
10	1708.89	0.62	1054.39
12	692.00	0.89	614.50
14	2283.45	1.21	2762.97
16	208.20	1.58	328.96
20	212.40	2.47	524.63
Ukupno (B500B)			7366.98
Ukupno			7366.98

ISKAZ ARMATURE		
GRAĐEVINA:	REKONSTRUKCIJA TERMALNOG REKREACIJSKOG CENTRA TERME TUHELJ	
ISKAZ UZ NACRT:	ARM_E3_601-603_0	
SADRŽAJ:	ARMATURA KROVNE PLOČE	
DATUM:	svibanj, 2023.	7/12

Mreže - specifikacija							
Pozicija	Oznaka mreže	B [cm]	L [cm]	n	Jedinična težina [kg/m ²]	Ukupna težina [kg]	Napomena
Armatura krovne ploče (1 kom)							
1	Q-335	215	600	18	5.38	1249.24	
1-4	Q-335	179	600	4	5.38	231.22	
1-5	Q-335	156	135	2	5.38	22.78	
1-6	Q-335	215	324	4	5.38	149.91	
1-7	Q-335	120	324	1	5.38	20.92	
1-8	Q-335	215	238	2	5.38	55.09	
1-9	Q-335	60	238	2	5.38	15.37	
1-10	Q-335	215	245	16	5.38	453.43	
1-11	Q-335	138	600	4	5.38	178.02	
1-12	Q-335	138	245	4	5.38	72.69	
1-14	Q-335	176	505	1	5.38	47.81	
1-15	Q-335	176	600	1	5.38	56.81	
1-16	Q-335	176	75	1	5.38	7.10	
1-17	Q-335	170	266	2	5.38	48.66	
1-18	Q-335	176	170	1	5.38	16.10	
1-19	Q-335	215	600	2	5.38	138.80	
1-20	Q-335	215	556	2	5.38	128.53	
1-21	Q-335	215	486	2	5.38	112.54	
1-22	Q-335	55	417	2	5.38	24.72	
2	Q-257	215	600	19	4.12	1009.81	
2-1	Q-257	215	280	17	4.12	422.39	
2-2	Q-257	178	280	2	4.12	41.03	
2-3	Q-257	178	600	2	4.12	87.76	
2-4	Q-257	179	600	2	4.12	88.53	
2-5	Q-257	98	84	2	4.12	6.77	
2-6	Q-257	215	600	4	4.12	212.59	
2-7	Q-257	155	359	2	4.12	45.90	
2-8	Q-257	215	359	4	4.12	127.24	
2-9	Q-257	215	564	2	4.12	99.96	
2-10	Q-257	215	396	2	4.12	70.24	
2-11	Q-257	142	417	1	4.12	24.41	
2-12	Q-257	142	544	1	4.12	31.80	
2-13	Q-257	215	476	1	4.12	42.14	
2-14	Q-257	215	483	1	4.12	42.82	
2-15	Q-257	215	401	1	4.12	35.48	
2-16	Q-257	215	560	1	4.12	49.62	
2-17	Q-257	215	544	1	4.12	48.15	

ISKAZ ARMATURE		
GRAĐEVINA:	REKONSTRUKCIJA TERMALNOG REKREACIJSKOG CENTRA TERME TUHELJ	
ISKAZ UZ NACRT:	ARM_E3_601-603_0	
SADRŽAJ:	ARMATURA KROVNE PLOČE	
DATUM:	svibanj, 2023.	8/12

Mreže - specifikacija							
Polozicija	Oznaka mreže	B [cm]	L [cm]	n	Jedinična težina [kg/m ²]	Ukupna težina [kg]	Napomena
2-18	Q-257	215	417	1	4.12	36.95	
3-1	Q-524	119	600	5	8.31	296.81	
3-2	Q-524	119	435	1	8.31	43.04	
3-3	Q-524	116	600	5	8.31	289.07	
3-4	Q-524	116	435	1	8.31	41.91	
Ukupno						6224.14	